

 **SCHONBEK** | 1870

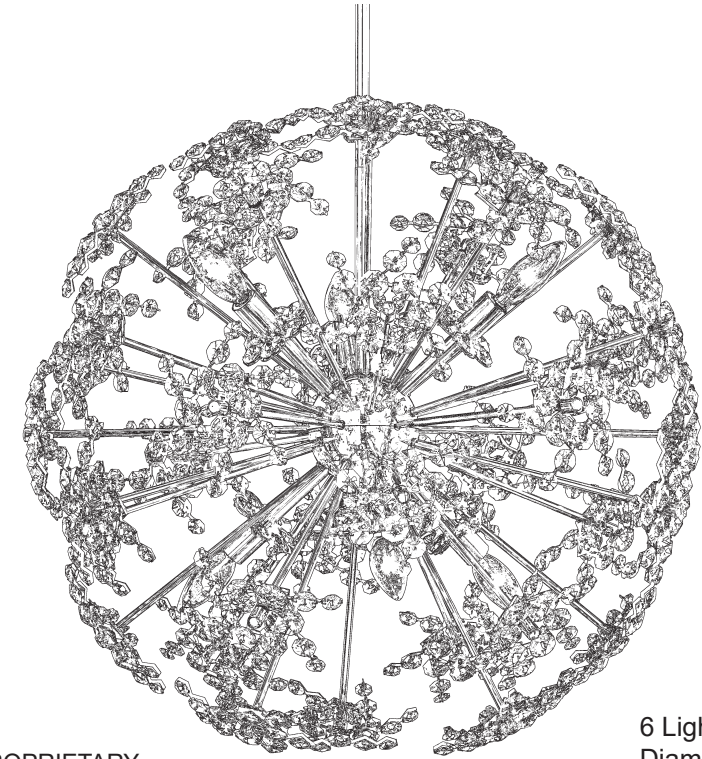









**ESTERACAE  
DN1024N- \_\_ \_R**



**T**HIS DESIGN IS THE PROPRIETARY  
TRADE DRESS/TRADEMARK OF  
W SCHONBEK LLC.

6 Lights  
Diameter: 24"  
Height: 24"  
Hanging Weight: 18lbs.

 **SCHONBEK** | 1870

			<b>S</b>						
MAX <b>60</b> W	110-120 V								

1

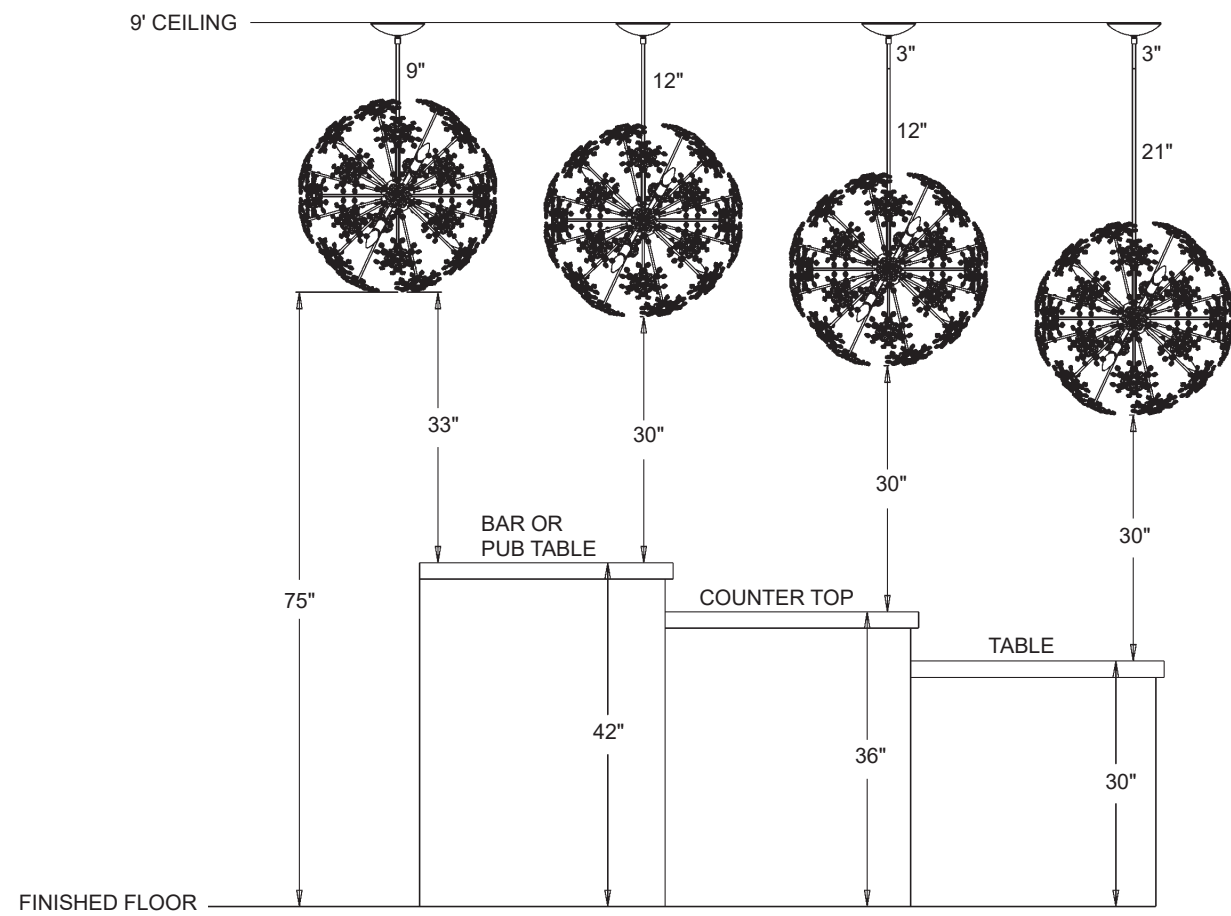
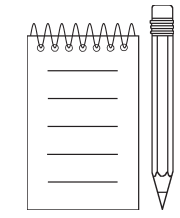
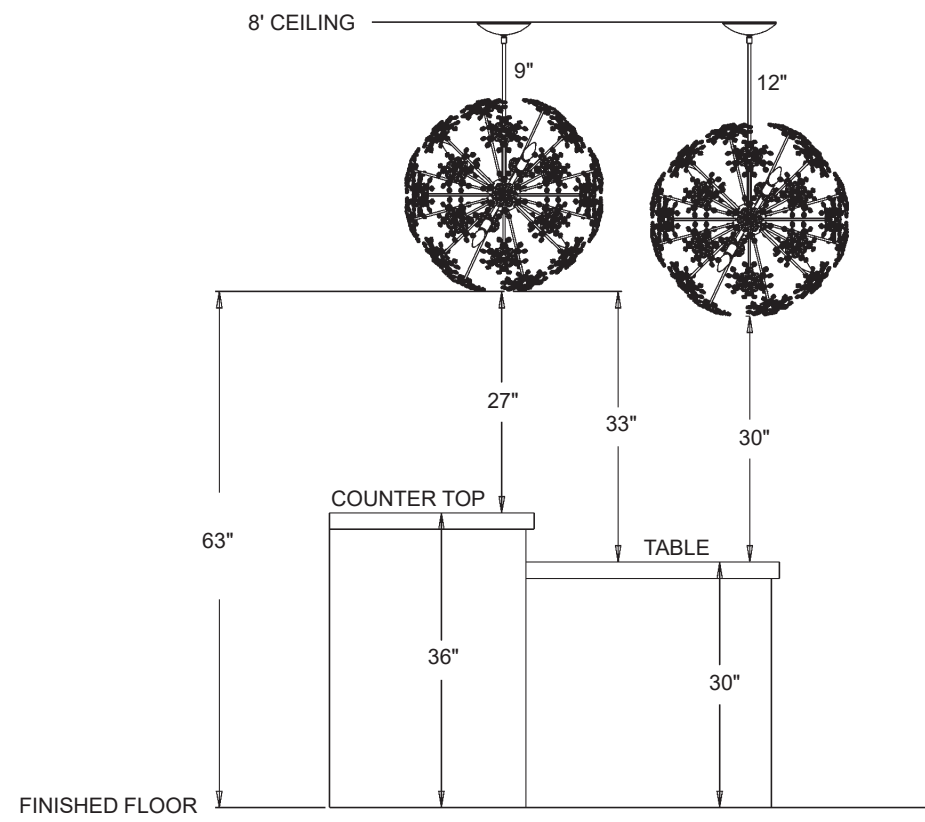

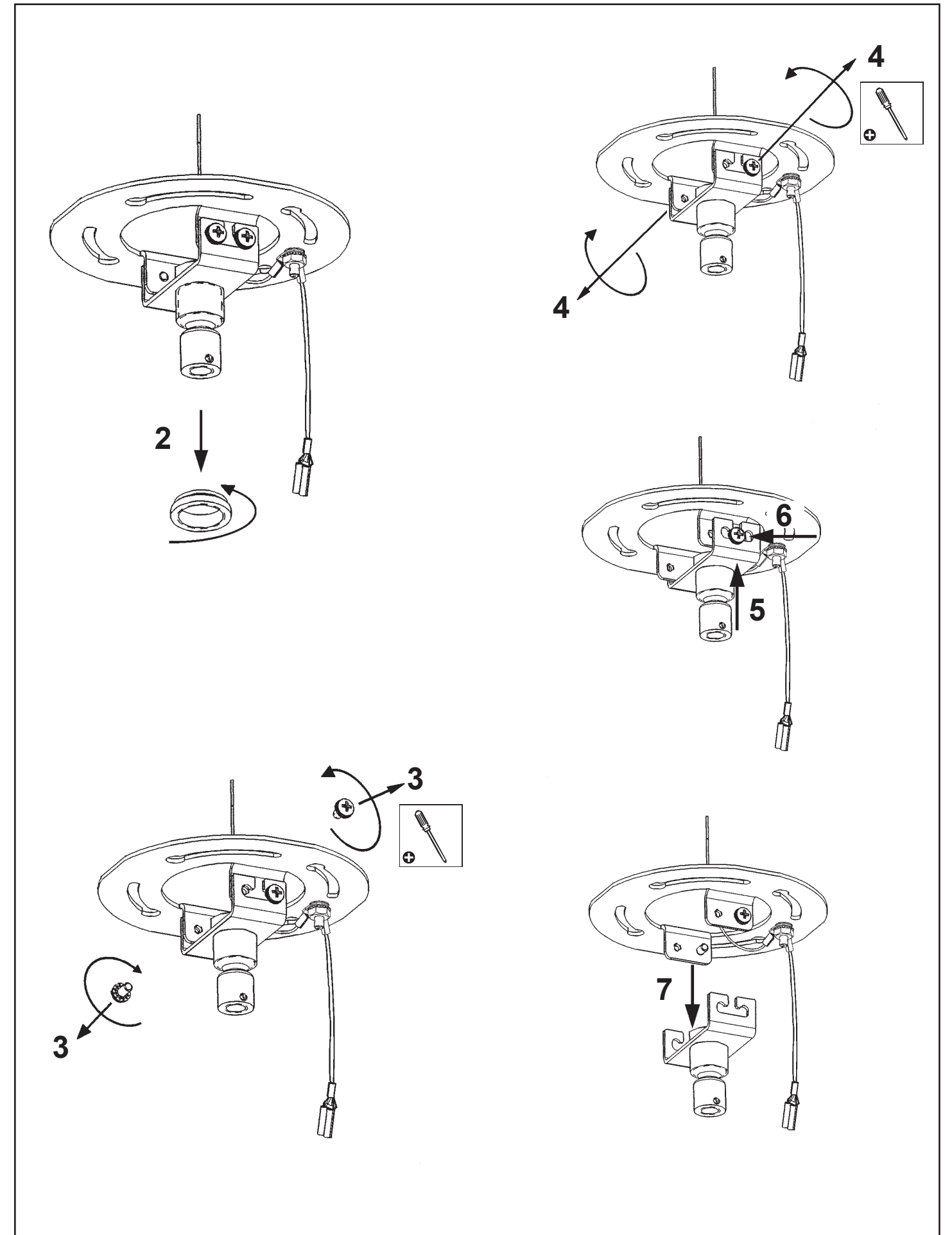
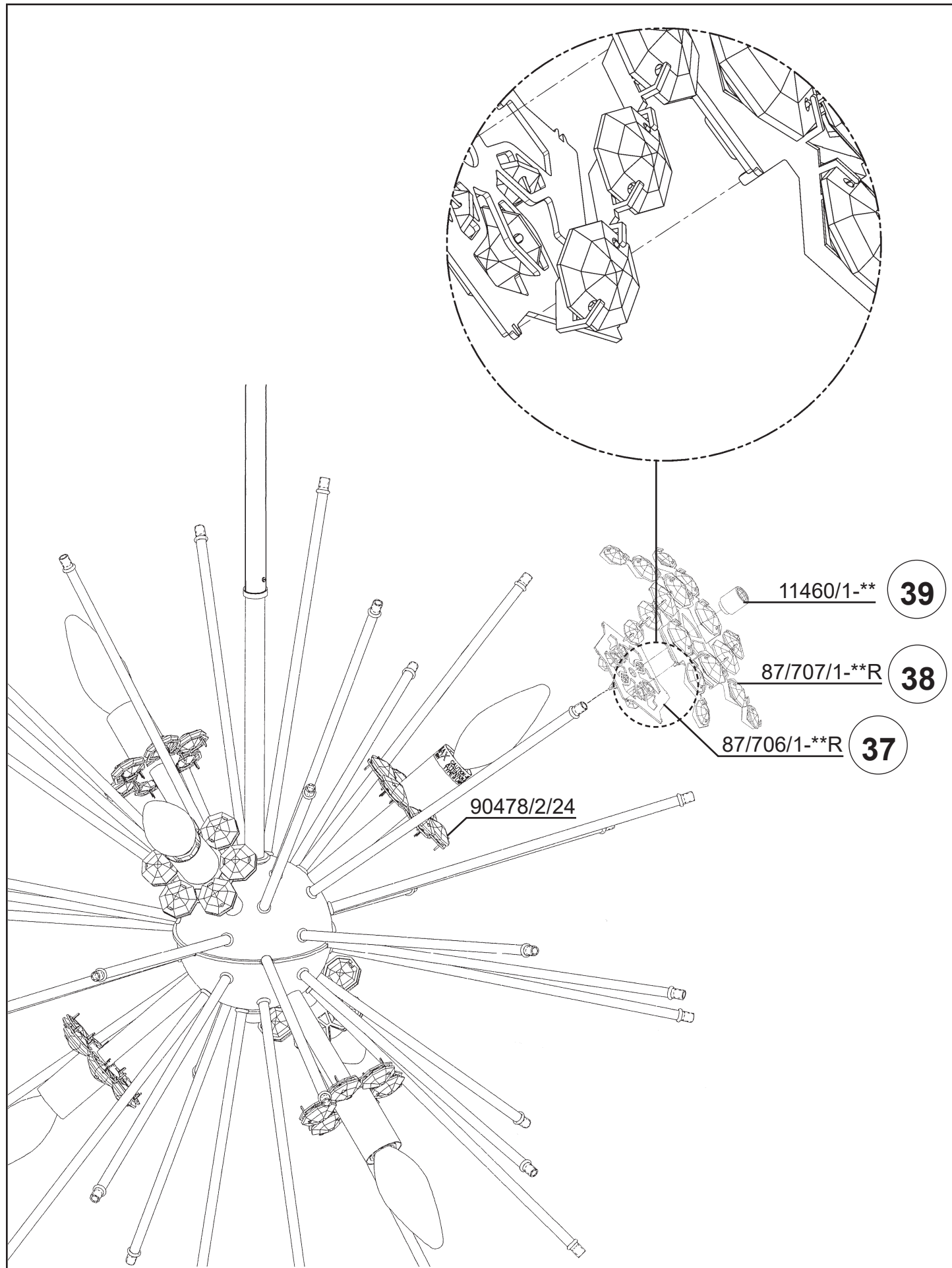

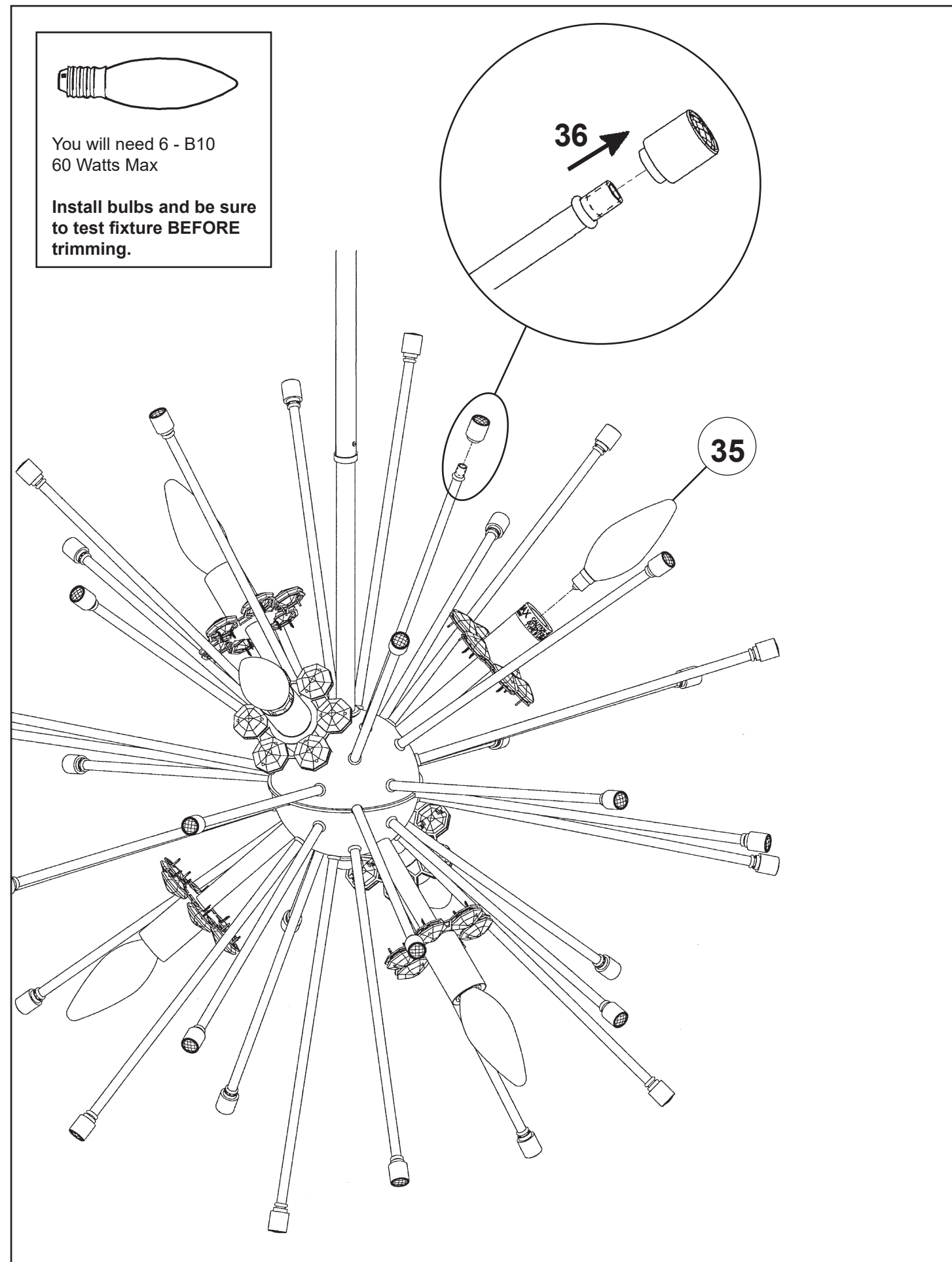
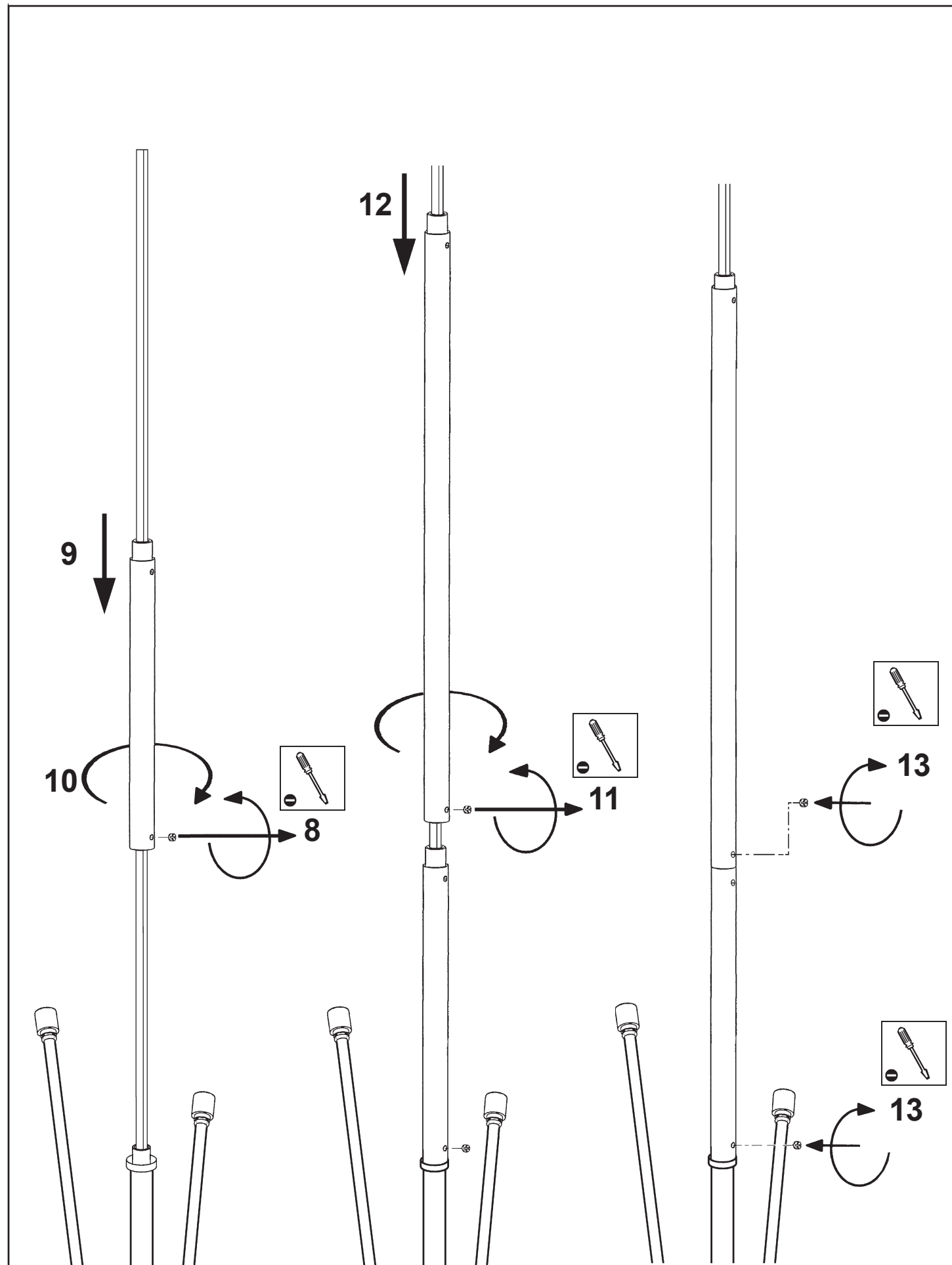

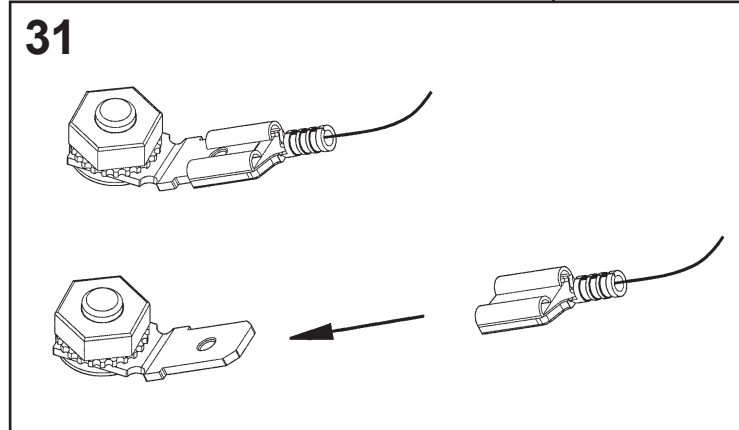
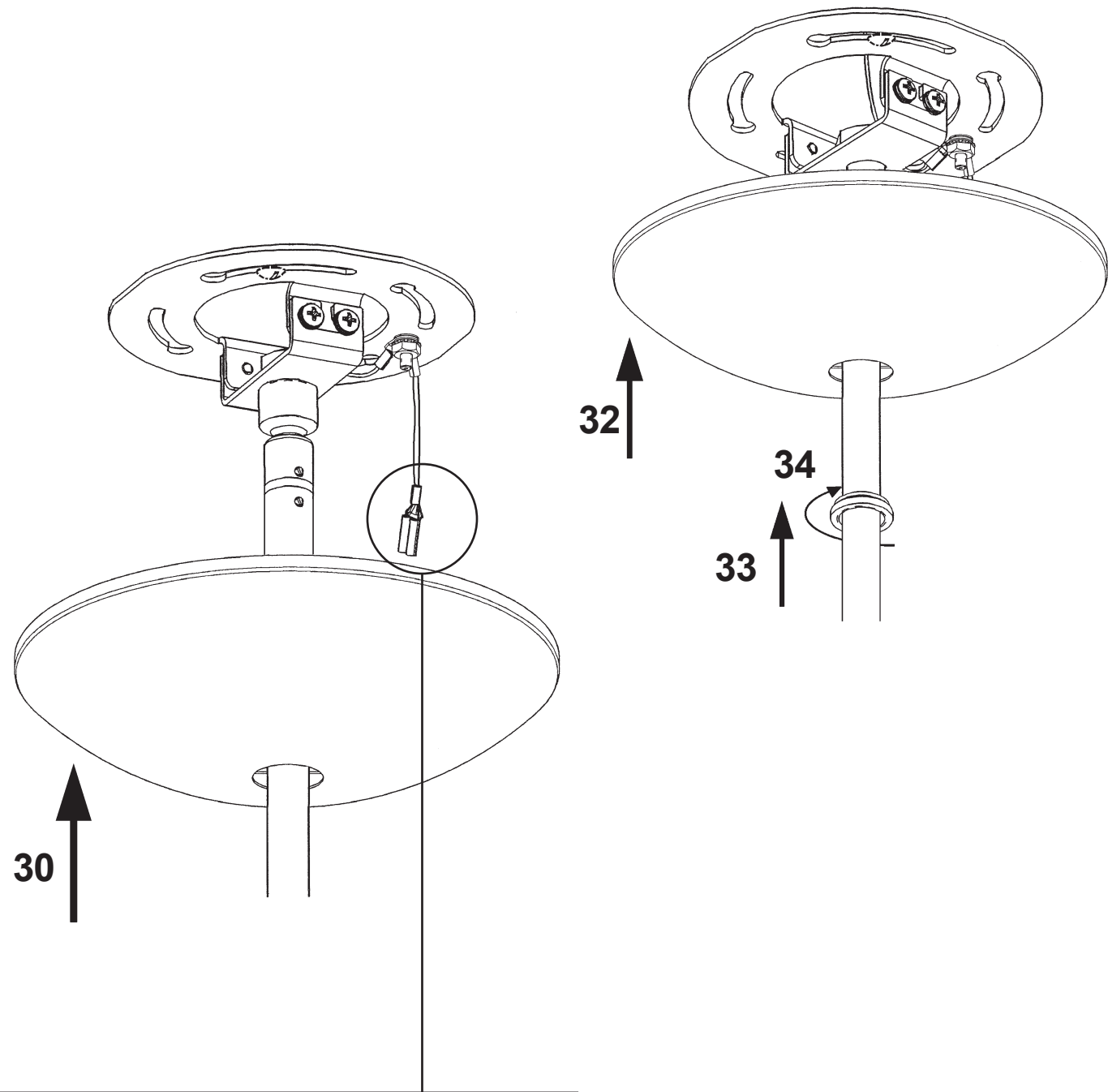

1 X  : 11384-\*\*

