

ESMERY AR1006N-\_\_ \_\_O

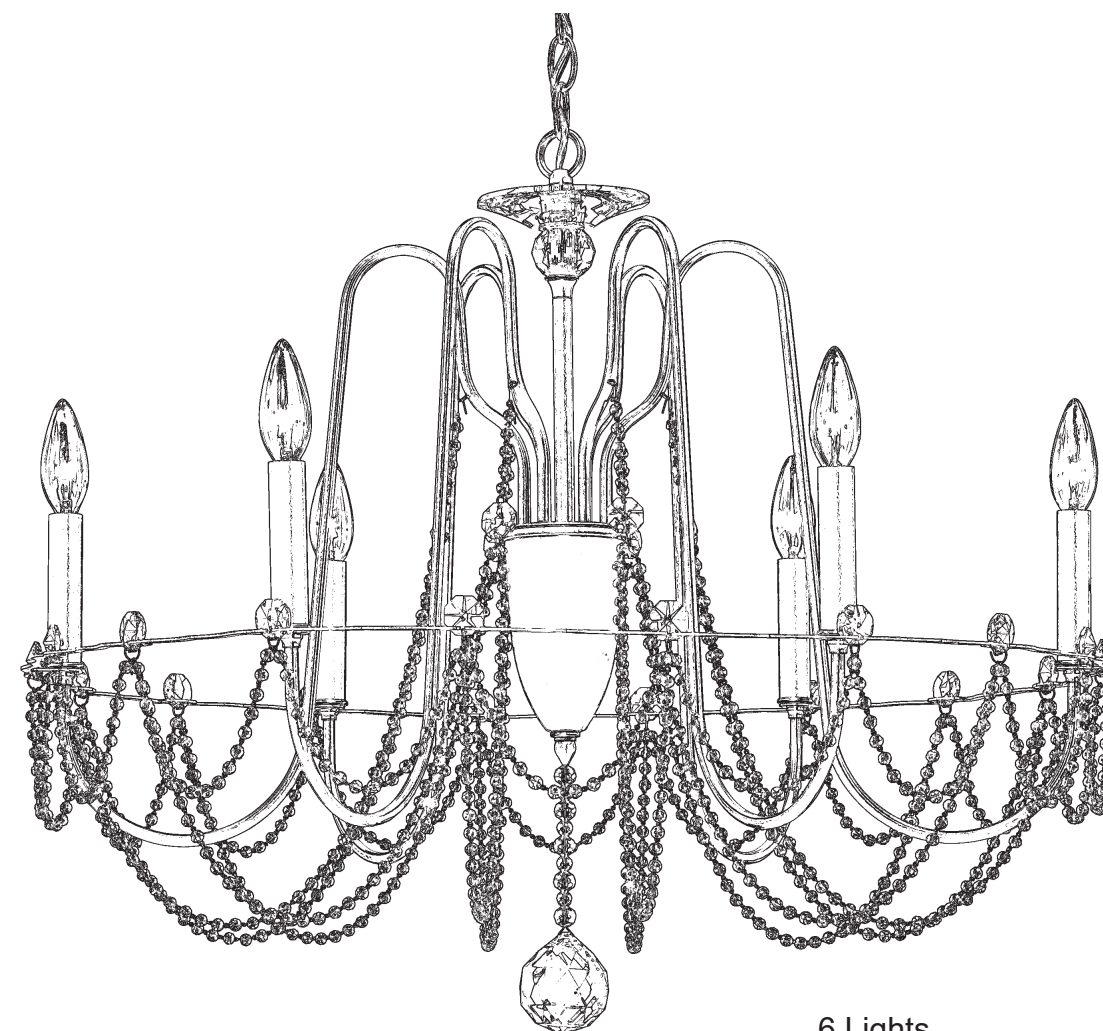











**T**HIS DESIGN IS THE PROPRIETARY  
TRADE DRESS/TRADemark OF  
W SCHONBEK LLC.

6 Lights  
Diameter: 28"  
Height: 24"  
Hanging Weight: 10lbs.

 **SCHONBEK** | 1870

 **SCHONBEK** | 1870

								
MAX 60 W	110-120 V							

**WARNING:**

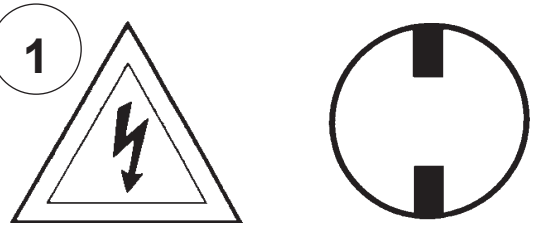
1 

**Electrical Danger Turn Power Off**

All electrical components must be installed by a licensed electrician in accordance with the National Electric Code and the appropriate local electrical codes.

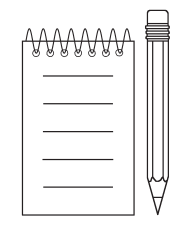
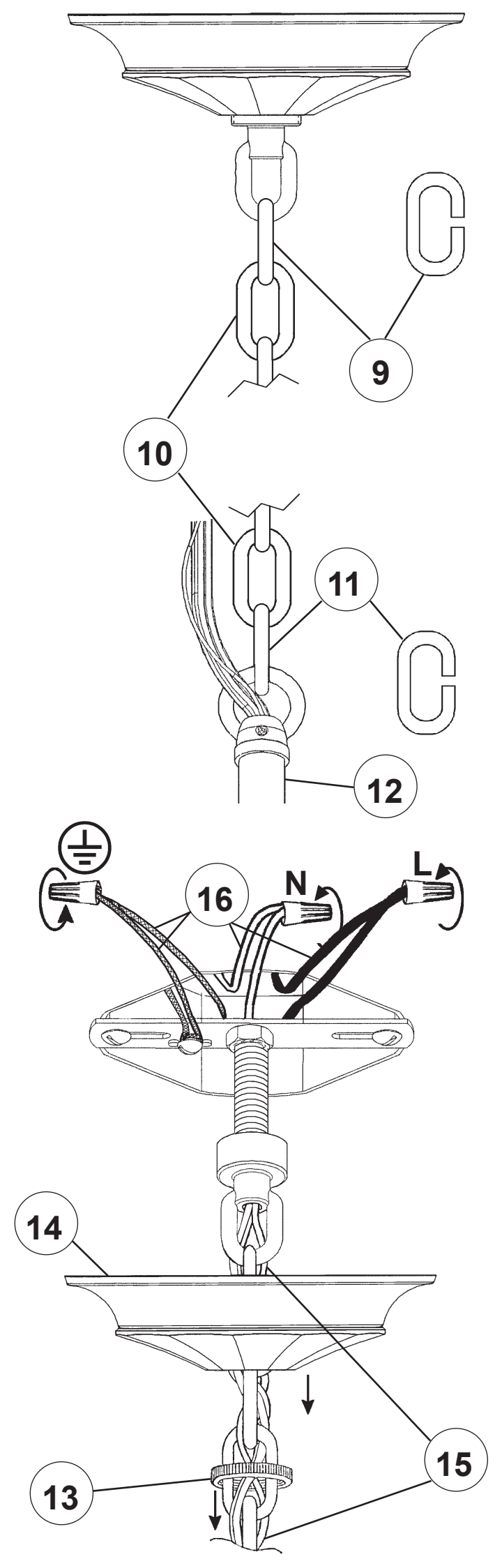
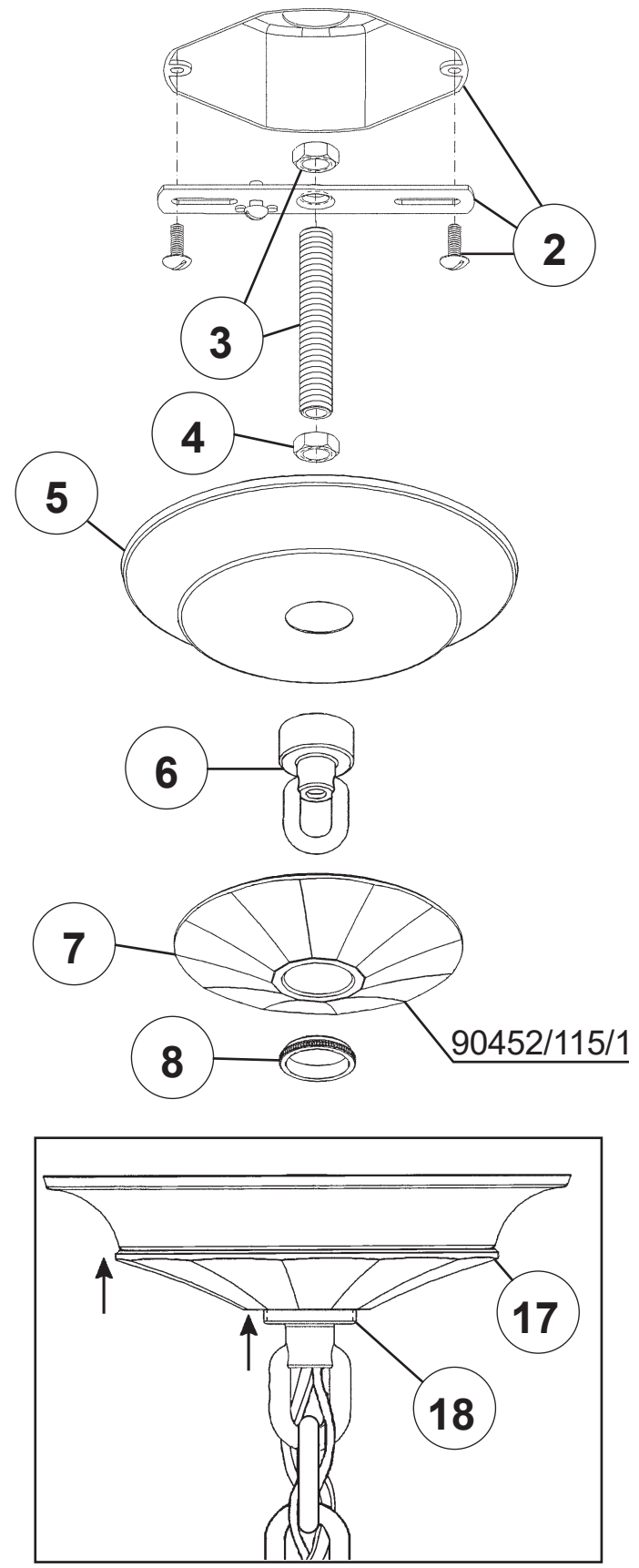

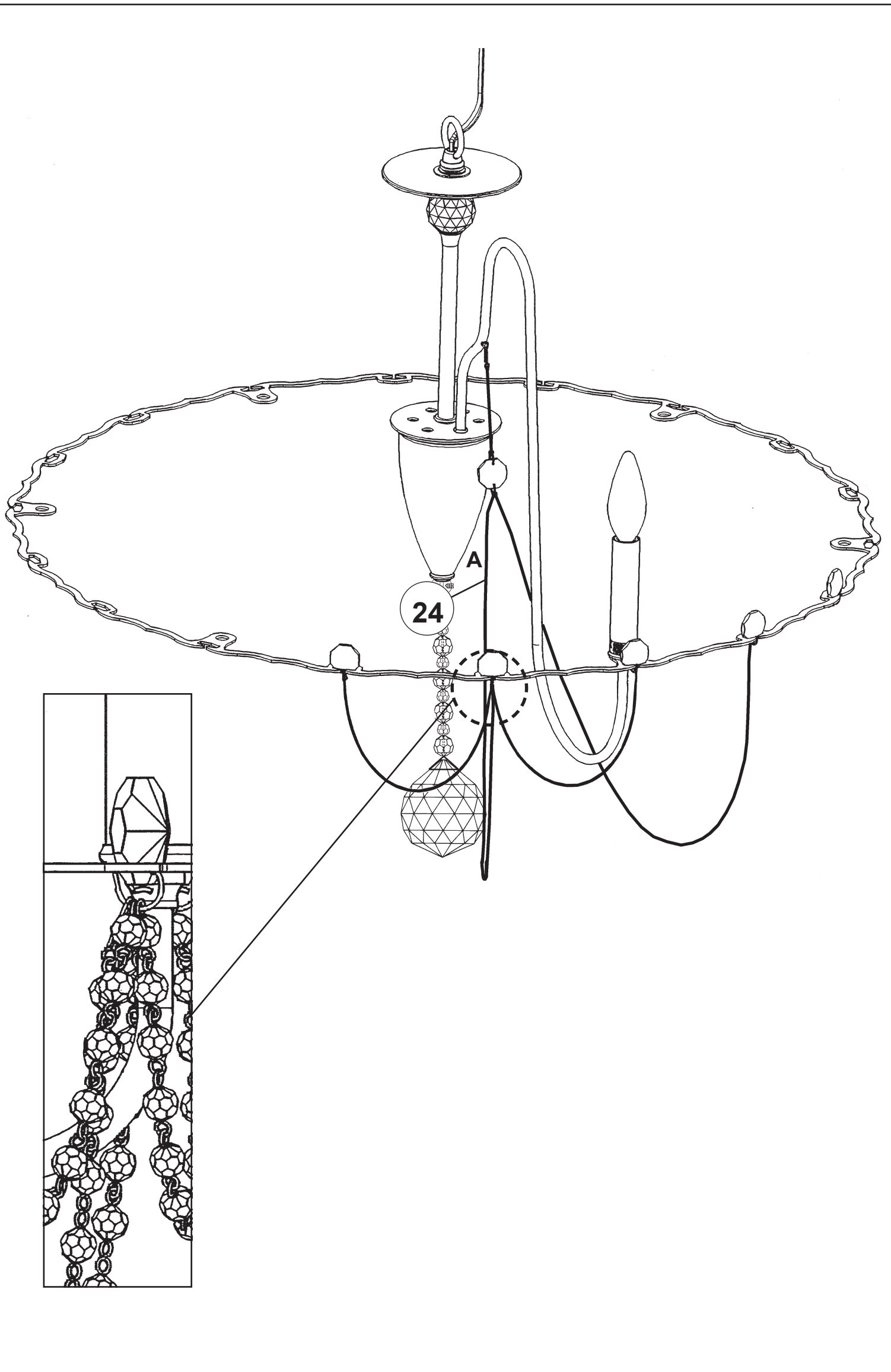

**19**

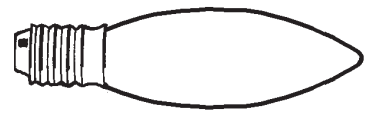

You will need 6 - B10  
25 Watts Recommended  
60 Watts Max

**Install bulbs and be sure  
to test fixture BEFORE  
trimming.**

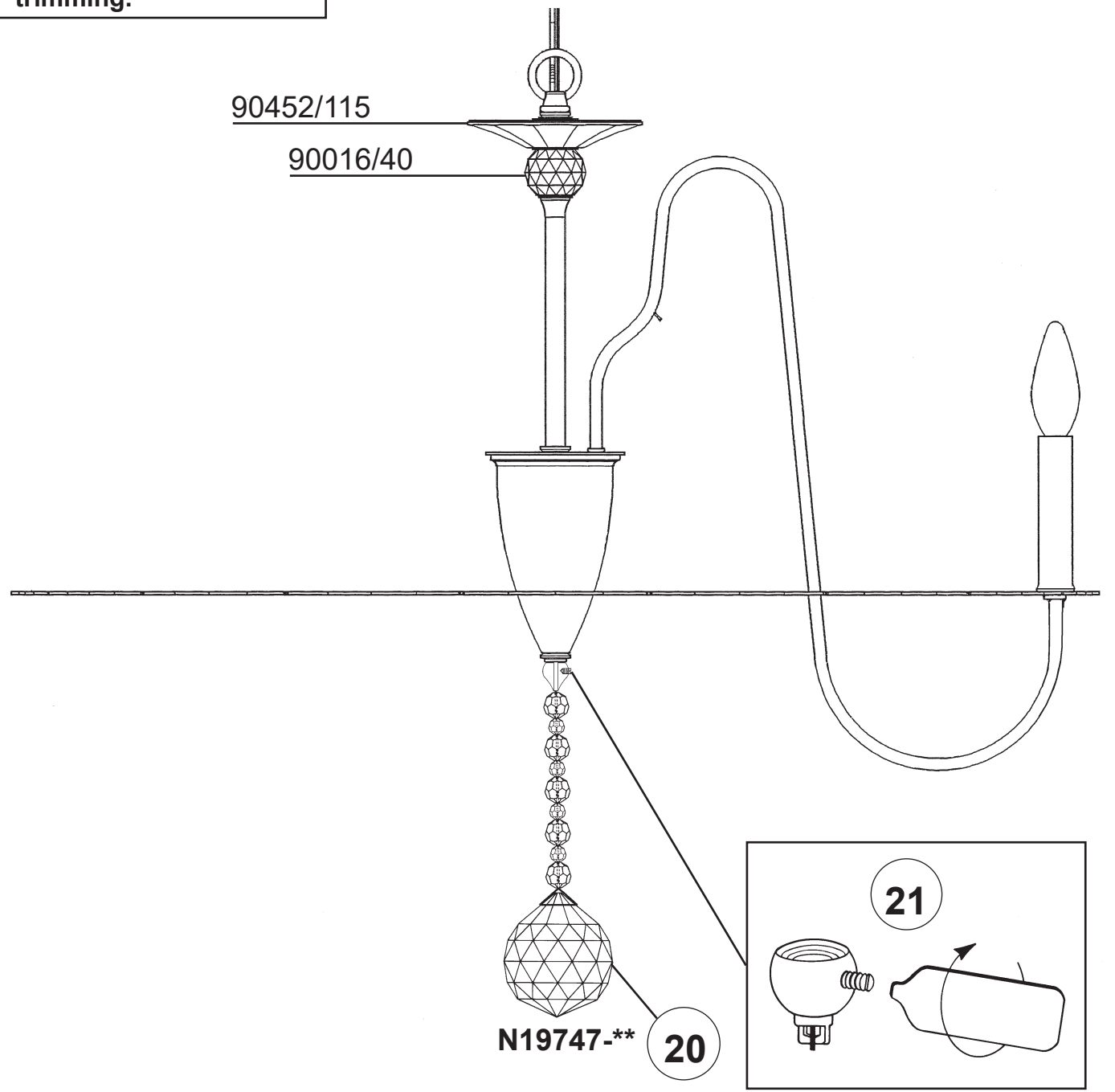

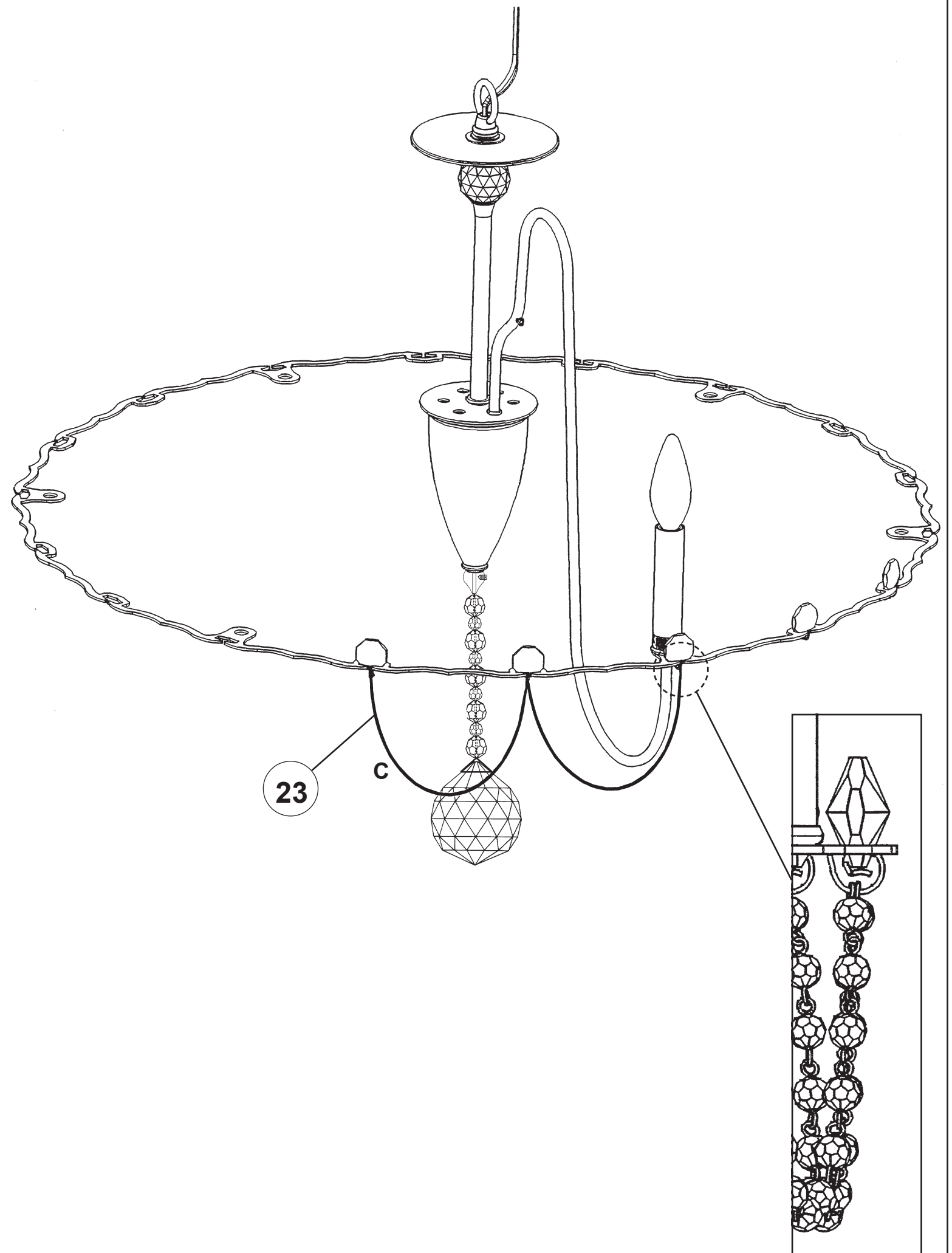
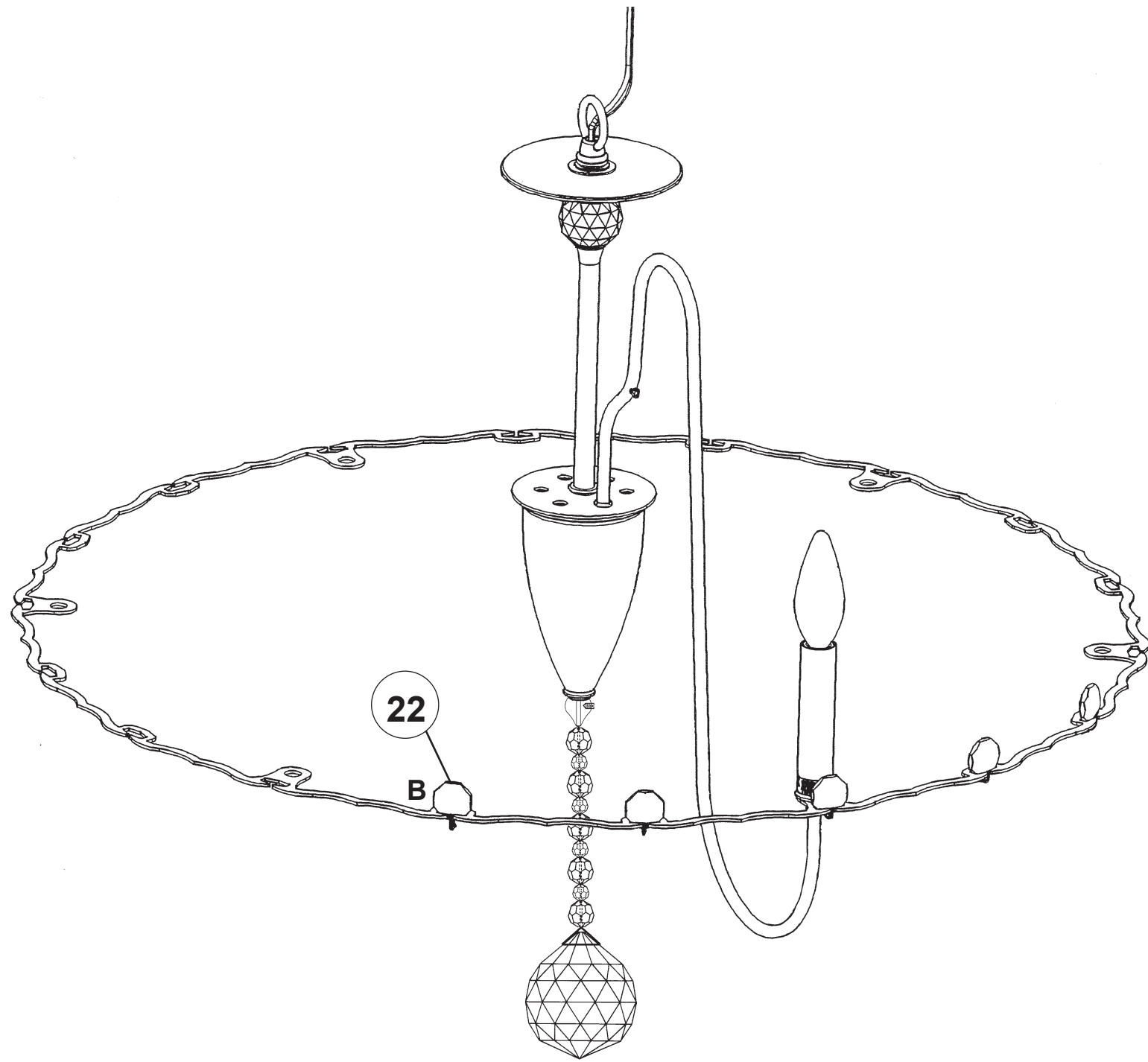

# ESMERY AR1006N-\_\_ \_\_S

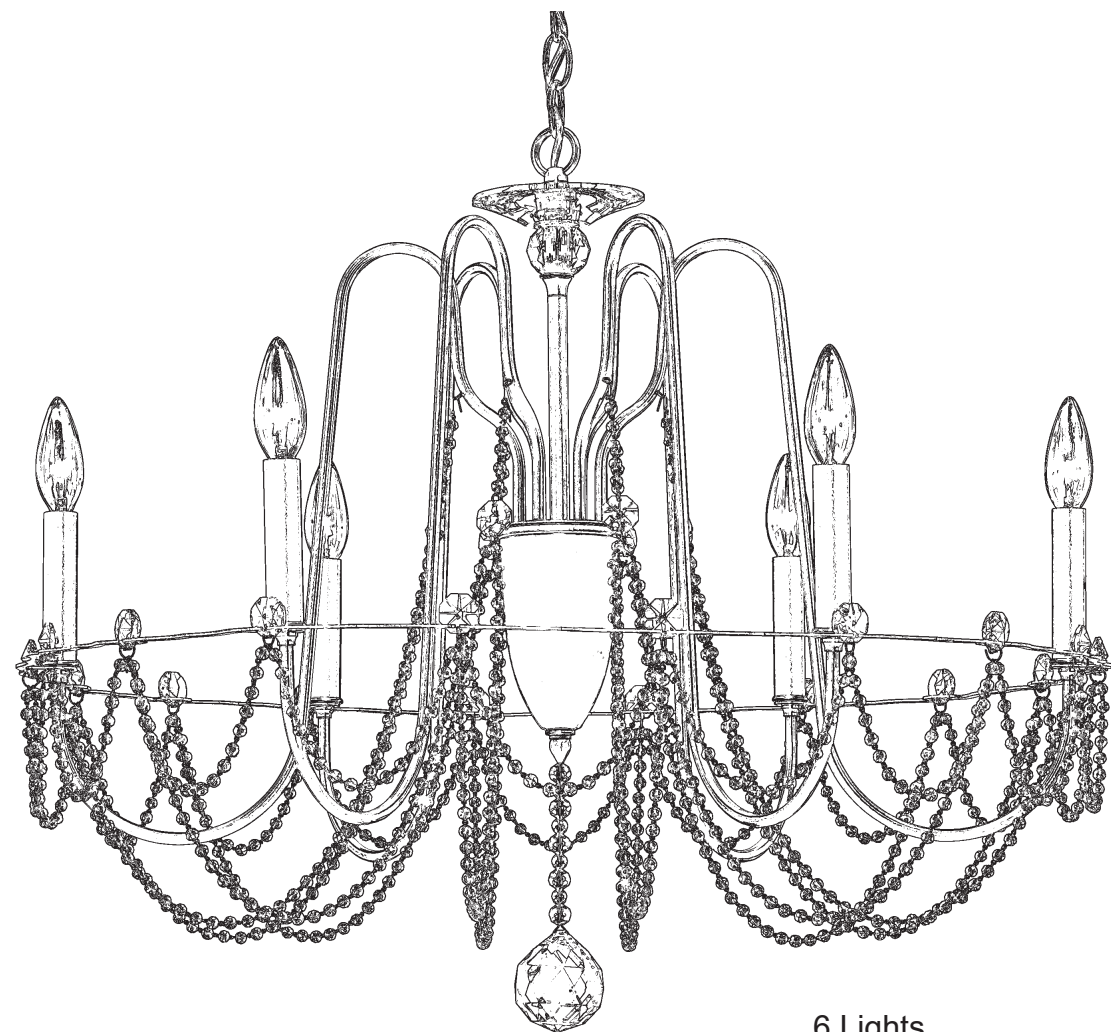











6 Lights  
Diameter: 28"  
Height: 24"  
Hanging Weight: 10lbs.

**T**HIS DESIGN IS THE PROPRIETARY  
TRADE DRESS/TRADEMARK OF  
W SCHONBEK LLC.

 **SCHONBEK** | 1870

 **SCHONBEK** | 1870

								
MAX 60 W	110-120 V							

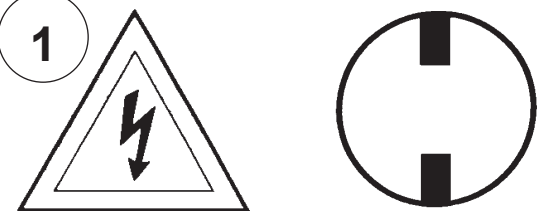

**WARNING:**

1 

**Electrical Danger Turn Power Off**

All electrical components must be installed by a licensed electrician in accordance with the National Electric Code and the appropriate local electrical codes.

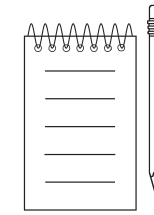
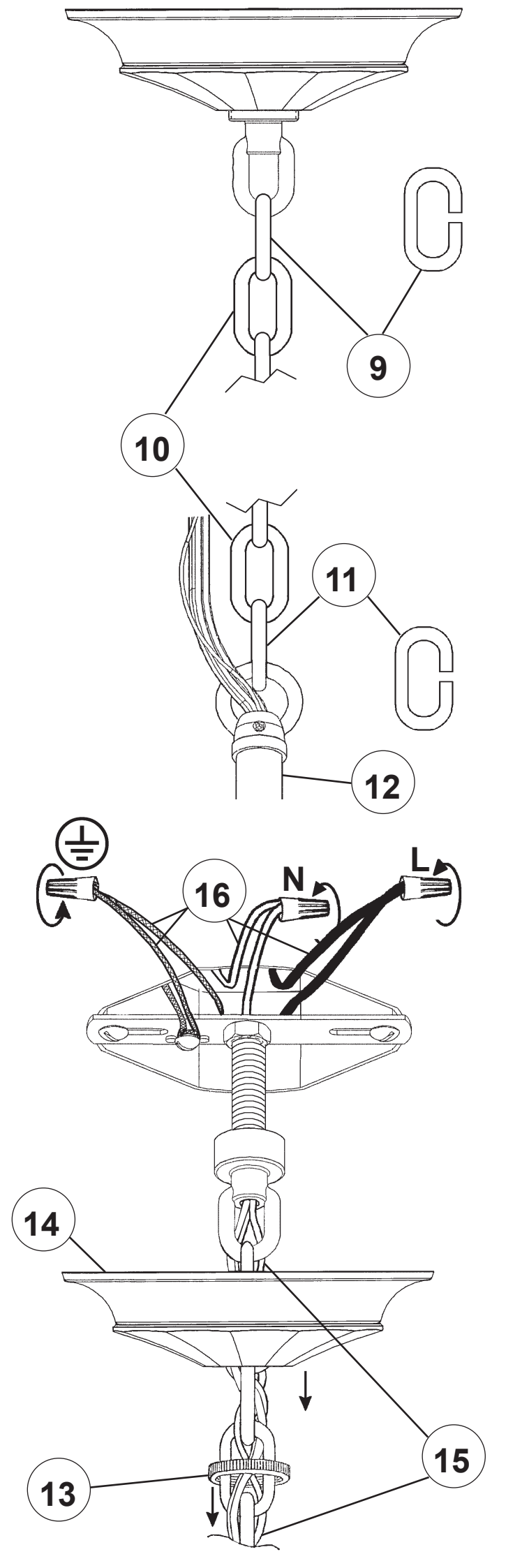
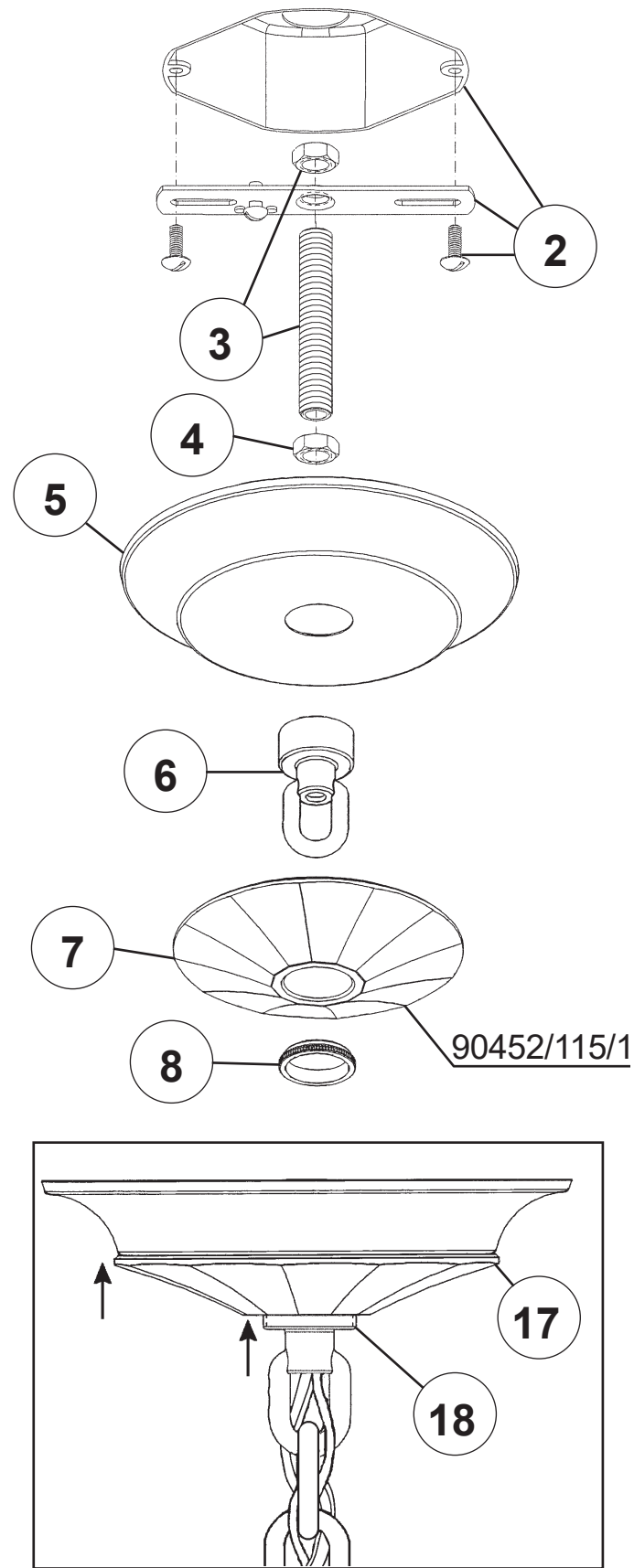

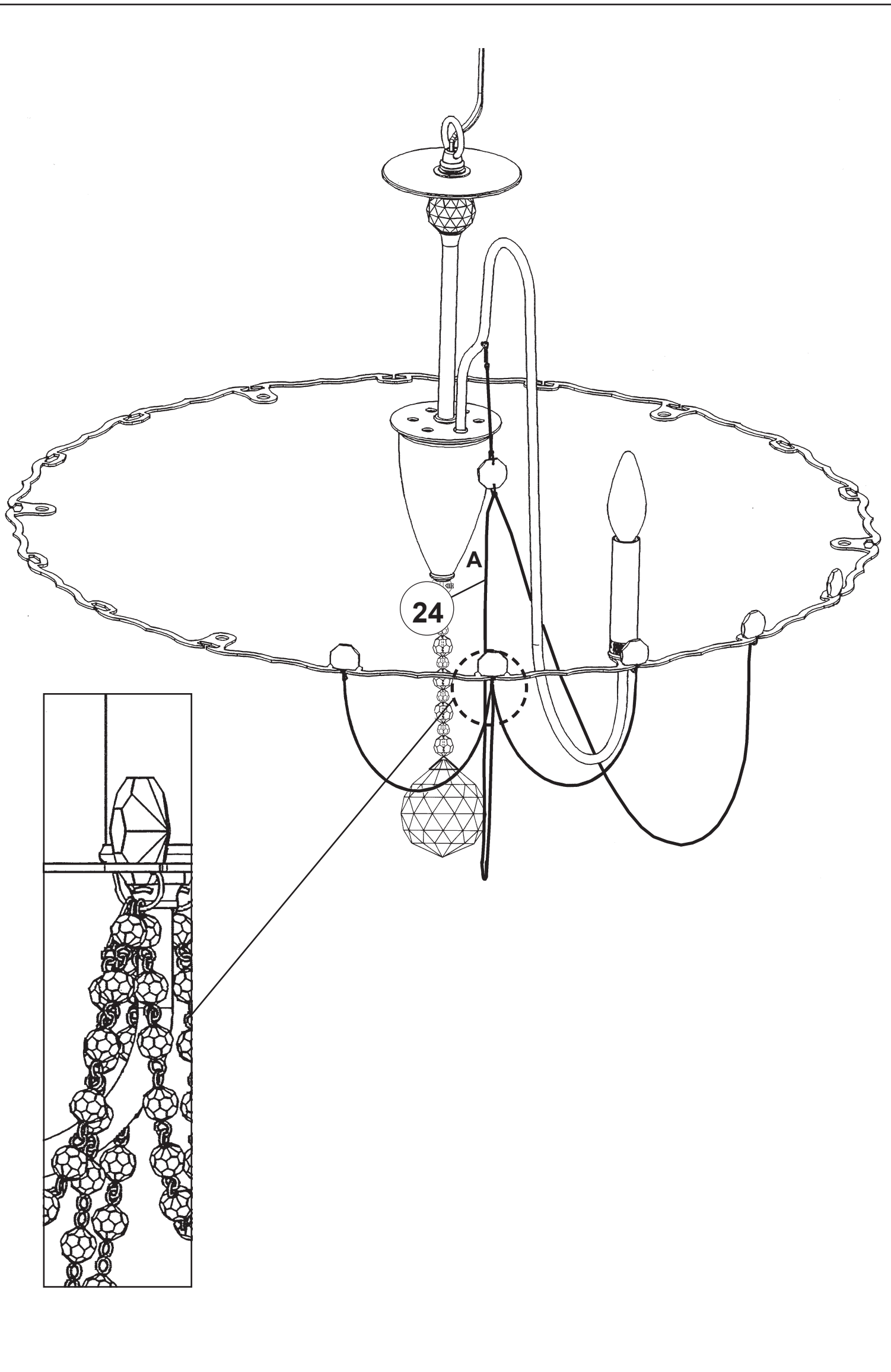

19

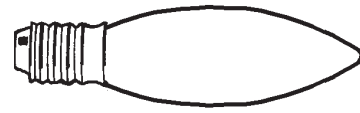

You will need 6 - B10  
25 Watts Recommended  
60 Watts Max

**Install bulbs and be sure  
to test fixture BEFORE  
trimming.**

90452/115

90016/40

