



ASSEMBLING & INSTALLATION INSTRUCTIONS

The drawing shown may not exactly match the product enclosed.
However, the installation instructions do apply to this product.

49145 53165 60255

- ◆ **WARNING! SHUT POWER OFF AT FUSE OR CIRCUIT BREAKER.**
- ◆ **ATTENTION! COUPER LE COURANT AU FUSIBLE OU UN DISJONCTEUR.**

ASSEMBLING THE FIXTURE (Fig.1)

1. Shut off the power at the circuit breaker box. Remove old fixture and all hardware from junction box.
2. Carefully unpack your new fixture and lay out all the parts on a clear area. Take care not to lose any small parts necessary for installation.
3. Slide the lamp holder(I) electrical wires through the shade(G) center hole, tubes(D)/(C)/(B) and canopy(A).
4. Raise all the parts to the pipe thread in order, then by turning it clockwise until tight. Attach the shade(F) onto the shade(G), aligning the top screws, lock it securely with the nuts(E).
5. Attach the mounting screw part way into the side hole of the single bar, then lock it securely with hex nut. Attach the single bar to the junction box using two box screws as shown. The side of the single bar marked "GND" must face out. **The junction box is not included.**
6. While holding the fixture lamp towards the ceiling, connect the electrical wires as Shown in **Fig.2**, making sure that all wire nuts are secured. You may have to wrap the connections with electrical tape. If your outlet has a ground wire (green or bare copper), connect the fixture ground wire to it. Otherwise connect fixture's ground wire directly to the Single bar with the green screw provided. After wires are connected, tuck them carefully inside the junction box.
7. Raise the canopy (A) on to the junction box, aligning screws on single bar with mounting holes in canopy and lock it securely with the column nuts.
8. Install the light bulbs(Not included) in accordance with the fixture specifications. **NOTE: DO NOT EXCEED THE SPECIFIED WATTAGE!**
9. Holding the top chain of the shade(H), hooked to the inside small ring of the shade(G).

Your installation is now complete. Return power to the junction box and test the fixture.

FIG.1

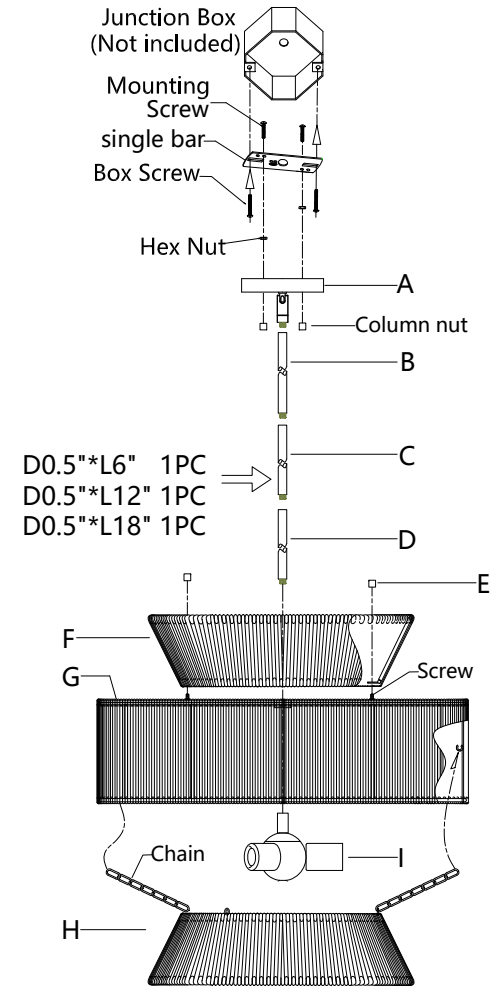
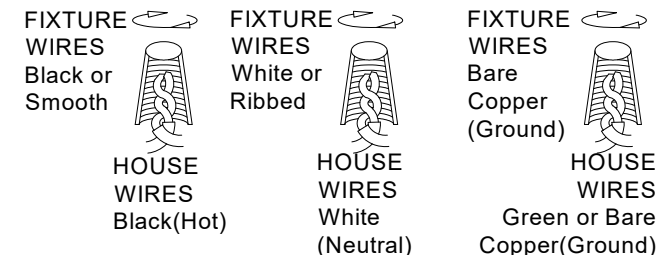

FIG.2



Thank you for purchasing a **LIVEX** product.
 Need assistance with parts or assembly? Please call customer service at: **800-761-8056**
 Or visit us on-line at: WWW.LIVEXLIGHTING.COM