



ASSEMBLING & INSTALLATION INSTRUCTIONS

The drawing shown may not exactly match the product enclosed.
However, the installation instructions do apply to this product.

20597

- ◆ **WARNING! SHUT POWER OFF AT FUSE OR CIRCUIT BREAKER.**
- ◆ **ATTENTION! COUPER LE COURANT AU FUSIBLE OU UN DISJONCTEUR.**

ASSEMBLING THE FIXTURE (Fig.1).

***Shut off the power at the circuit breaker and remove old fixture, including the old small hardware.**

1. Carefully unpack new fixture and lay all the parts on a clear surface. Take care not to lose any small parts necessary for installation.
 2. Raise the shade(C) in to the cone shape shade of fixture body(A), lock it securely with the screws(B).
 3. Screw the pole(D),(E),(F),(G),(H) and base(I) together tightly, **follow wiring instructions carefully (see fig.2).**
 4. Put the assembled lamp onto the concrete base and lock it with the mounting knobs(J).
 - A. The depth of the base will depend on local soil conditions and frost line. The width of the base should be 330mm in order to hold the anchor bolts on it.
 - B. Take the four bolts(L) and run a hex nut(M) fully down each part of the threaded section. Insert the bolt(L) to the template(K) and secure with the second hex nuts.
 - C. Mix and pour the concrete into the former until it reaches the top. Push the assembly into concrete until the plate are 0.25 inches above concrete. Leaving 2 inches of the thread above the concrete.
 - D. It is important to level the template before the concrete sets.
5. Secure the poles using the machine screws(N) on side.
 6. Install the light bulbs(not included) in accordance with the fixture specifications.

NOTE: DO NOT EXCEED THE SPECIFIED WATTAGE!

CONNECTING THE WIRES (Fig.2)

***Feed the fixture wires through the pole(D),(E),(F),(G),(H) and base(I).**

1. Take the black wire(hot) from the outlet box and the black wire of fixture and twist bare ends together. Twist wire connector onto end of wire until snug.
2. Repeat same process with white wire(neutral) from outlet box and white wire of fixture. NOTE: Twist wires together in the same direction you twist the wire connector onto wires.
3. If your outlet box has a grounding wire (green or bare copper), attach this wire and the bare copper wire from the fixture together as step 1. If junction box has no ground wire, attach the fixture bare copper wire to the base(I) bare copper wire.
4. Tuck the wire connections neatly into the pole. Take the fixture body(A) mount onto the pole(D), secure it using the machine screws(N) on side.

Your installation is now complete. Return power to the junction box and test the fixture.

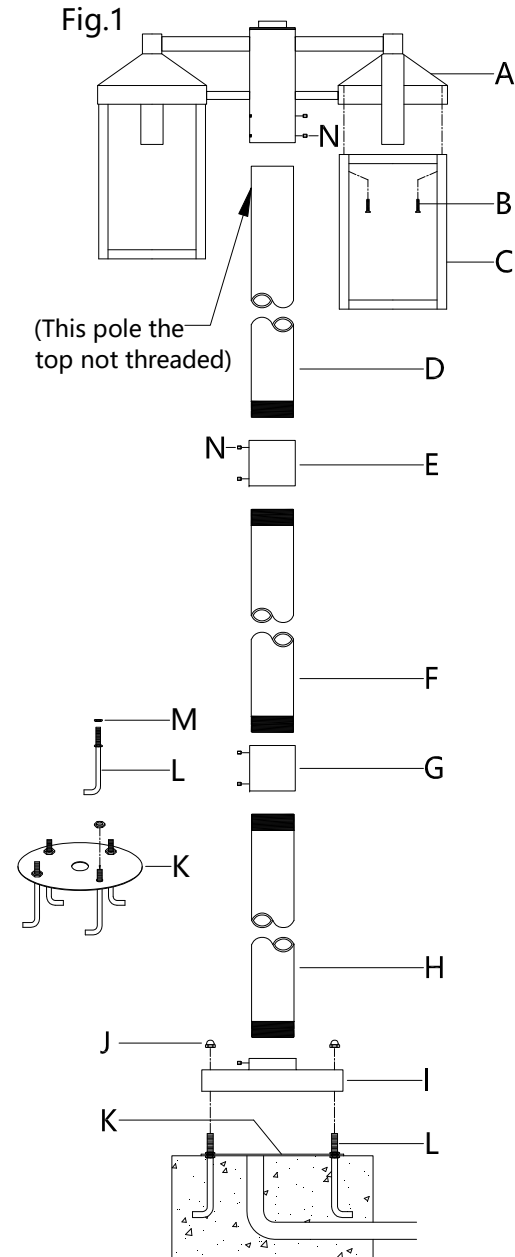





Fig.2

FIXTURE WIRES
Black
or
Smooth





HOUSE WIRES
Black(Hot)

FIXTURE WIRES
White
or
Ribbed



HOUSE WIRES
White
(Neutral)

FIXTURE WIRES
Bare
Copper
(Ground)



HOUSE WIRES
Green or Bare
Copper(Ground)

Thank you for purchasing a **LIVEX** product.

Need assistance with parts or assembly? Please call customer service at: **800-761-8056**

Or visit us on-line at: WWW.LIVEXLIGHTING.COM