

CRYSTORAMA

LIGHTING THE WAY FOR SIXTY YEARS



Crystorama.com

ASSEMBLY INSTRUCTION MODEL # LOT-711-PN

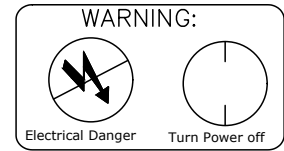

All electrical components must be installed by a licensed electrician in accordance with the National Electric Code and the appropriate local electrical codes.



You will need 1 - Cand.Bulb
40 Watts Recommended 60 Watts Max
USE LED BULBS FOR EXTENDED USE

THIS FIXTURE IS DAMP RATED

How to Install

1. Remove the mounting plate from the backplate and install the mounting plate onto the outlet box using the two outlet box screws.
2. Place the backplate over the mounting plate and secure with the screws.
3. Unscrew the candle sleeve from the socket and put the glass shade over the socket.
4. Install the candle sleeve to the socket and secure the glass shade.
5. Install the bulb onto the socket.

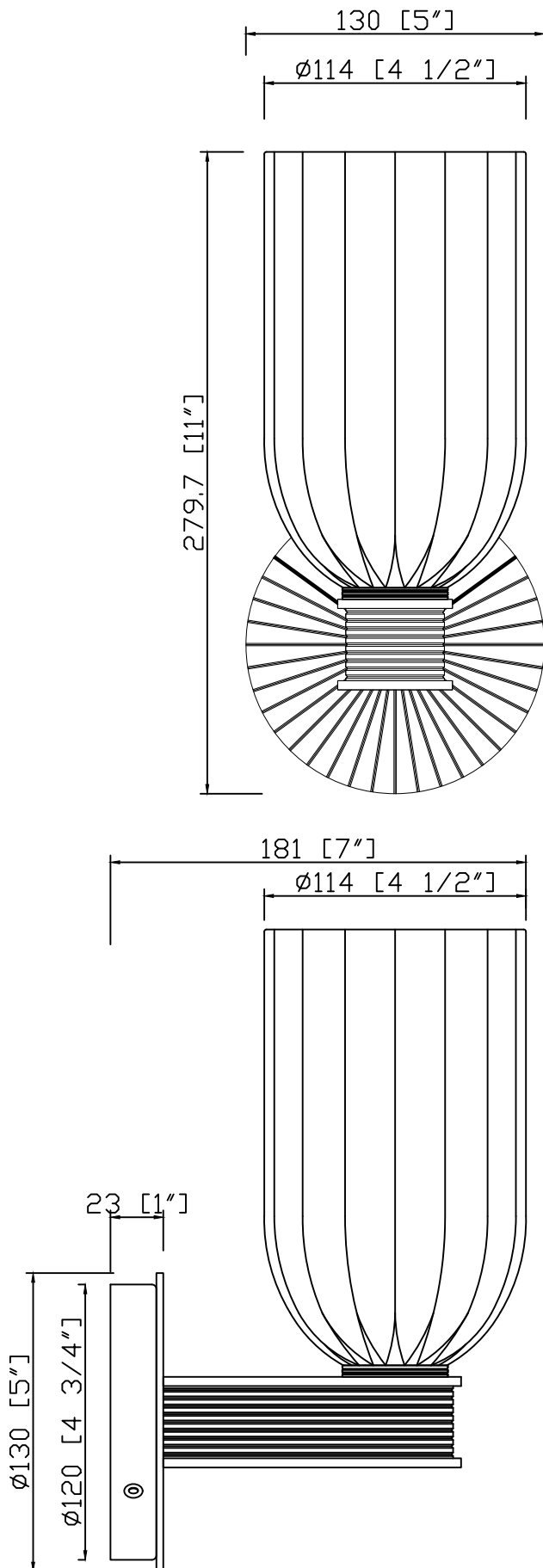

WARNING: This product can expose you to Lead, which is known to the State of California to cause cancer and/or birth defects or reproductive harm. For more information go to www.P65Warnings.ca.gov

CRYSTORAMA

LIGHTING THE WAY FOR SIXTY YEARS



Crystorama.com

ASSEMBLY INSTRUCTION MODEL # LOT-711-PN

Part Number

Part Numbers

- A. (1)-Mounting hardware
- B. (3)-screws
- C. (1)-Back plate (XAR701PNBKP5IN)
- D. (1)-Fixture arm
- E. (1)-Glass (XAR711GLA7.5IN)
- F. (1)-Candle sleeve(XAR701PNCDL2.25IN)
- G. (1)-Bulb

