

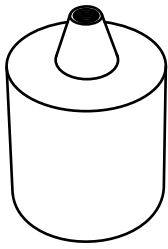

ITEM NAME / NOM D'ITEM: LIZZA SIDE TABLE
ITEM # / NO. ITEM: 109361

PARTS LIST / LISTE DES PIÈCES

(1)	(2)	(3)
 <p>X1</p>	 <p>X1</p>	 <p>X1</p>

ASSEMBLY INSTRUCTIONS / INSTRUCTIONS D'ASSEMBLAGE

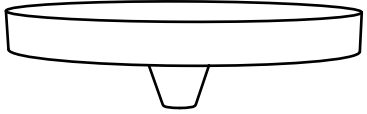
(I)

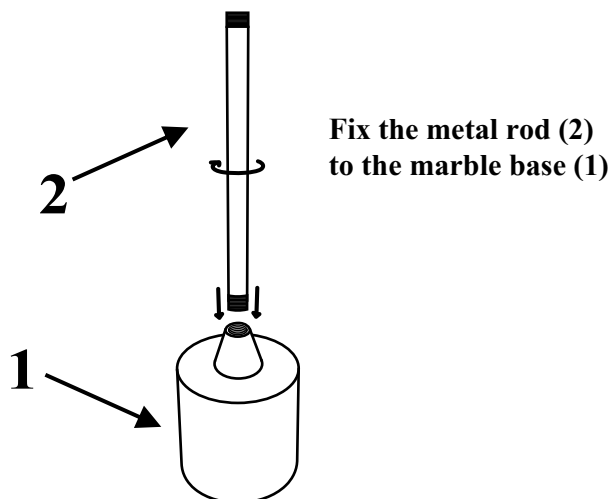

(II)

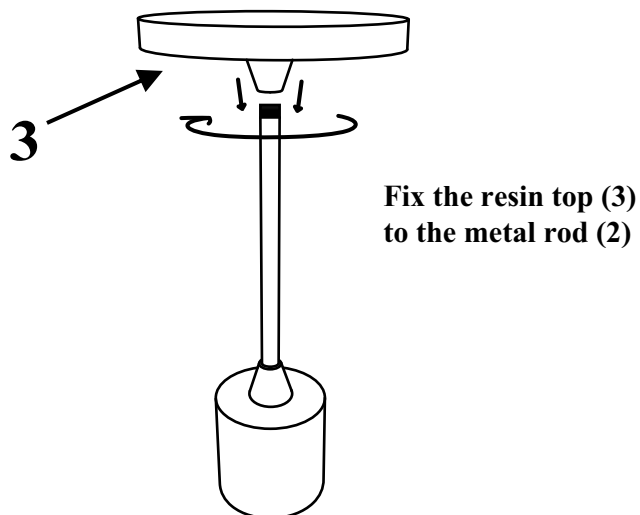

(III)

