

CHD5137

ASSEMBLY & INSTALLATION GUIDE

INSPECT ITEM CAREFULLY BEFORE ATTEMPTING TO INSTALL. IF THERE IS ANY DAMAGE OR OBVIOUS DEFECT, DO NOT INSTALL.

ITEM MAY NOT BE RETURNED ONCE IT HAS BEEN INSTALLED.

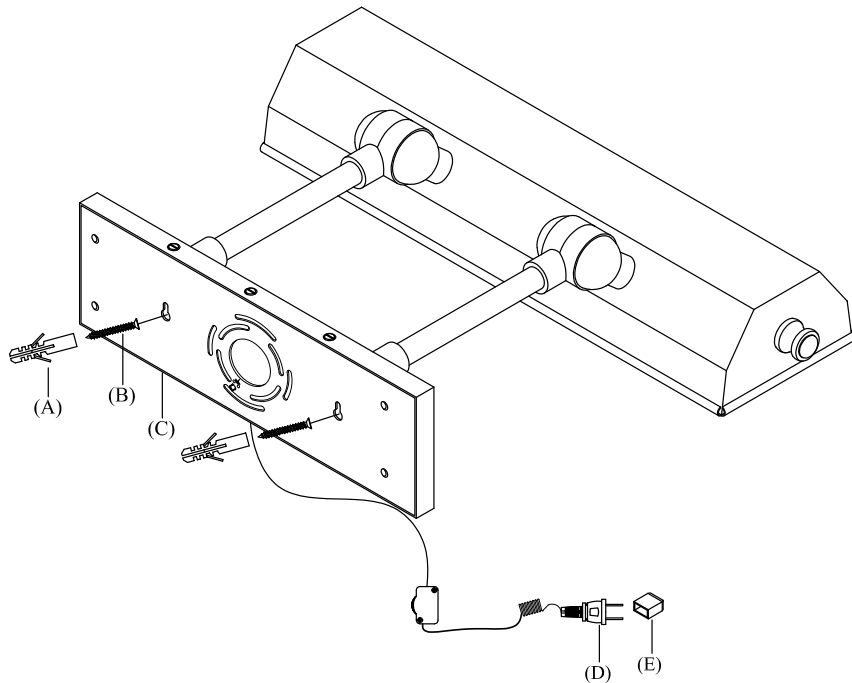

1. Measure a distance of both mounting holes at backside of lamp base (C). Mark two point locations with same distance on the wall, make sure they are horizontally each other.
2. Drill small holes into your marked locations on the wall. The holes should be large enough to accommodate the plastic anchors (A). Push the plastic anchors (A) into the holes in the wall.
3. Insert mounting screws (B) into plastic anchors (A), make sure screw head with 1/8" threads are visible.
4. Hook lamp base (C) onto both screws (B).
5. Insert light bulbs into sockets.
6. Remove plastic cover (E) from electrical plug (D).
7. Plug lamp cord into wall outlet.