

Bespin Large (LED)

700FMBESL_-LED 1.0

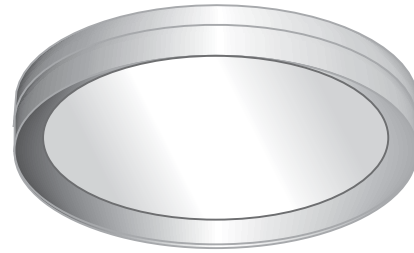

GENERAL PRODUCT INFORMATION:



These fixtures are intended to be installed utilizing NEC compliant junction boxes.

This product is suitable for damp or wet locations.

This product can be dimmed with a low-voltage electronic dimmer.

This fixture may be ceiling or wall mounted.

This instruction shows a typical installation.

CAUTION - RISK OF FIRE
 This product must be installed in accordance with the applicable installation code by a person familiar with the construction and operation of the product and the hazards involved.
 Use minimum 90°C supply conductors.

Install the Fixture

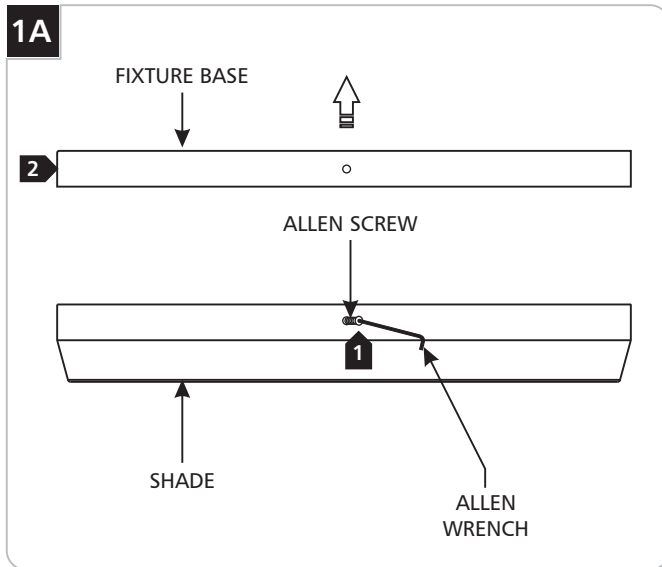

- 1** While supporting the shade, remove the two Allen screws on fixture base with the Allen wrench.
- 2** Remove the fixture base out of the shade.

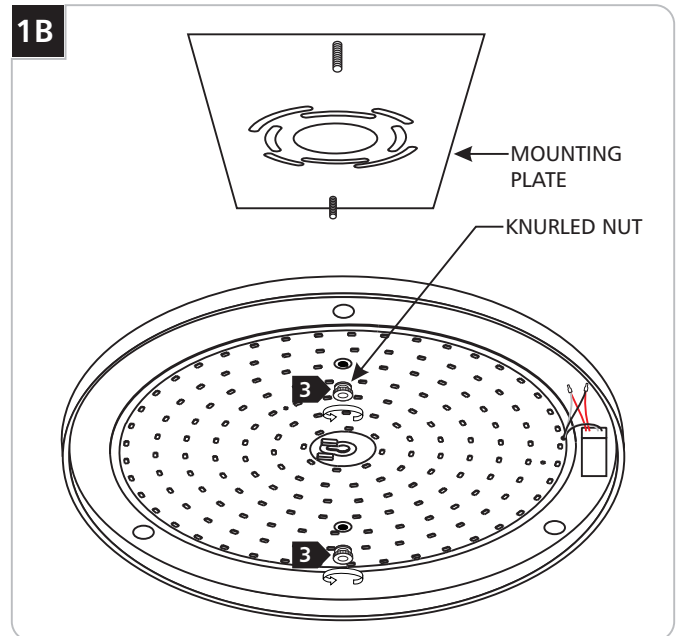

- 3** Remove the mounting plate from the fixture base by unscrewing the two knurled nuts.

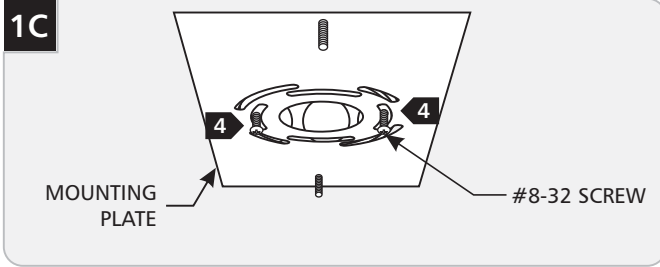

- 4** Secure the mounting plate to the electrical box with 2 #8-32 screws.

NOTE: Install the mounting plate so that the studs are parallel or perpendicular to the walls, this will ensure that the fixture is oriented to the room.

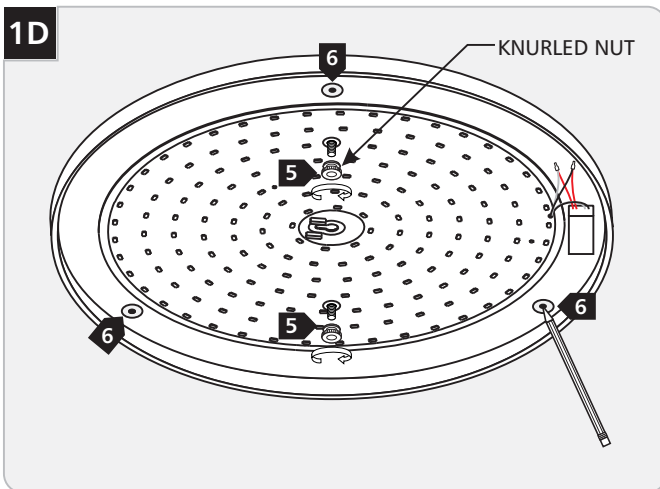

- 5** Temporarily install the fixture base to the electrical box with two knurled nuts.
- 6** Mark the three anchor locations and uninstall the fixture base.

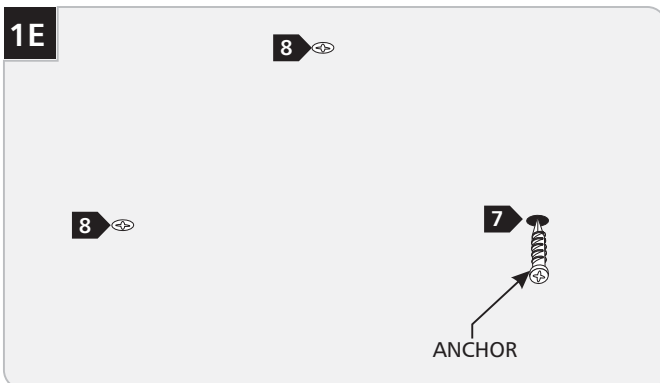

- 7** At the marked location, push the anchor in up to the threads.
- 8** Screw the anchor the rest of the way in with a screwdriver.

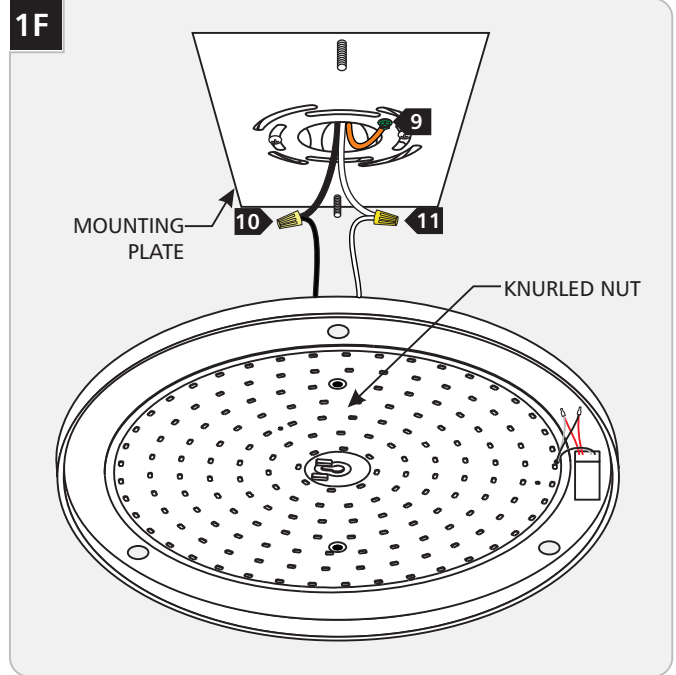

- 9** Connect the fixture to a suitable ground in accordance with local electrical codes.
- 10** Connect the black driver wire to the hot power line wire with a wire nut.
- 11** Connect the white driver wire to the neutral power line wire with a wire nut.

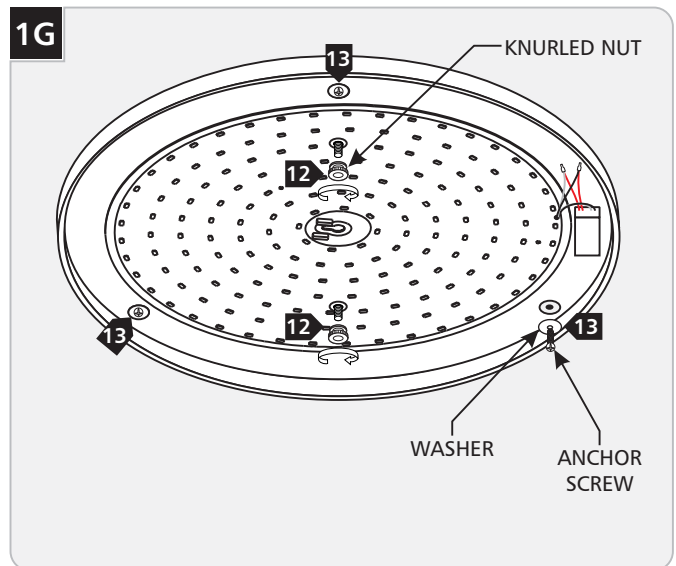

- 12** Mount the fixture base to the ceiling by reinstalling it onto the mounting plate and secure it tightly with the knurled nuts.
- 13** Secure the fixture base to the anchors with the washers and anchor screws.

Install the Shade

2A

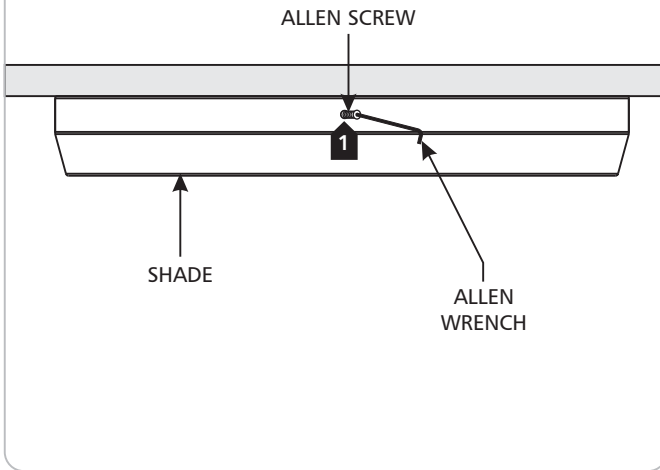

- 1 Align the holes on the shade with the holes on the fixture base and reinstall the two Allen screws using the Allen wrench.

SAVE THESE INSTRUCTIONS!



TECH LIGHTING®

7400 Linder Ave, Skokie, IL 60077

847.410.4400

www.techlighting.com

© 2016 Tech Lighting, L.L.C. All rights reserved. The "Tech Lighting" graphic is a registered trademark of Tech Lighting, L.L.C. Tech Lighting reserves the right to change specifications for product improvements without notification.

A Generation Brands Company