

# ASSEMBLY AND INSTALLATION INSTRUCTIONS

T0225

**WARNING:** TO AVOID RISK OF ELECTRICAL SHOCK, BE SURE TO SHUT OFF POWER BEFORE INSTALLING OR SERVICING THIS FIXTURE.

**NOTES:** 1. Before installing, consult local electrical codes for wiring and grounding requirements.  
2. READ AND SAVE THESE INSTRUCTIONS.

## Hardware Package (included):

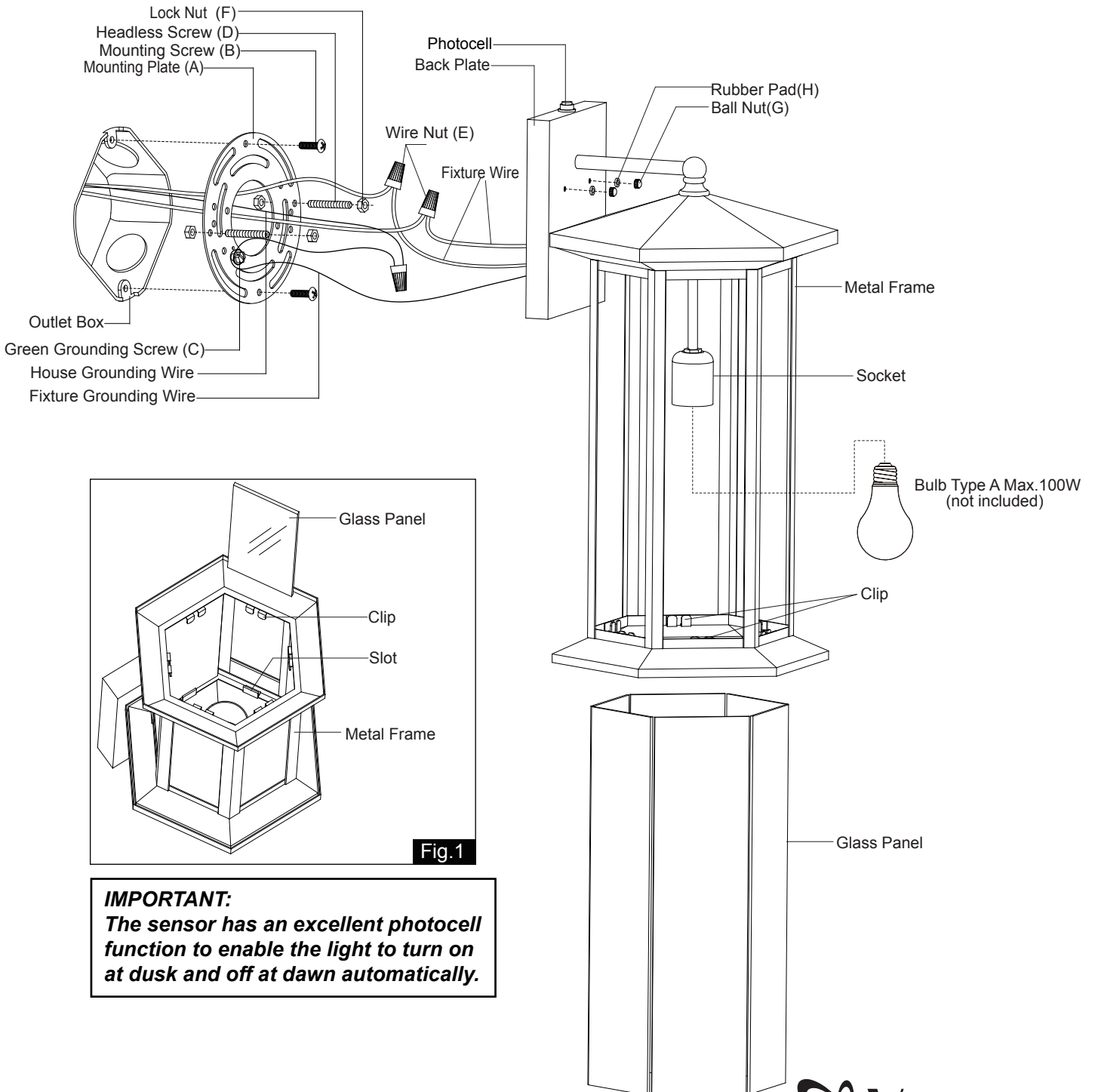
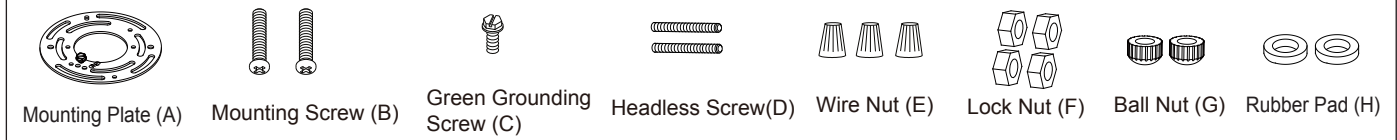

Fig.1

**IMPORTANT:**  
*The sensor has an excellent photocell function to enable the light to turn on at dusk and off at dawn automatically.*

## Installation Steps

Turn off the power at fuse or circuit box

1. Thread two headless screws through the mounting plate, and then secure them with four lock nuts (two on each side of the mounting plate). Adjust the length of the headless screws if necessary.  
Note: Make sure that the headless screws are lined up horizontally to make the fixture level.
2. Attach mounting plate to the outlet box using two mounting screws.
3. Take a glass panel, insert it into the slot at one side of the metal frame carefully, secure it by pressing clips. Repeat with the other glass panels.(See Fig.1)
4. Pull out the source wires from the outlet box. Make wire connections using wire nuts as follows:
  - Connect the hot wire (usually black insulation) from the fixture to the black wire from the power source.
  - Connect the neutral wire (usually white insulation) from the fixture to the white wire from the power source.
  - Attach the fixture grounding wire (usually green insulation or bare wire) to the mounting plate with the green grounding screw, and then connect it to the house grounding wire with the wire nut.Carefully put the wires back into the outlet box.
5. Attach the back plate to the mounting plate by inserting two headless screws, and then secure it with two rubber pads and two ball nuts.  
**NOTE: With silicone caulking compound, caulk completely around where the back plate meets with the wall surface to prevent water from seeping into the outlet box.**
6. Install a bulb (not included). Check relamping label at socket area or packaging for maximum allowed wattage.

Turn on the power at fuse or circuit box



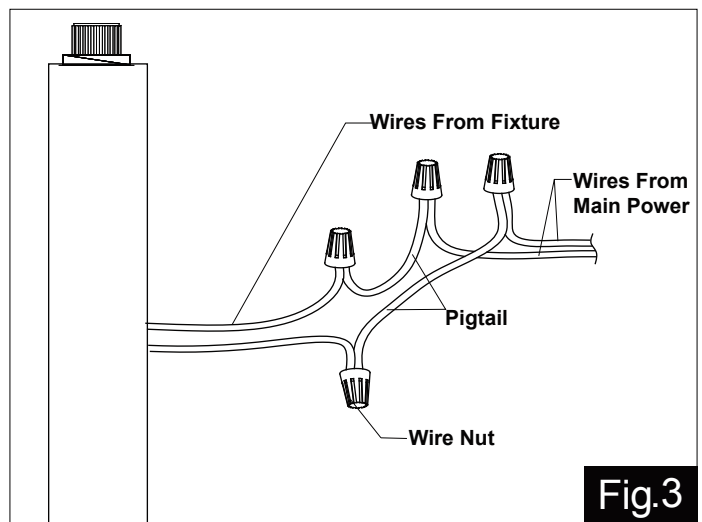
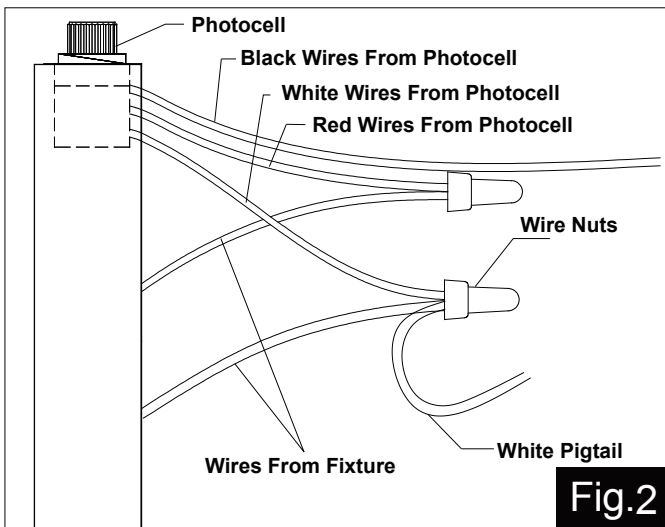





## Operation the Unit Without Photocell



1. Turn off the power at the fuse or circuit box before starting installation.
2. Loosen the wire nuts connected with the wires from photocell. (See Fig.2)  
**Note: Do not move the photocell to prevent water from seeping into the outlet box.**
3. Take a white pigtail and black pigtail and make wire connections using wire nuts: (See Fig.3)
  - a. The black wire from the fixture to one end of the black pigtail.
  - b. The white wire from the fixture to one end of the white pigtail.
  - c. The other end of the black pigtail to the black wire from the power source.
  - d. The other end of the white pigtail to the white wire from the power source.Put all wires back into the back plate of the fixture.

The following parts are available for re-order if damaged or missing.

**Spare Parts List:**

 Mounting Plate (A)	 Mounting Screw (B)	 Green Grounding Screw (C)	 Headless Screw (D)
 Wire Nut (E)	 Lock Nut (F)	 Ball Nut (G)	 Rubber Pad (H)

Assembly Kit 5518MM (1 SET) ←

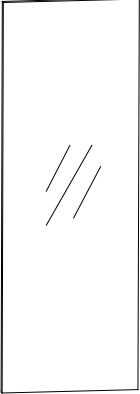
 Glass Panel 9796WL(6PCS)

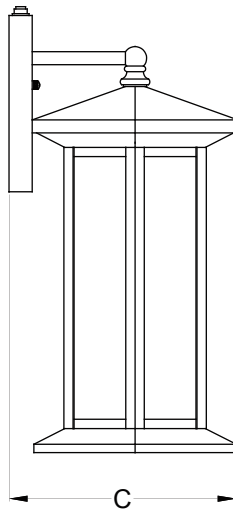
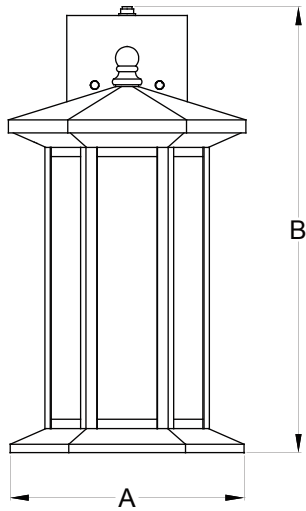

A: 12"    B: 23"    C: 11-3/8"