

Project:

REALS LED Bollard Spec Sheet

SKU: 7304.PC.FW.74-WL Learn more at:
<https://sonnemanlight.com/real-led-bollard>

Description: Bring definition and architectural interest to outdoor sites and along paths or planted beds, with bollards of perfect solid geometry and LED lighting functionality. REALS Bollards offer a broad range of configurations, with many available options for lenses, caps, and heights for a variety of LED illuminating possibilities. Also available as a [Double Bollard](#), [Downlight Scence](#), [Up/Down Scence](#), and [Surface Mount](#).

Type #:

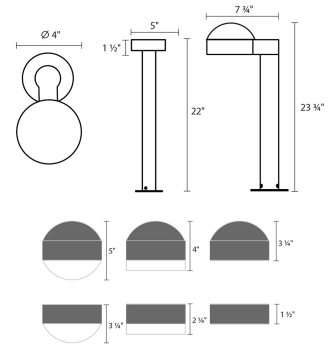

Dimensions

Height:	22"
Width:	5"
Length:	7.75"
Canopy/Backplate/Base:	4"
Size:	22"
Canopy/Backplate/Base Height:	0.25

Electrical Specs

Bulb(s) Included?:	Yes
Bulb 1 Type:	Integral LED
Bulb Quantity:	1
Input Voltage:	12VAC
Wattage:	10
Initial Lumens:	1040
Color Temperature:	3000K
CRI:	90
Power Supply Type:	Transformer
Power Supply Location:	Remote (Sold Separately)
Dimming Type:	Non-dimmable
Bulb Max Wattage:	10

Installation

Installation:	Licensed electrician required
---------------	-------------------------------

Shipping

Carton 1 L x W x H:	29" X 12" X 9"
Carton 1 Gross Weight:	8 LBS
Fixture Weight:	6

Shade

Lens Type:	Plate Cap and White Cylinder Lens
Shade 1 Material:	Frosted White Polycarbonate

Available Finishes

Available Finishes: Textured Bronze (.72), Textured Gray (.74)

General Listings

Features:	Wet Rated
Certification:	C-ETL-US
Color/Finish:	Textured Gray (.74)
Dark Sky Friendly:	N