

# SimplyShade™

## **Add-On Weight**

*30 lbs. Base Weight*

SSBW30

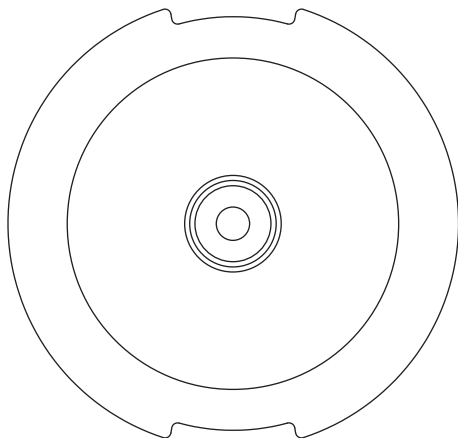

Instruction Manual

Thank you for your purchase of SimplyShade's 30 lbs. Add-On Weight.

Please remove all contents from the package, inspect and review checklist.

### SSBW30 CHECKLIST

A - Add-On Weight

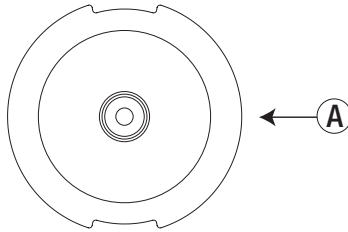

#### Step 1

Tilt base back to its side (Fig. 1). Attach add-on weight by inserting the add-on weight into the center threads of the base (Fig. 2) and turn clockwise  (Fig. 3) until fully tightened (Fig. 4). Turn base upright. Your base is ready for use.

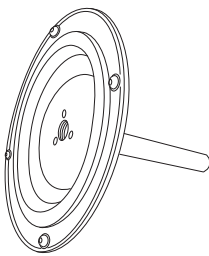

(Fig. 1)

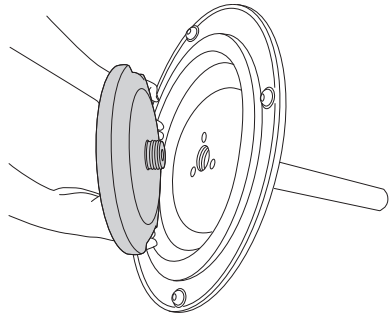

(Fig. 2)

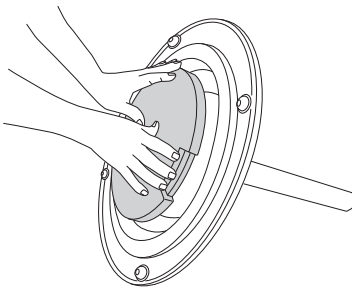

(Fig. 3)

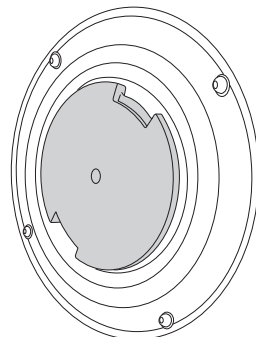

(Fig. 4)

## Dimensions

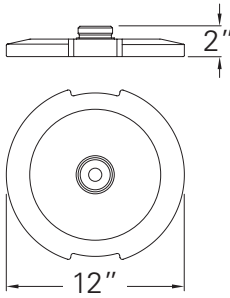

### WARRANTY:

The manufacturer warrants that this umbrella, when subject to normal and proper use, will be free from manufacturing defects for a period of one year from the original date of purchase. Should any defect occur during the specified time period, the manufacturer will repair, replace, or provide replacement parts, at its own option. Limited warranty against fabric fading, based on fabric grade. Warranty is not transferable.

We will not warrant any claim coverage unless both the original sales receipt and request form are sent to us. Any items that are returned for warranty or non warranty purposes must be issued a Return Authorization Number. Only

upon issuance of an RA# and inspection by our QC department will credit or replacement of umbrella be issued. It is the customer's responsibility to pay the freight on return products or replacement parts. ALL RETURNED ITEMS MUST INCLUDE THE RA# CLEARLY WRITTEN ON THE RETURN PACKAGE or package will be refused by our warehouse personnel.

NOTE: Damages and failure caused by improper use due to neglect of reasonable and necessary care are not covered by this warranty.

Additionally, acts of nature (including but not limited to wind, hurricanes, tomadoes, and storms) are not covered by this warranty.

### CAUTION: HANDLE WITH CARE

- To reduce personal injury and damage, read and follow this Assembly and Operation information.
- Close the umbrella in windy conditions or when a storm approaches. Never allow the umbrella to flap in the wind; this could damage the canopy.
- Do not leave open umbrella unattended.
- Do not allow children to play on or with the base.

SimplyShade

[www.simplyshade.com](http://www.simplyshade.com)

©2015 SimplyShade - All Rights Reserved.

7/15