

SimplyShade™

Bermuda *Base Weights*

SSBSPB

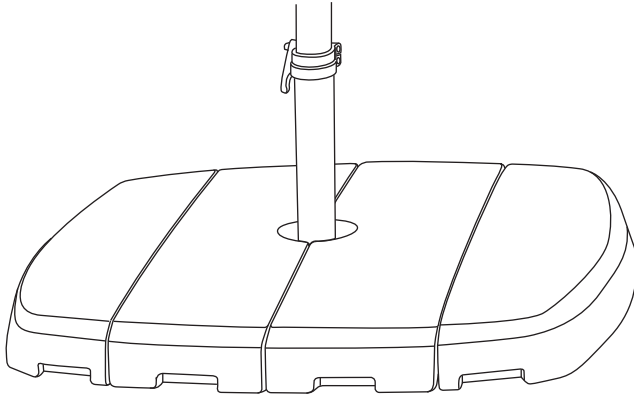

Instruction Manual

Thank you for your purchase of SimplyShade's Bermuda Base Weights.

Please remove all contents from the package, inspect and review checklist.

CHECKLIST

A - (4) Resin base weights included

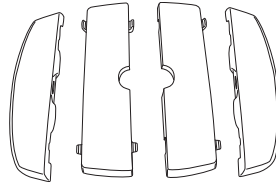

Prior to Assembly

Select area to set Cross Base Stand and place in desired location. *Moving the umbrella will be difficult once fully assembled.* Be sure bottom pole stem is attached to cross bar stand and cross bars are adjusted to 20" position.

Step 1

Remove 4 resin base weights from carton and lay on soft surface (Fig. 1). Remove caps from each resin base weight by turning counter clockwise (Fig. 2) and fill with dry playground sand (Fig. 3). Each resin base weight holds up to 55 lbs. of sand, 220lbs for all 4.

NOTE: When filling the containers, it is necessary to wet down the sand after partial filling. After wet down, fill each resin base weight with remaining sand. Place cap back onto cross bar weight and turn clockwise.

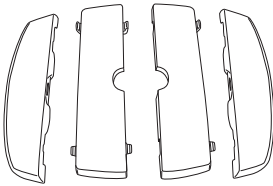

(Fig. 1)



(Fig. 2)

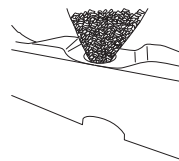

(Fig. 3)

Step 2

Place each resin base weight onto Cross Bar Stand. Hook each section together so the resin base weights are secured in place (Fig. 4). Begin with middle sections first and work your way out (Fig. 5).

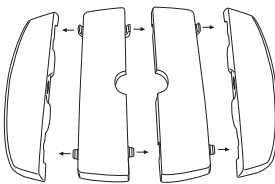

(Fig. 4)

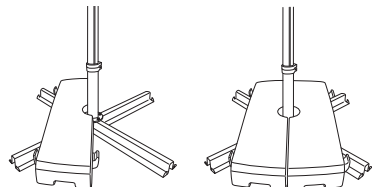

(Fig. 5)

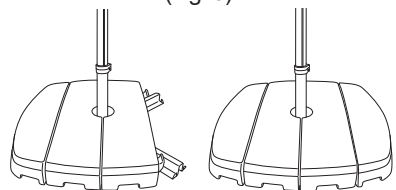

WARRANTY:

The manufacturer warrants that this umbrella, when subject to normal and proper use, will be free from manufacturing defects for a period of one year from the original date of purchase. Should any defect occur during the specified time period, the manufacturer will repair, replace, or provide replacement parts, at its own option. Limited warranty against fabric fading, based on fabric grade. Warranty is not transferable.

We will not warrant any claim coverage unless both the original sales receipt and request form are sent to us. Any items that are returned for warranty or non warranty purposes must be issued a Return Authorization Number. Only

upon issuance of an RA # and inspection by our QC department will credit or replacement of umbrella be issued. It is the customer's responsibility to pay the freight on return products or replacement parts. **ALL RETURNED ITEMS MUST INCLUDE THE RA# CLEARLY WRITTEN ON THE RETURN PACKAGE** or package will be refused by our warehouse personnel.

NOTE: Damages and failure caused by improper use due to neglect of reasonable and necessary care are not covered by this warranty.

Additionally, acts of nature (including but not limited to wind, hurricanes, tornadoes, and storms) are not covered by this warranty.

IMPORTANT: HANDLE WITH CARE

- Fully assembled, the umbrella weighs *approximately* 290 lbs. with resin base weights. Moving the umbrella fully assembled will increase the risk of damage to your umbrella and/or cause serious injury. *We recommend a two-person team for assembly and disassembly.*
- Cross Bar Stand will not support umbrella without proper weight. Using the cross bar stand without weight will damage your umbrella and may cause injury.

DO NOT OPEN UMBRELLA UNTIL WEIGHTS ARE SECURED.

- Do not allow children to play on or with the base.
- Close the umbrella in windy conditions or when a storm approaches.
- No umbrella should be left unattended in the open position.

SimplyShade

www.simplyshade.com

©2015 SimplyShade - All Rights Reserved.

7/15