

 **SCHONBEK** | 1870

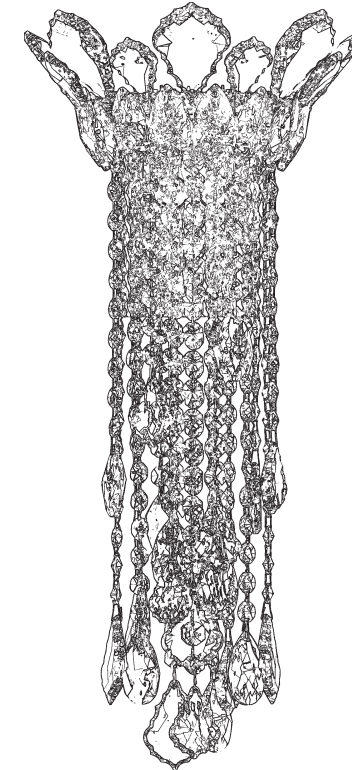







**TRILLIANE STRANDS**  
**TR0833N- \_\_ \_\_ H**



**T**HIS DESIGN IS THE PROPRIETARY  
TRADE DRESS/TRADEMARK OF  
W SCHONBEK LLC.

2 Lights  
Length: 10"  
Height: 21"  
Extension: 7-1/2"  
Hanging Weight: 6lbs.

 **SCHONBEK** | 1870

			<b>S</b>					
MAX <b>40</b> W	110-120 V							

2 X  : G9 40W MAX 

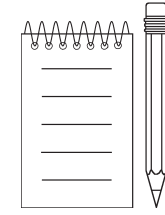
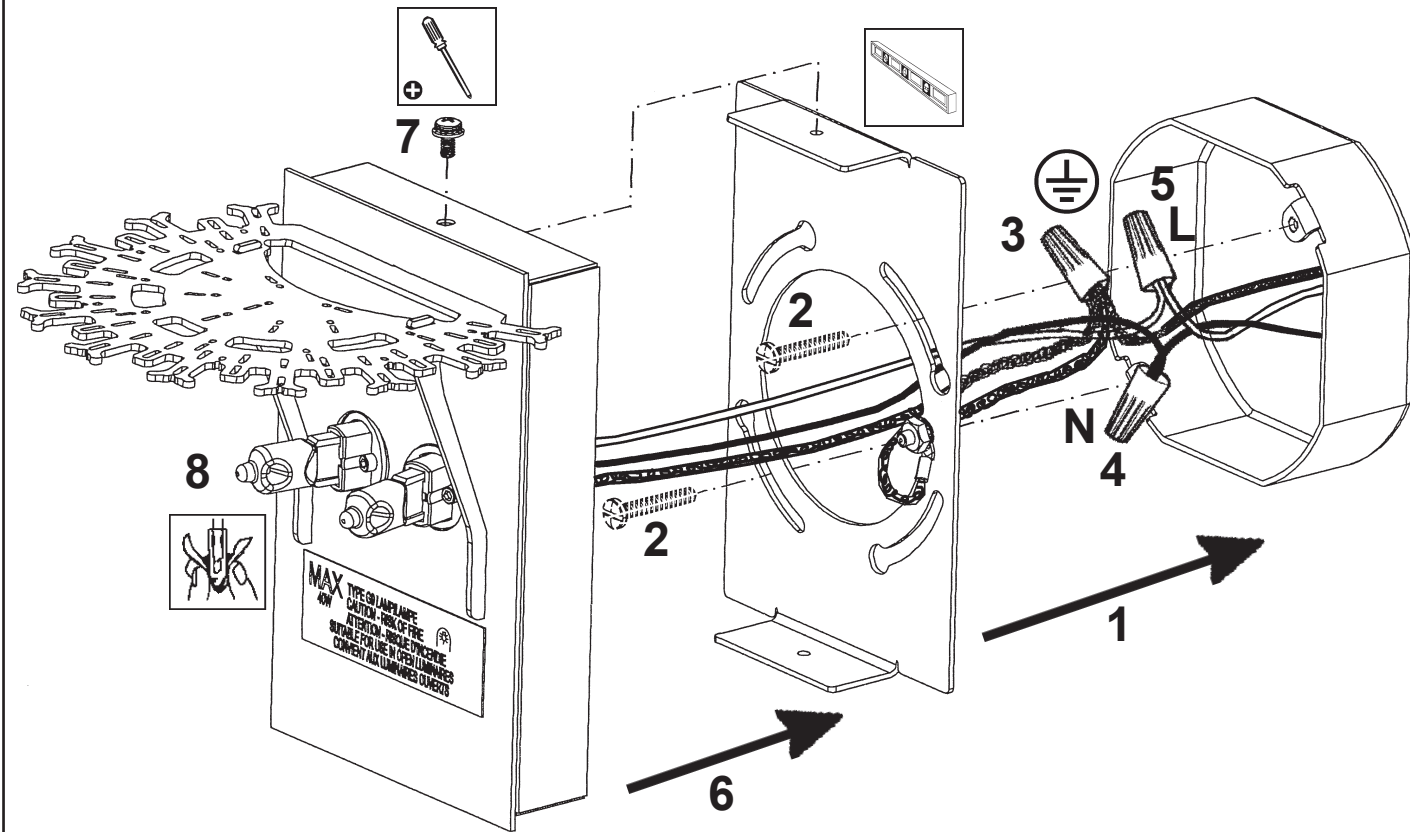

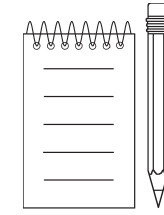
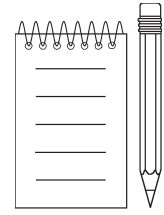

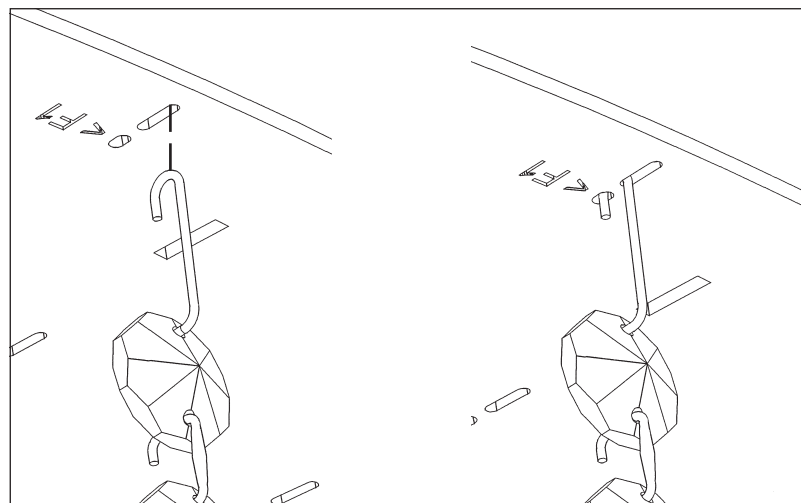
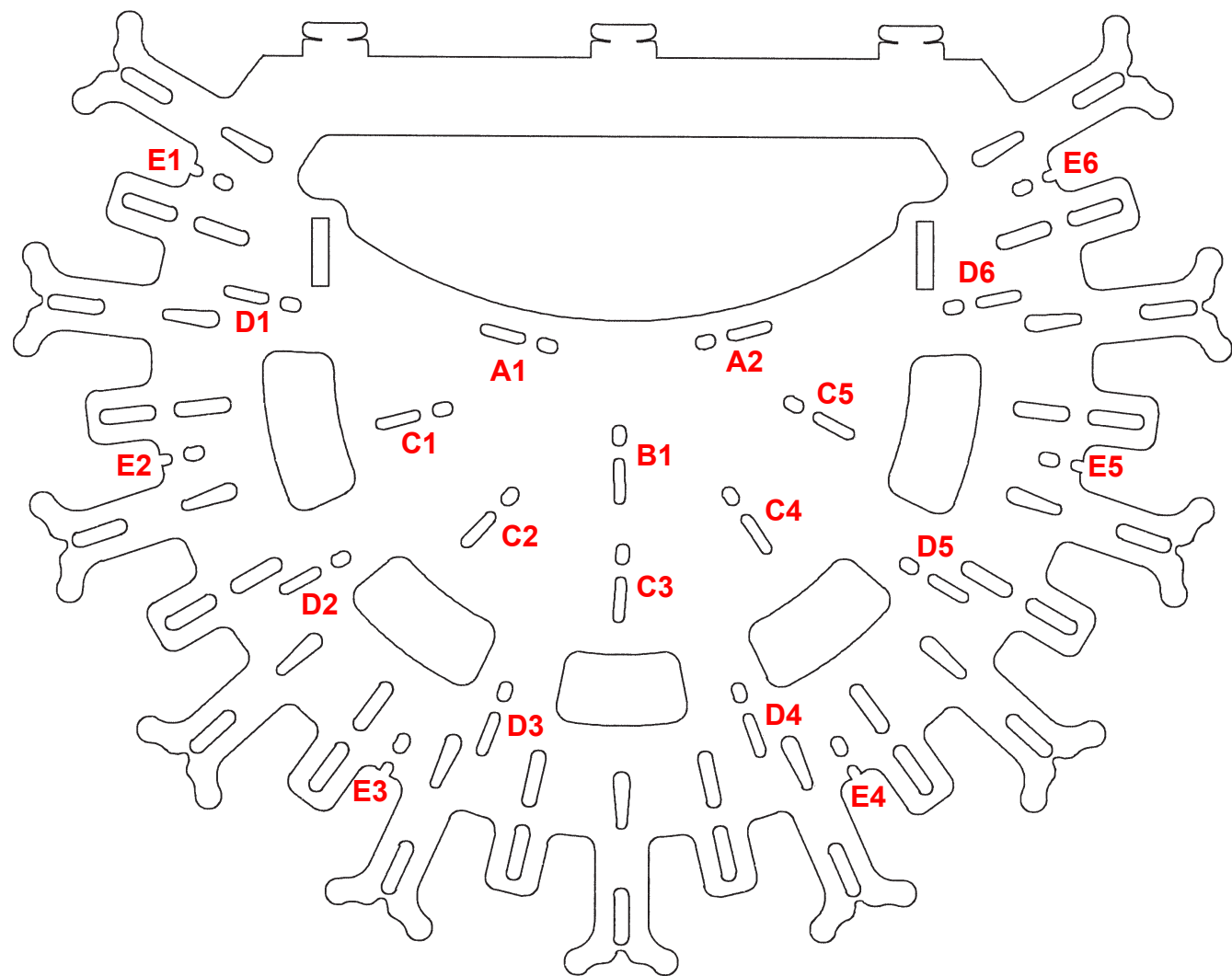

- 9** A1 - A2
- 10** B1
- 11** C1 - C5
- 12** D1 - D6
- 13** E1 - E6

After hanging all trim, remove labels from crystals. If residue remains, wipe off crystal with a soft, dry cloth.

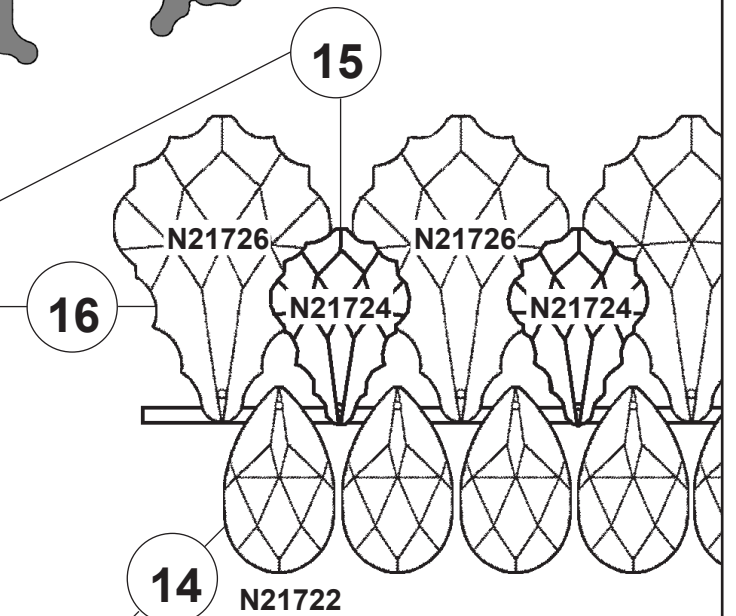
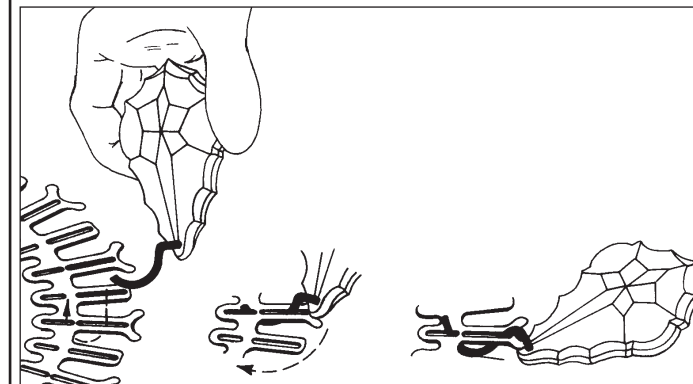
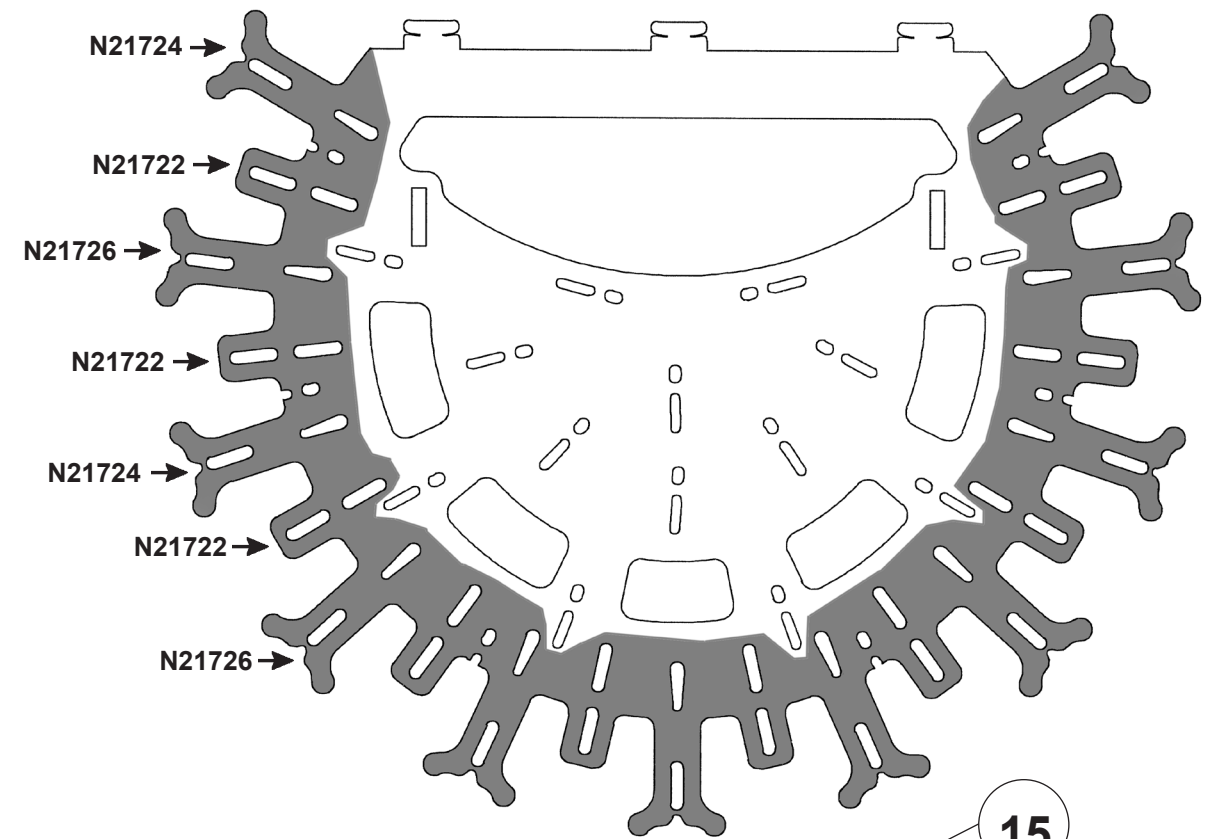

 **SCHONBEK** | 1870



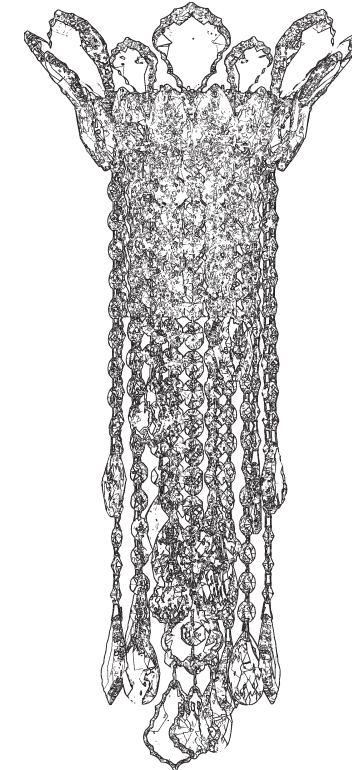





**TRILLIANE STRANDS**  
**TR0833N- \_\_ \_ R**



**T**HIS DESIGN IS THE PROPRIETARY  
TRADE DRESS/TRADEMARK OF  
W SCHONBEK LLC.

2 Lights  
Length: 10"  
Height: 21"  
Extension: 7-1/2"  
Hanging Weight: 6lbs.

 **SCHONBEK** | 1870

			<b>S</b>					
MAX <b>40</b> W	110-120 V							

2 X  : G9 40W MAX 

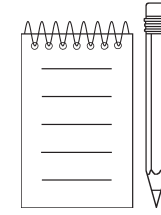
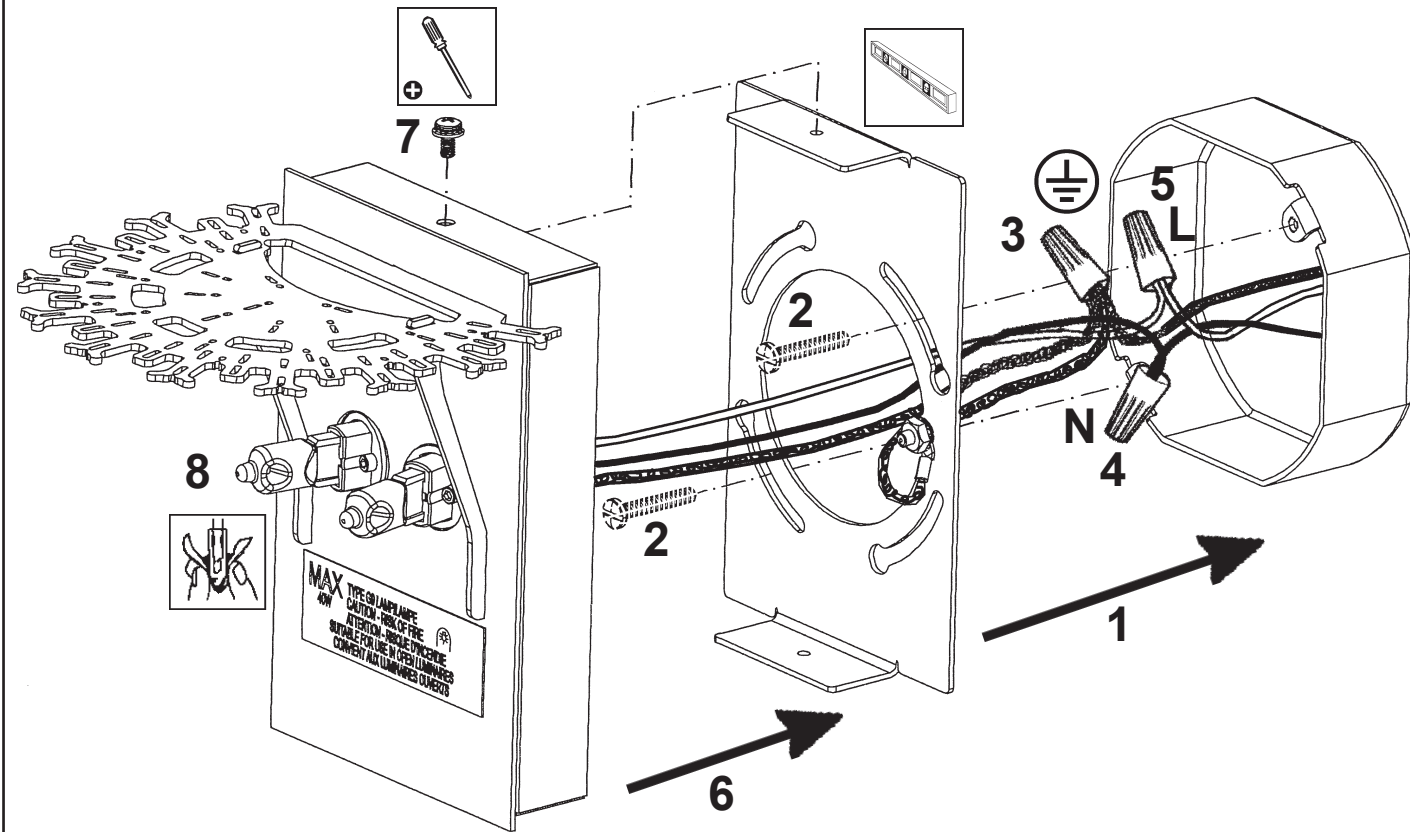

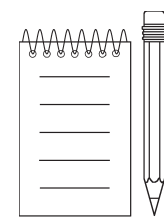
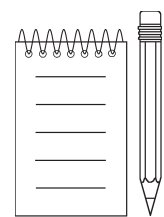



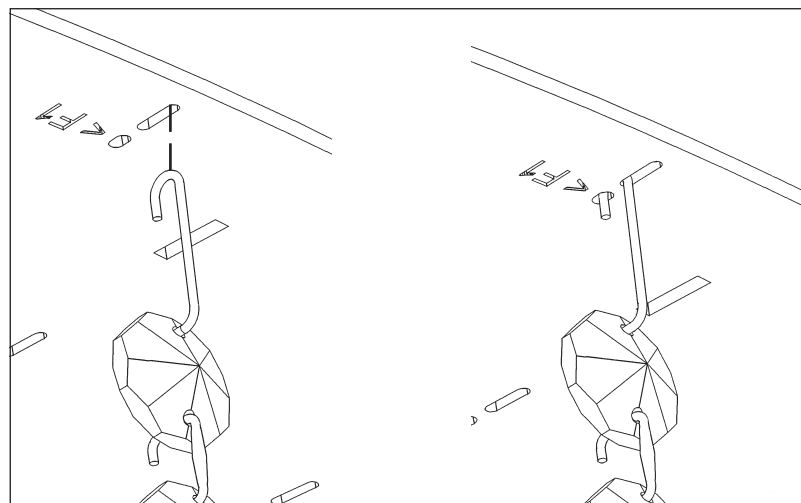
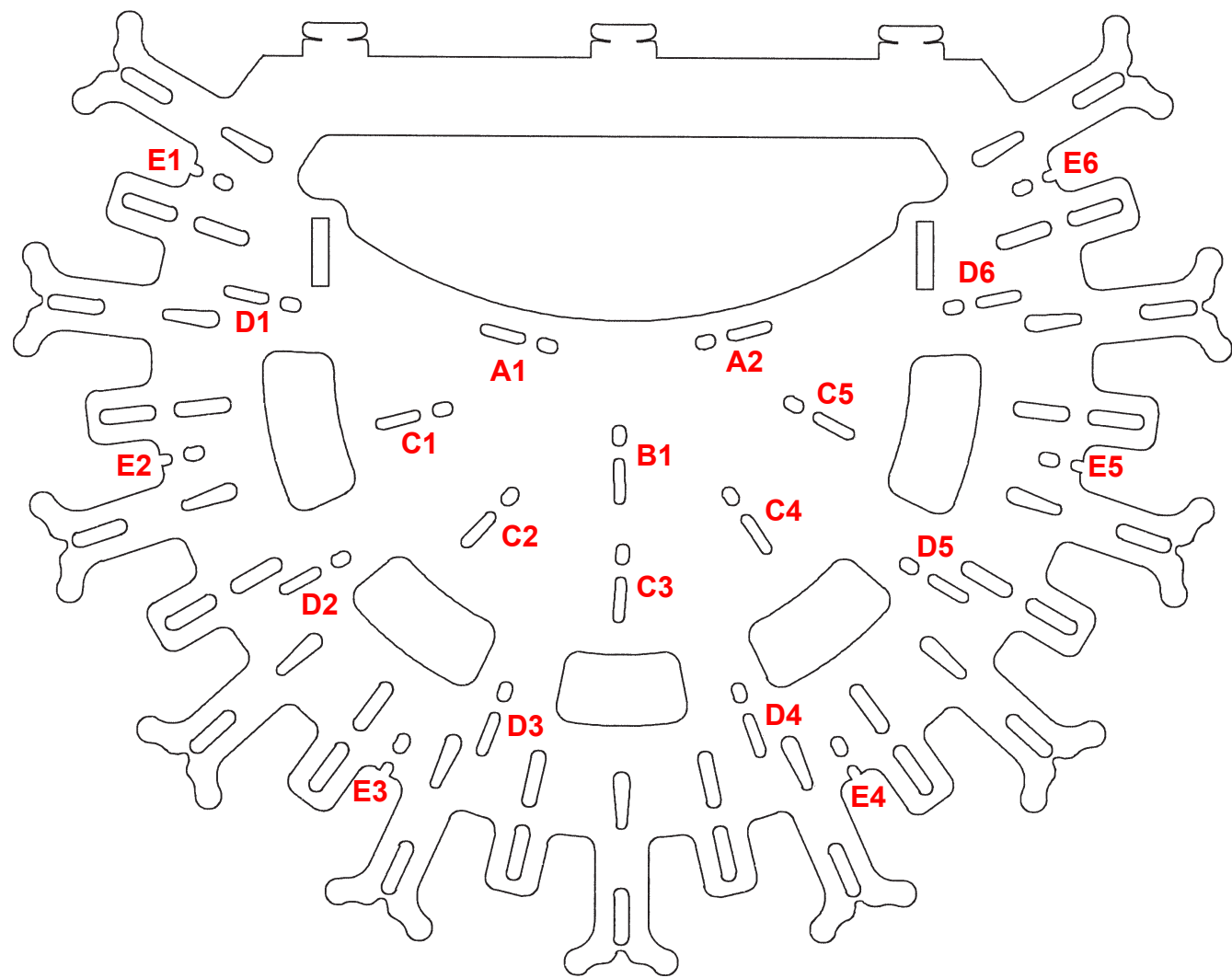

- 9** A1 - A2
- 10** B1
- 11** C1 - C5
- 12** D1 - D6
- 13** E1 - E6

After hanging all trim, remove labels from crystals. If residue remains, wipe off crystal with a soft, dry cloth.

