

SCHONBEK  
*Signature*<sup>™</sup>

NAPOLI  
S7608N-\_\_ \_\_R



**T**HIS DESIGN IS THE PROPRIETARY  
TRADE DRESS/TRADEMARK OF  
W SCHONBEK LLC.

SCHONBEK  
*Signature*<sup>™</sup>

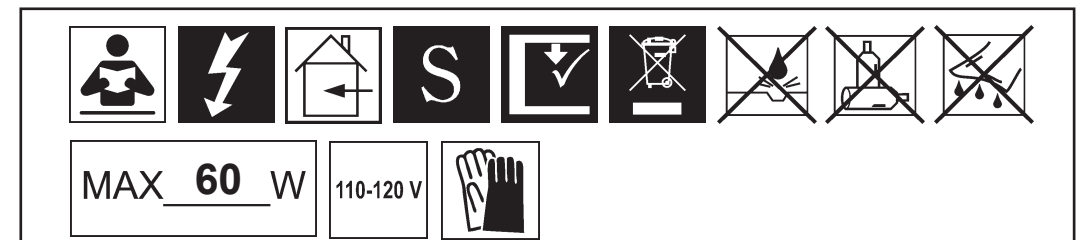

**WARNING:**

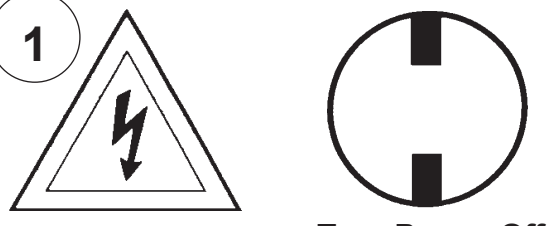

**1** Electrical Danger Turn Power Off

All electrical components must be installed by a licensed electrician in accordance with the National Electric Code and the appropriate local electrical codes.

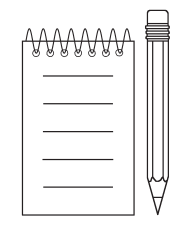
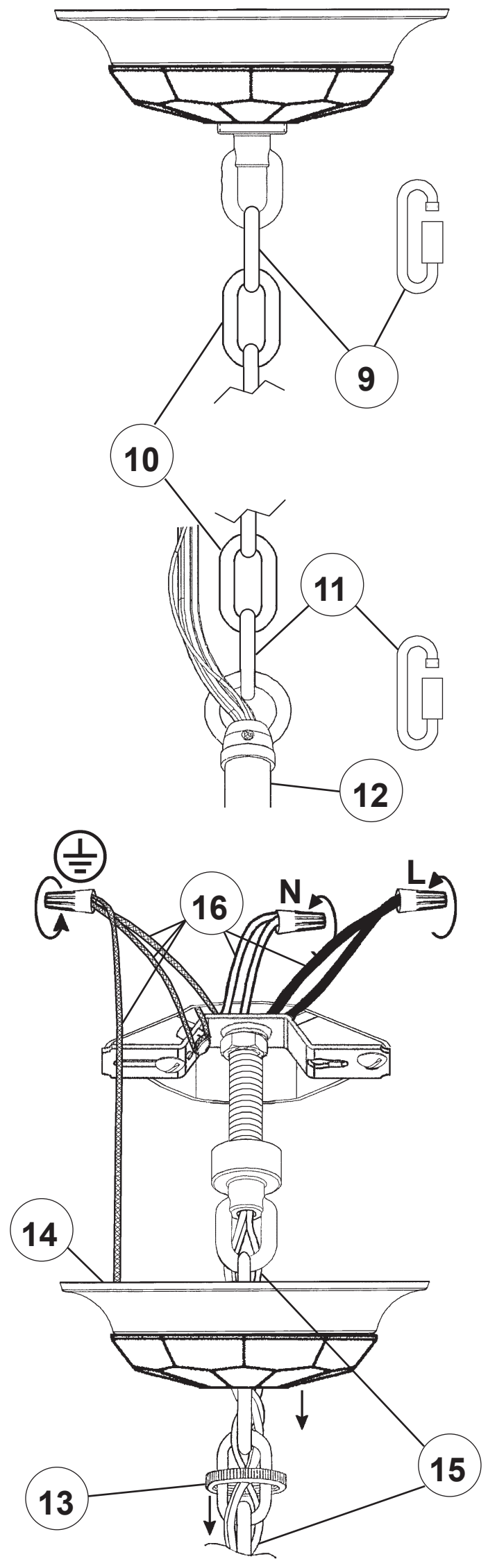
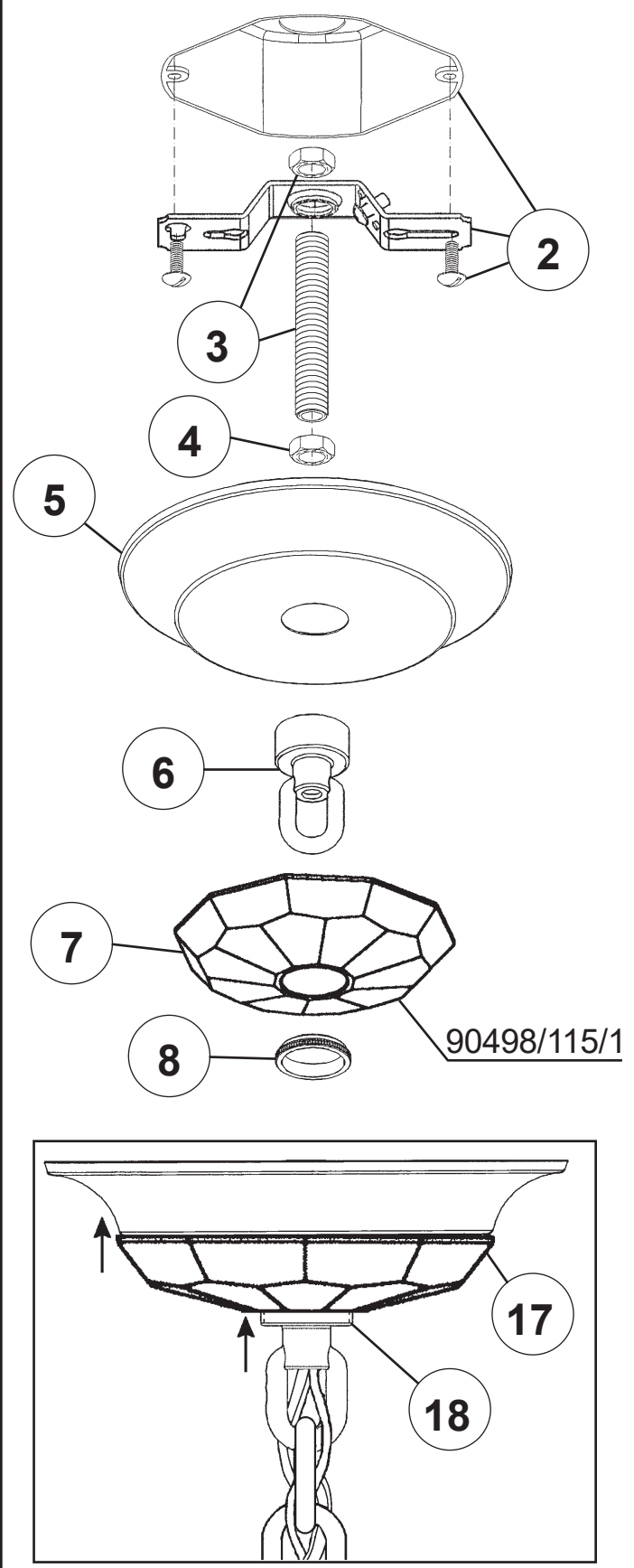

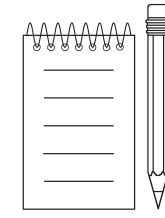
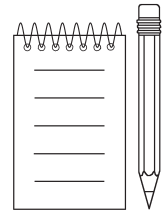

20



You will need 8 - B10  
25 Watts Recommended  
60 Watts Max

