

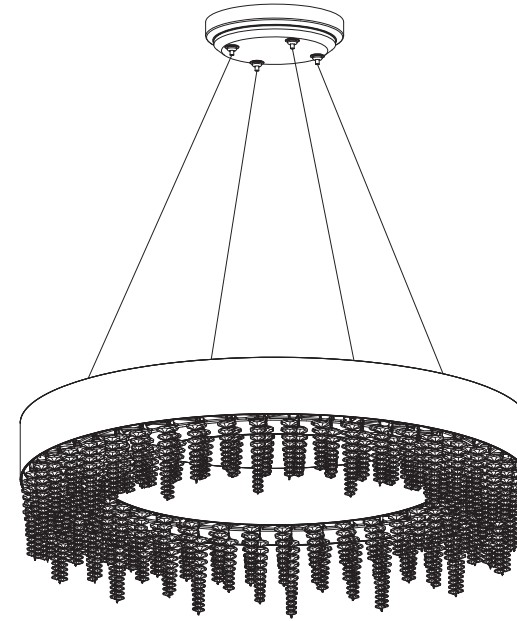









SOLEIL S3526-__O



THIS DESIGN IS THE PROPRIETARY TRADE DRESS/TRADEMARK OF W SCHONBEK LLC.

 **SCHONBEK** | 1870

 **SCHONBEK** | 1870

								
S3526: 40W		120-277 V						

WWW.SCHONBEK.COM/INSTALLATIONMANUAL

All electrical components must be installed by a licensed electrician in accordance with the National Electric Code and the appropriate local electrical codes.

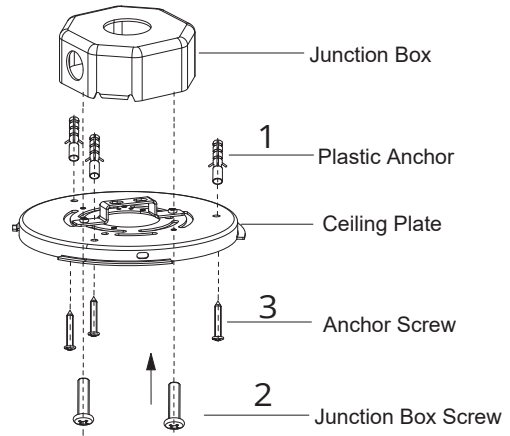

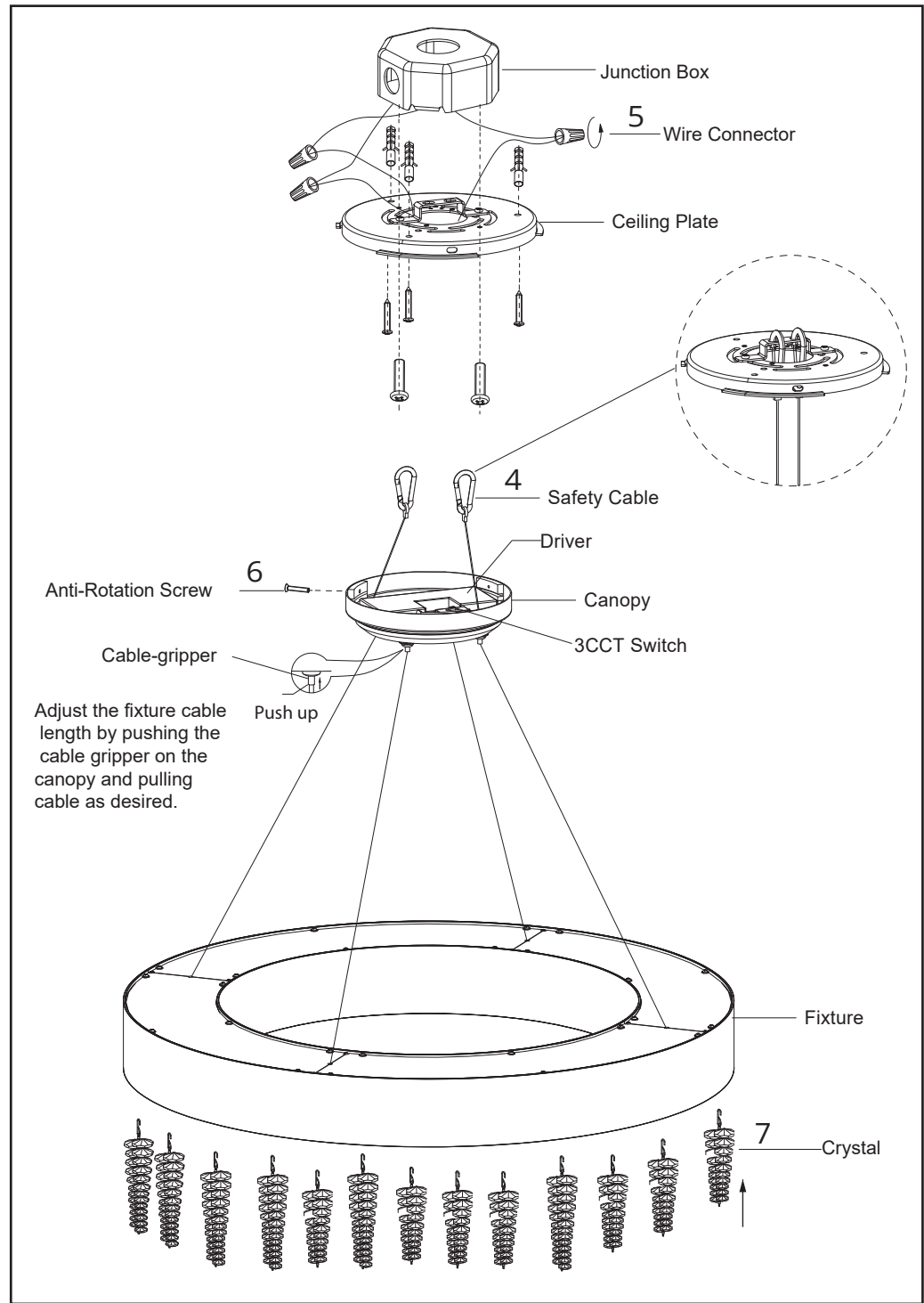
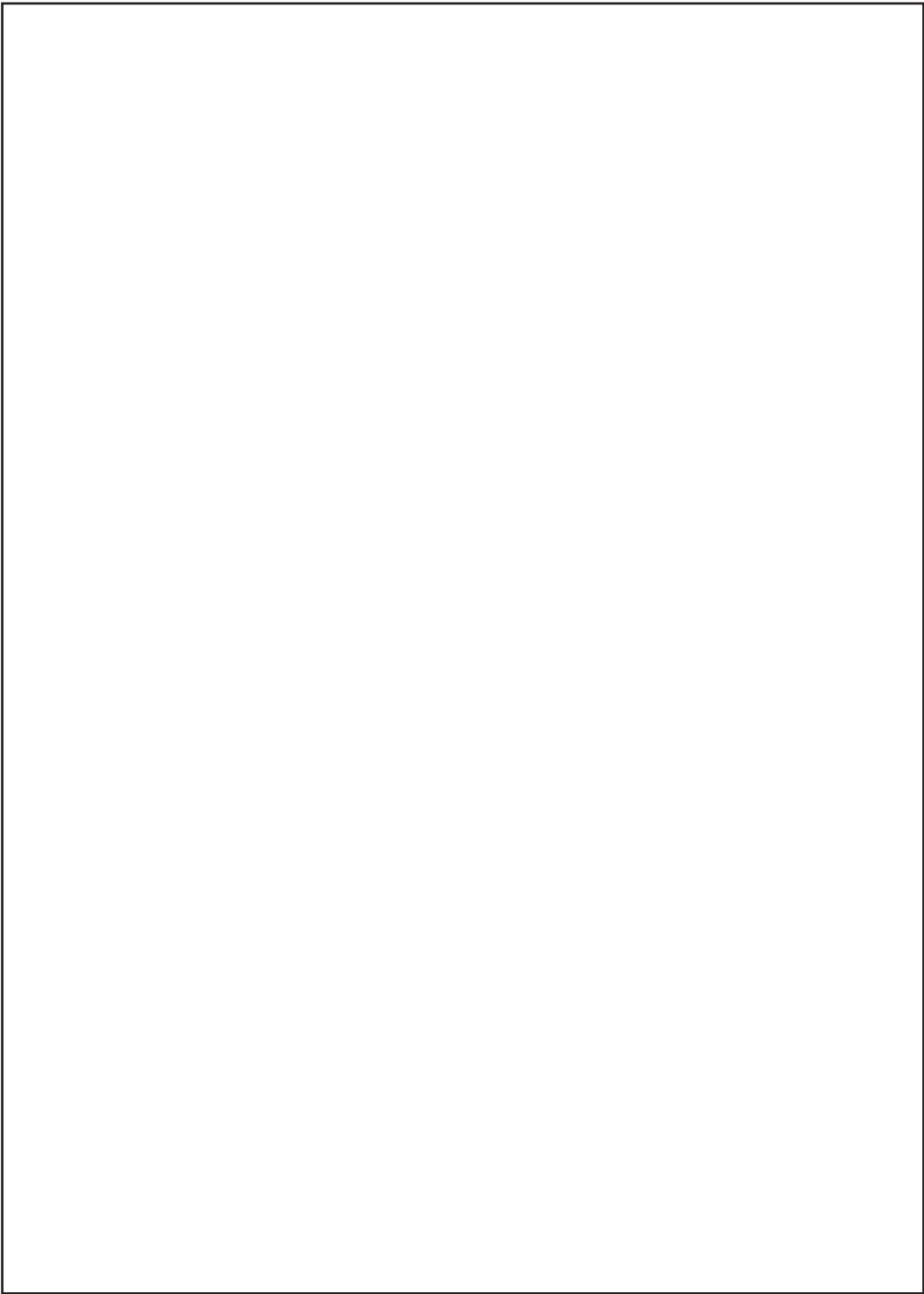

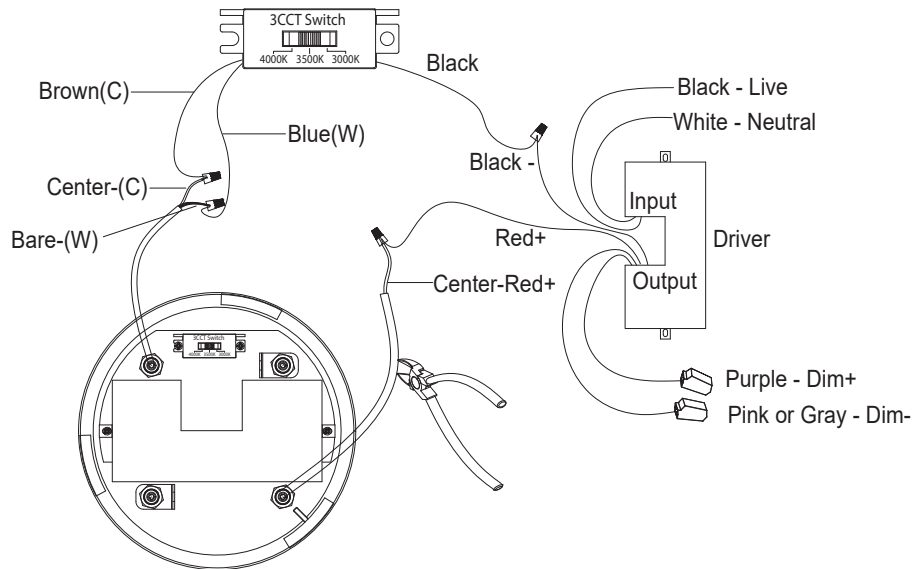
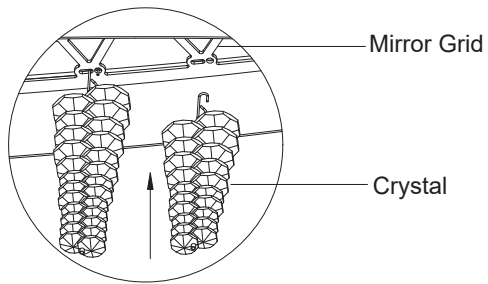

Hanging Point Chart

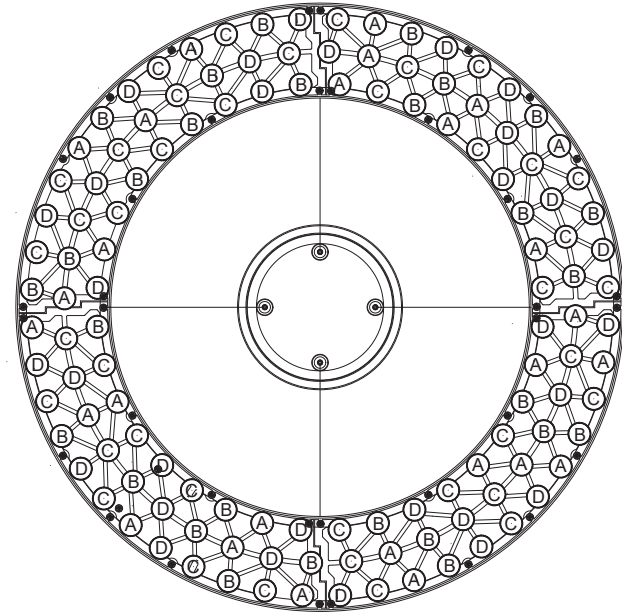

124 Hanging points(Slots)

- (A) : 27pcs
- (B) : 28pcs
- (C) : 39pcs
- (D) : 40pcs

