

 **SCHONBEK** | 1870

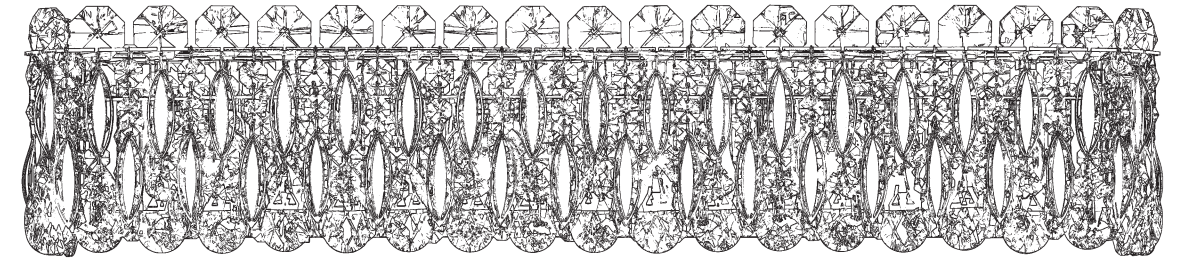









SARELLA
RS8324N- __ __ H



THIS DESIGN IS THE PROPRIETARY
TRADE DRESS/TRADEMARK OF
W SCHONBEK LLC.

6 Lights
Length: 25-1/2"
Height: 5"
Extension: 5-1/2"
Hanging Weight: 12lbs.

 **SCHONBEK** | 1870

								
MAX 40 W	110-120 V							

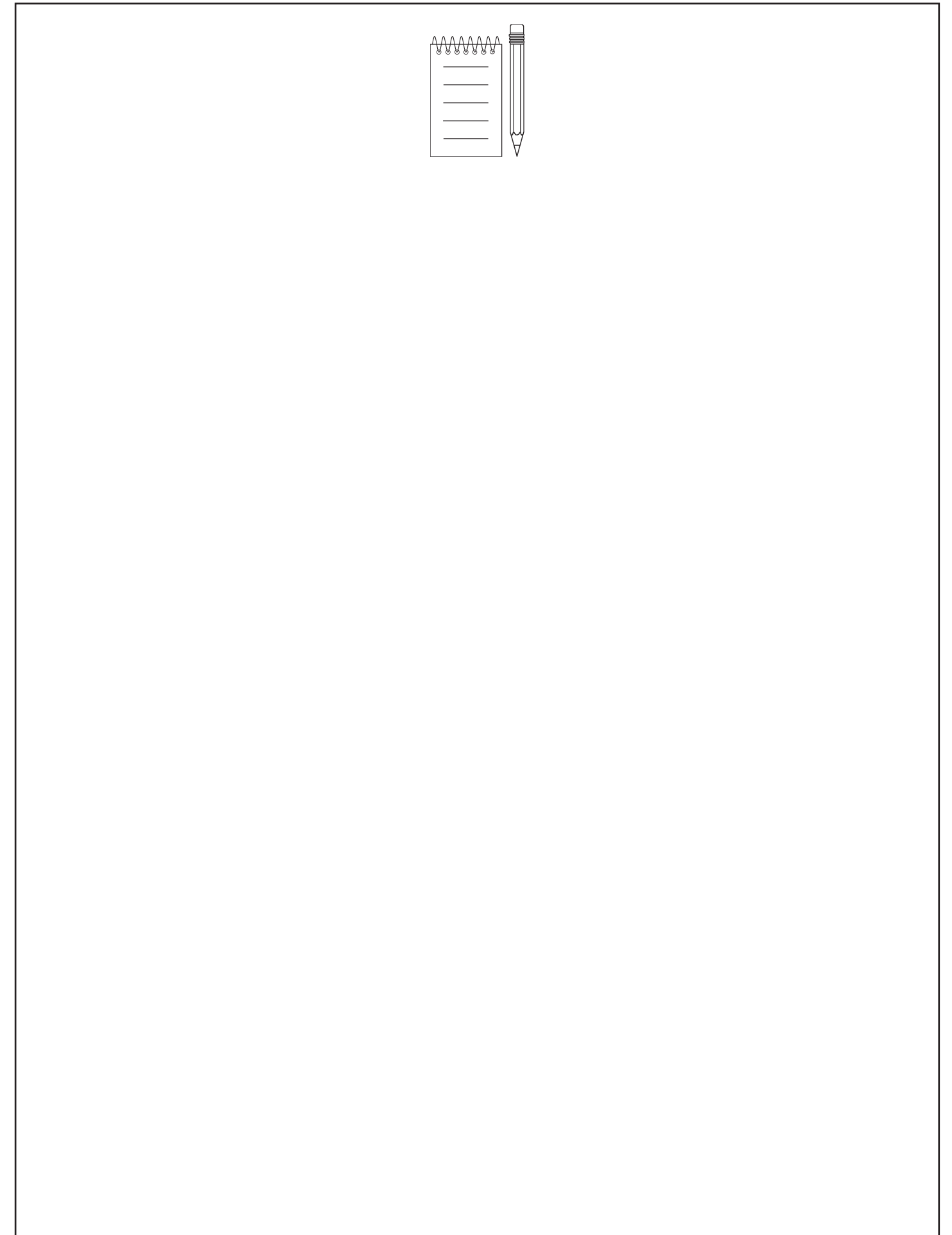
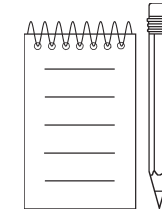
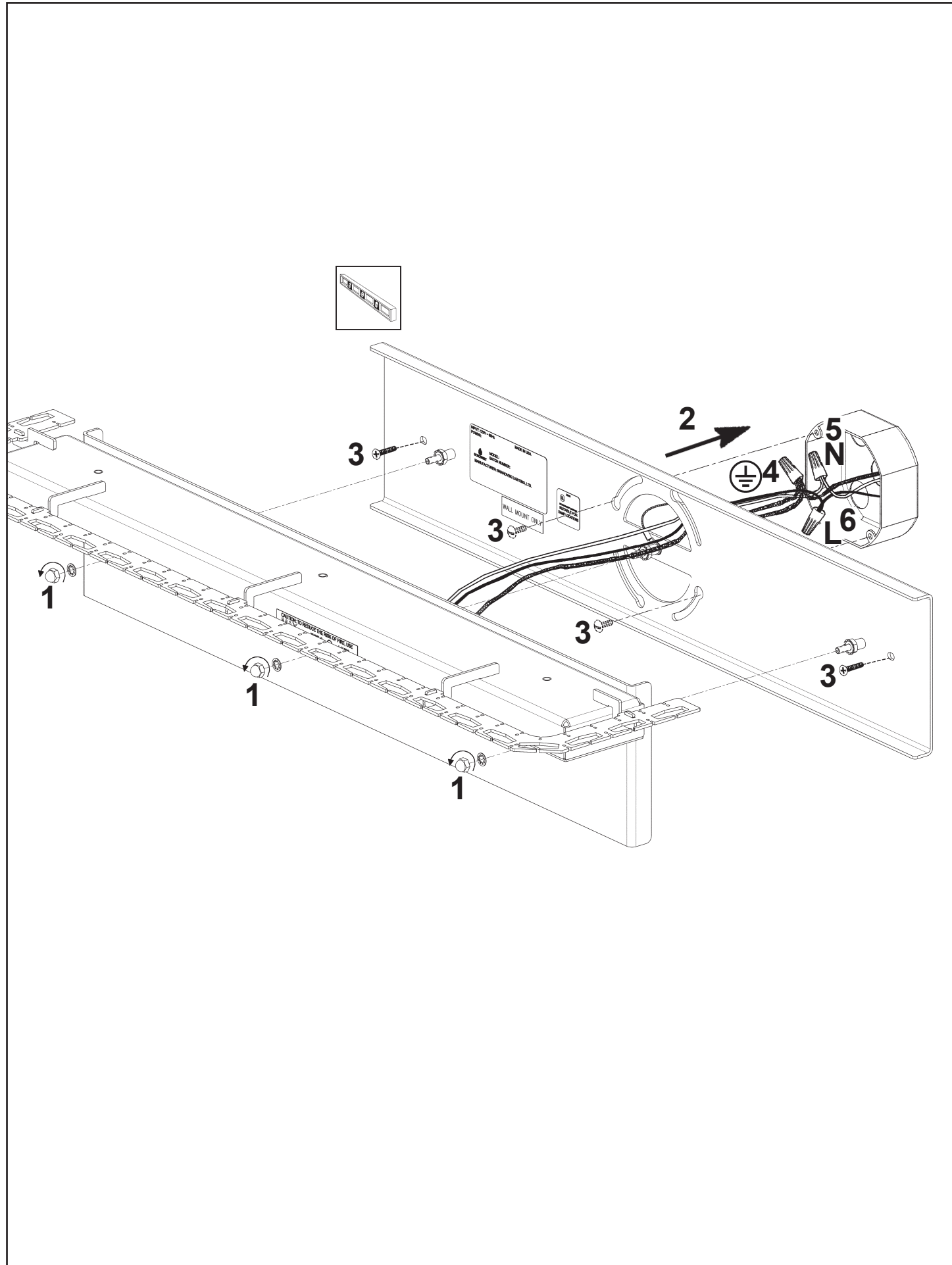

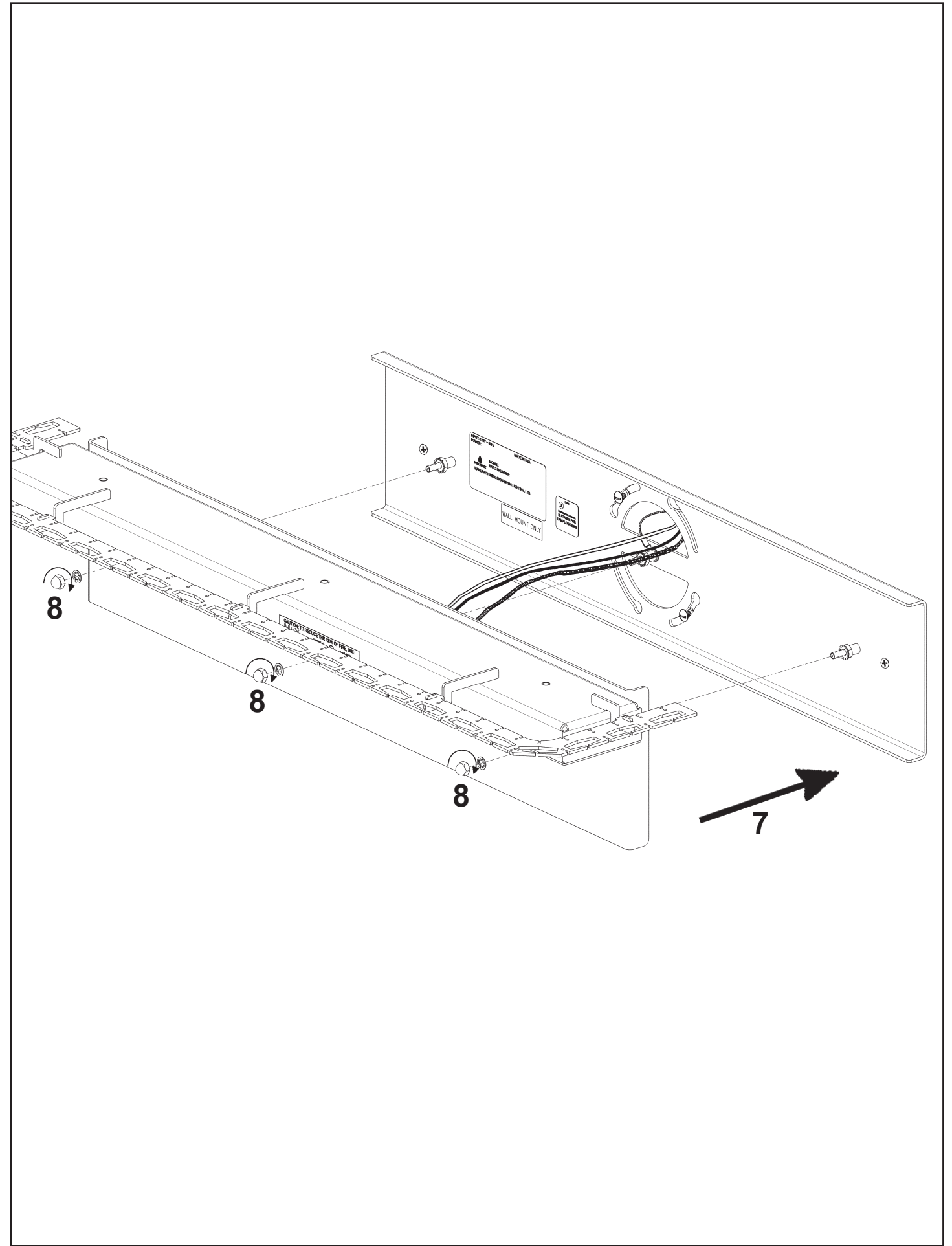
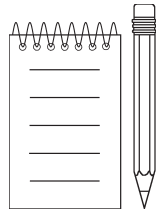

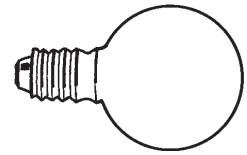

You will need 6 - G16-1/2 Bulbs
40 Watts Max

Install bulbs and be sure to
test fixture **BEFORE** trimming.

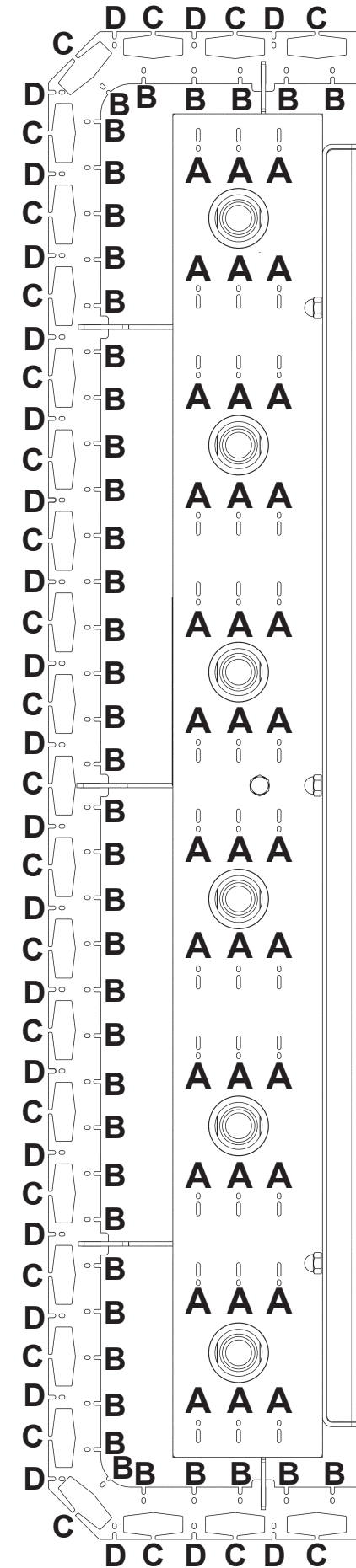
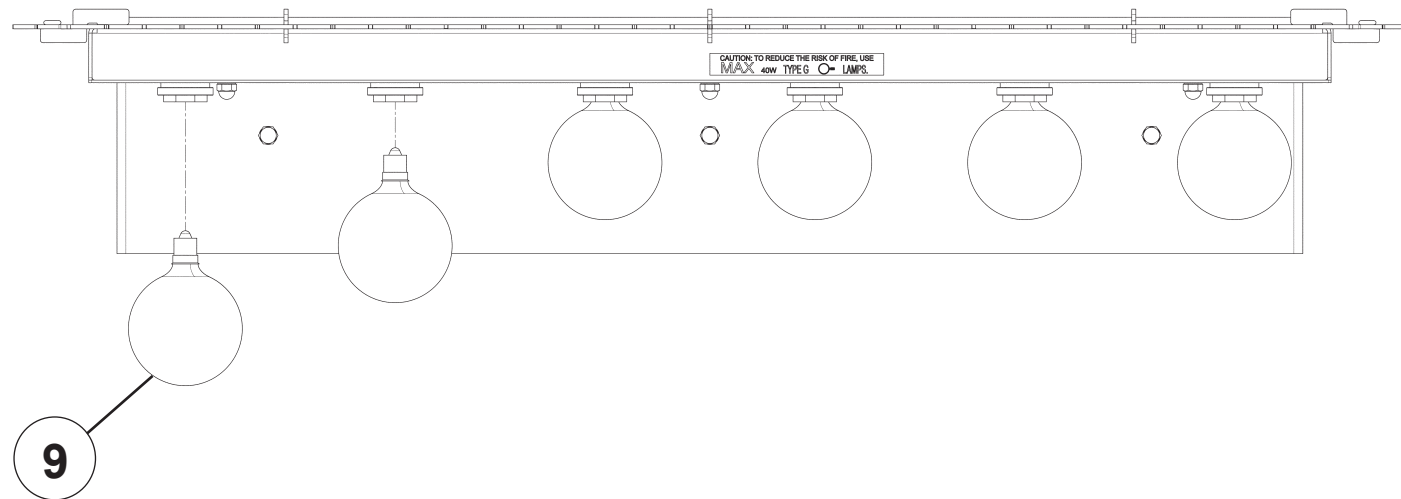

- 10 A
- 11 B
- 12 C
- 13 D

 **SCHONBEK** | 1870



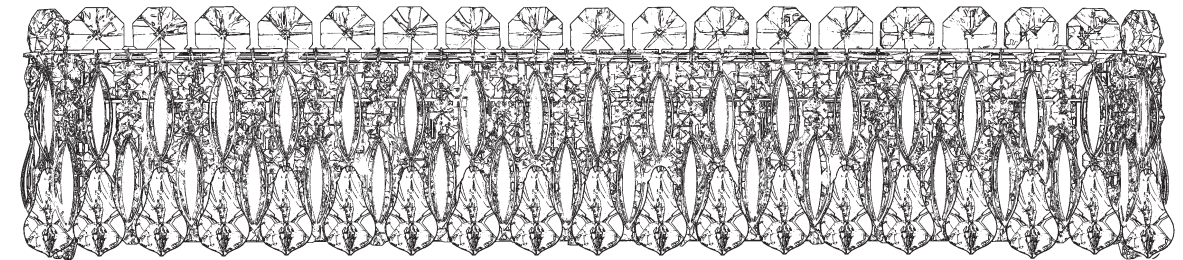







SARELLA
RS8324N- __ __ R



THIS DESIGN IS THE PROPRIETARY
TRADE DRESS/TRADEMARK OF
W SCHONBEK LLC.

6 Lights
Length: 25-1/2"
Height: 5"
Extension: 5-1/2"
Hanging Weight: 12lbs.

 **SCHONBEK** | 1870

								
MAX 40 W	110-120 V							

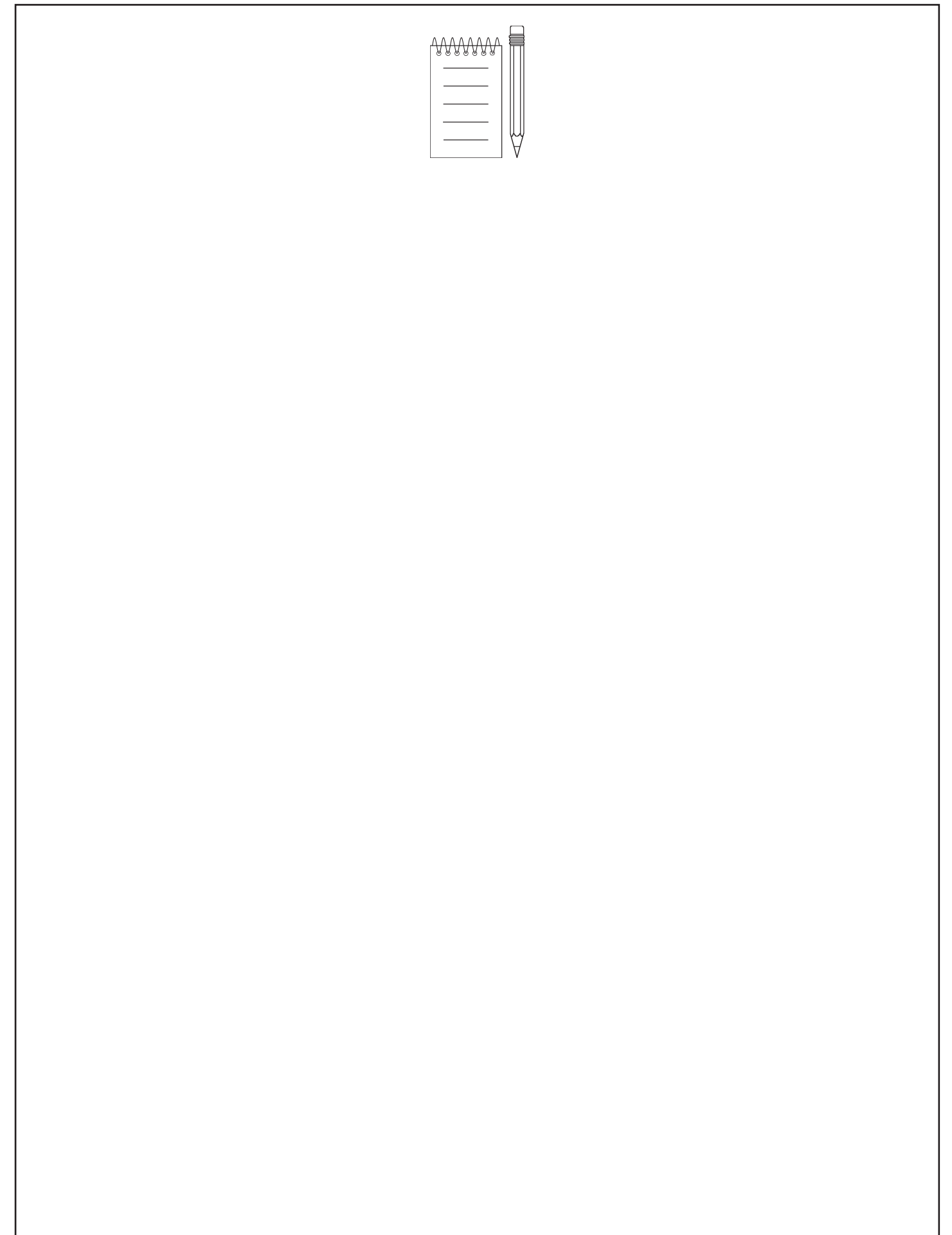
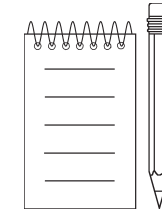
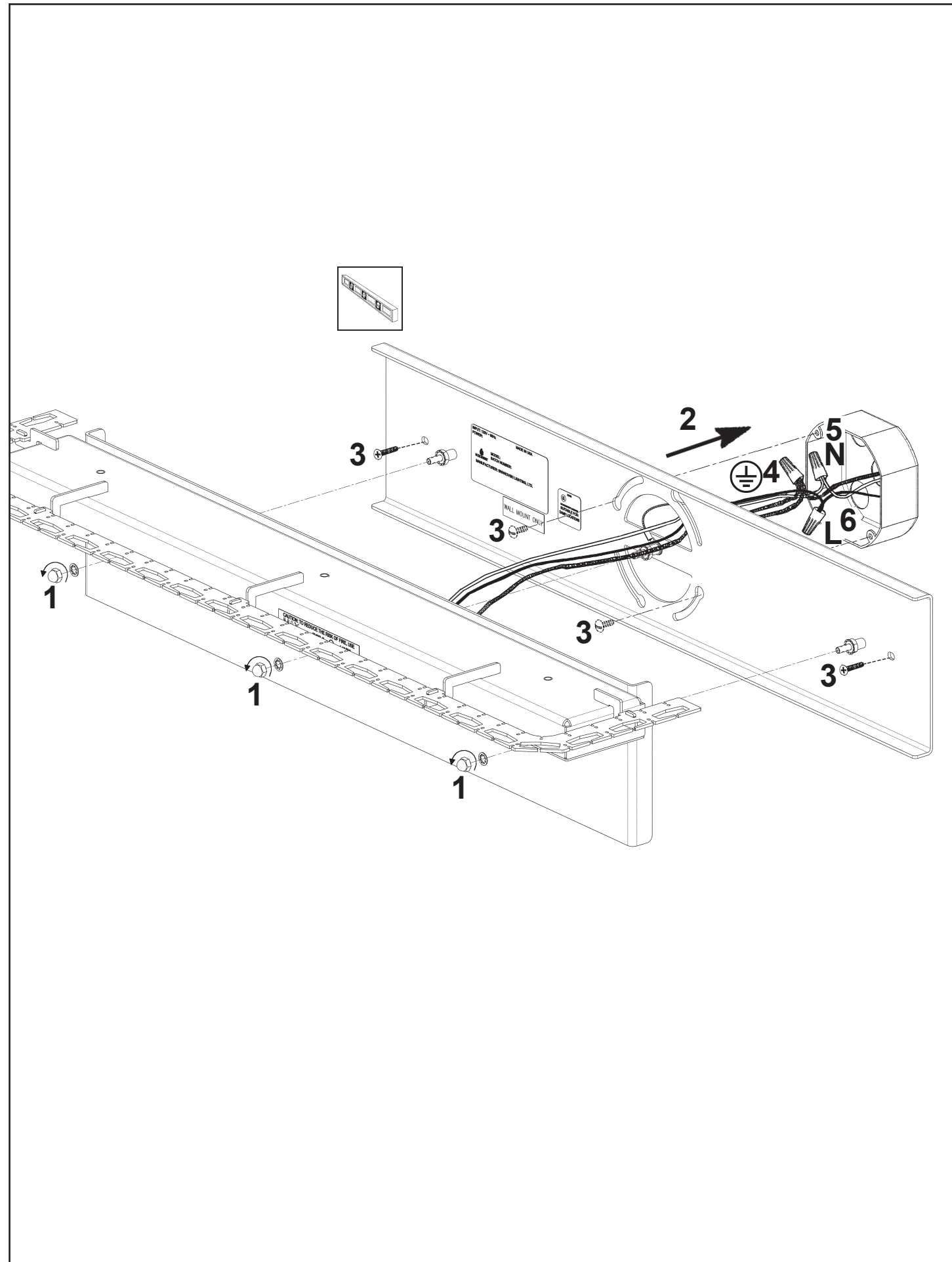

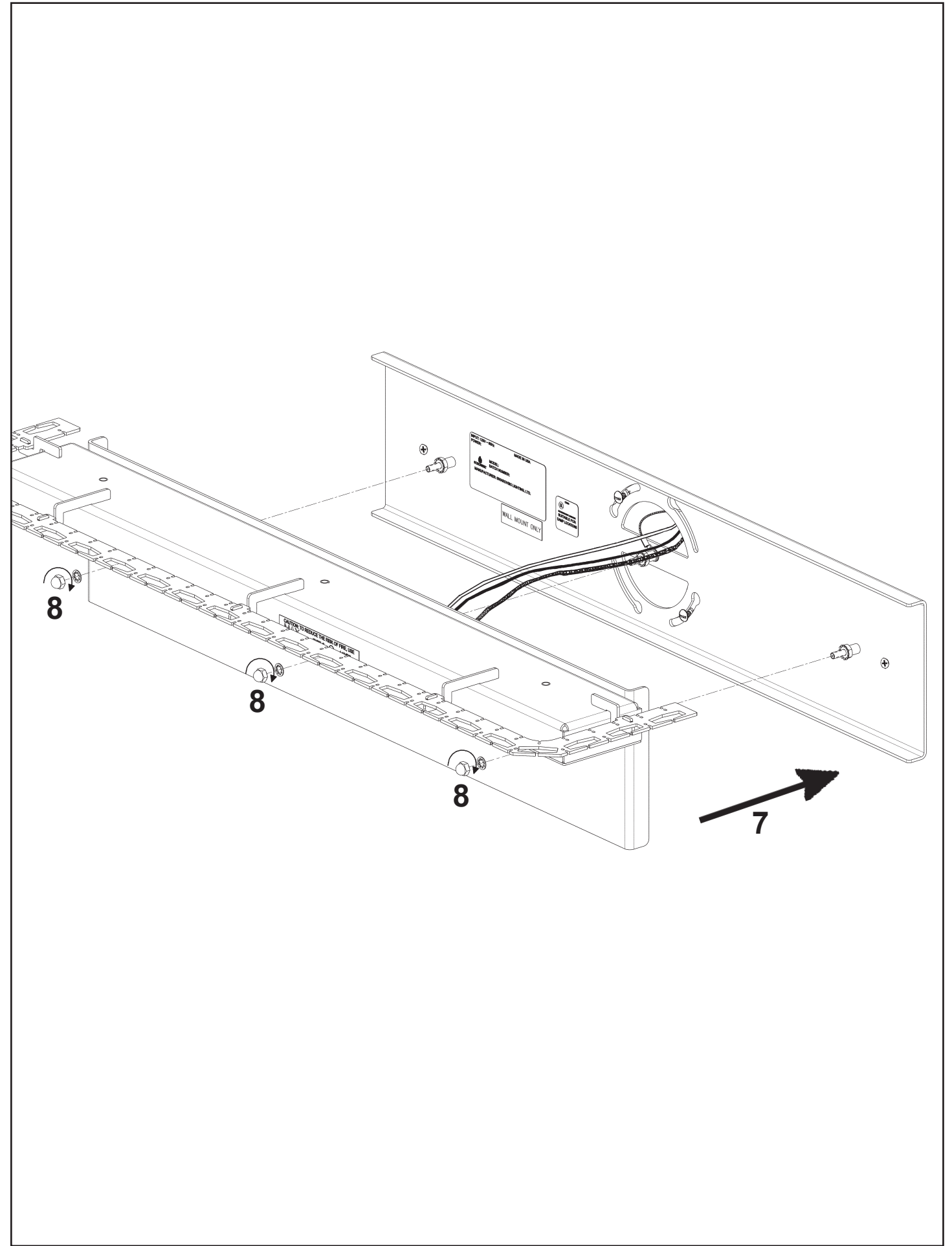
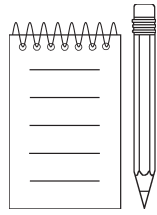

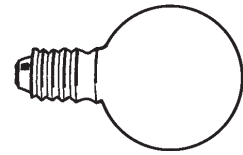

You will need 6 - G16-1/2 Bulbs
40 Watts Max

Install bulbs and be sure to
test fixture **BEFORE** trimming.

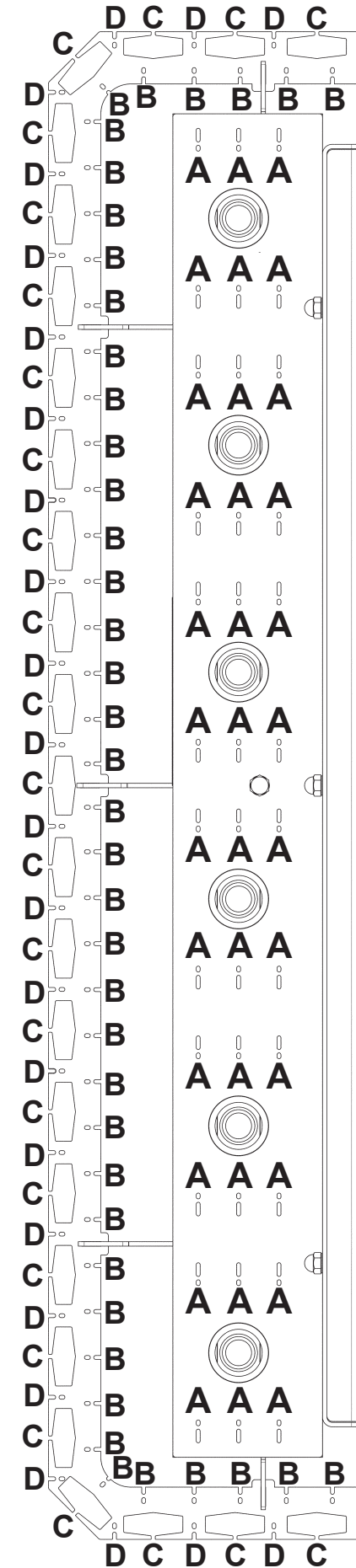
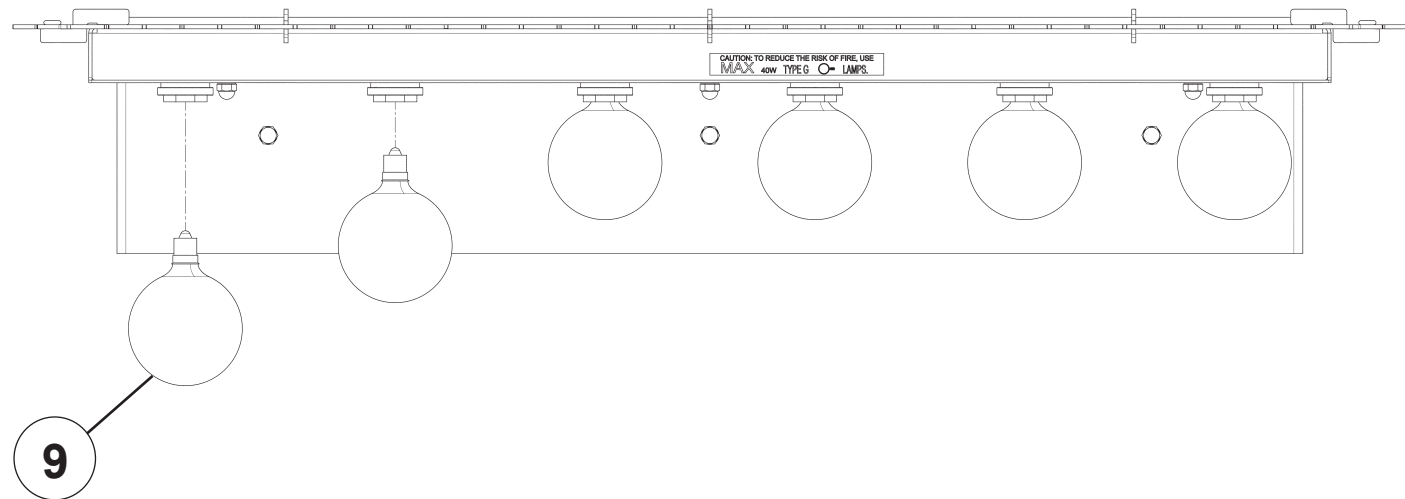

- 10** A
- 11** B
- 12** C
- 13** D

 **SCHONBEK** | 1870



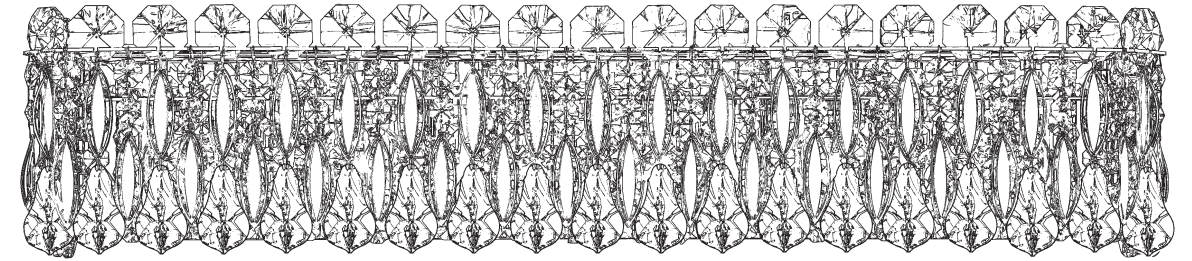







SARELLA
RS8324N- __ __ S



THIS DESIGN IS THE PROPRIETARY
TRADE DRESS/TRADEMARK OF
W SCHONBEK LLC.

6 Lights
Length: 25-1/2"
Height: 5"
Extension: 5-1/2"
Hanging Weight: 12lbs.

 **SCHONBEK** | 1870

								
MAX 40 W	110-120 V							

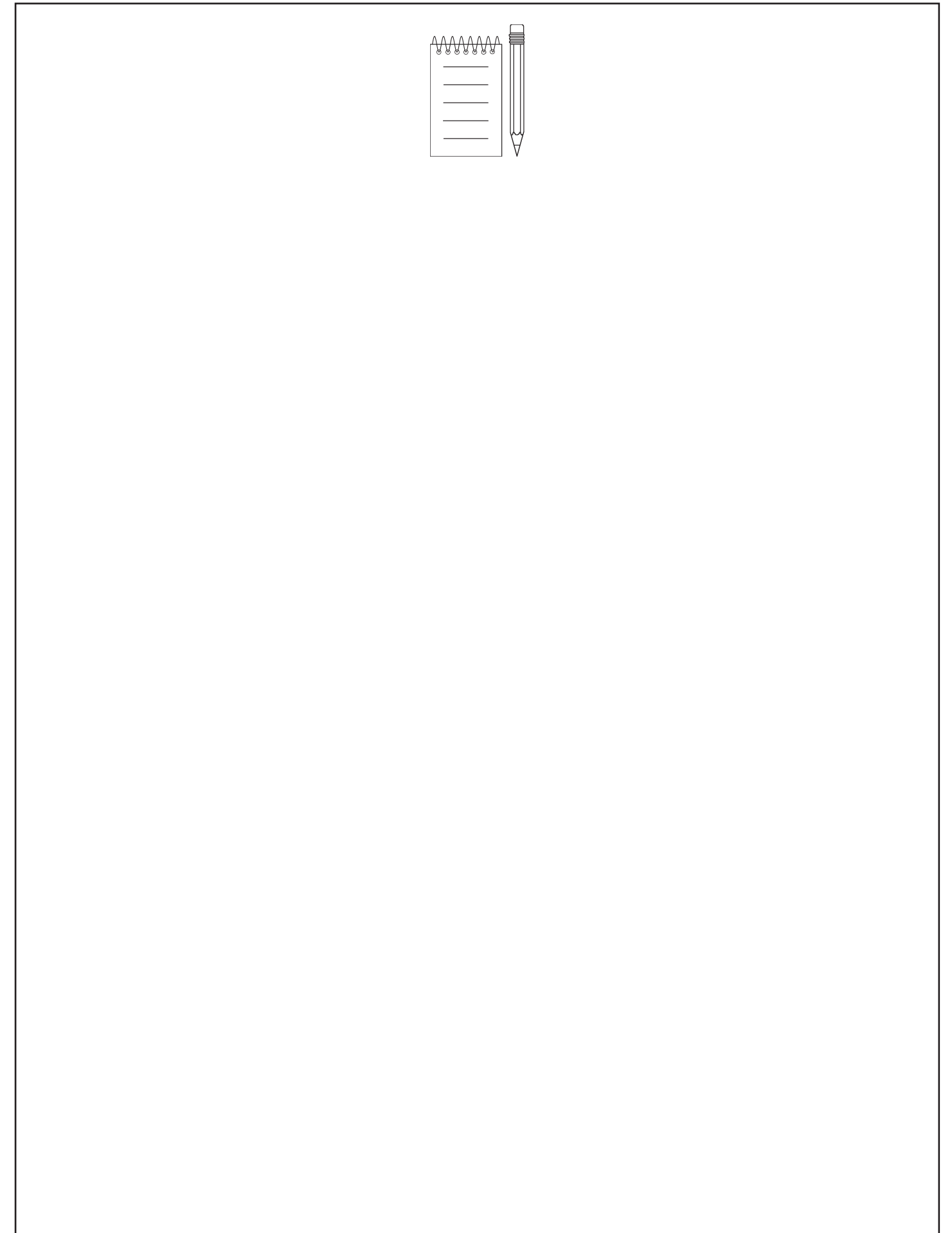
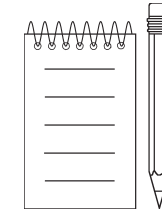
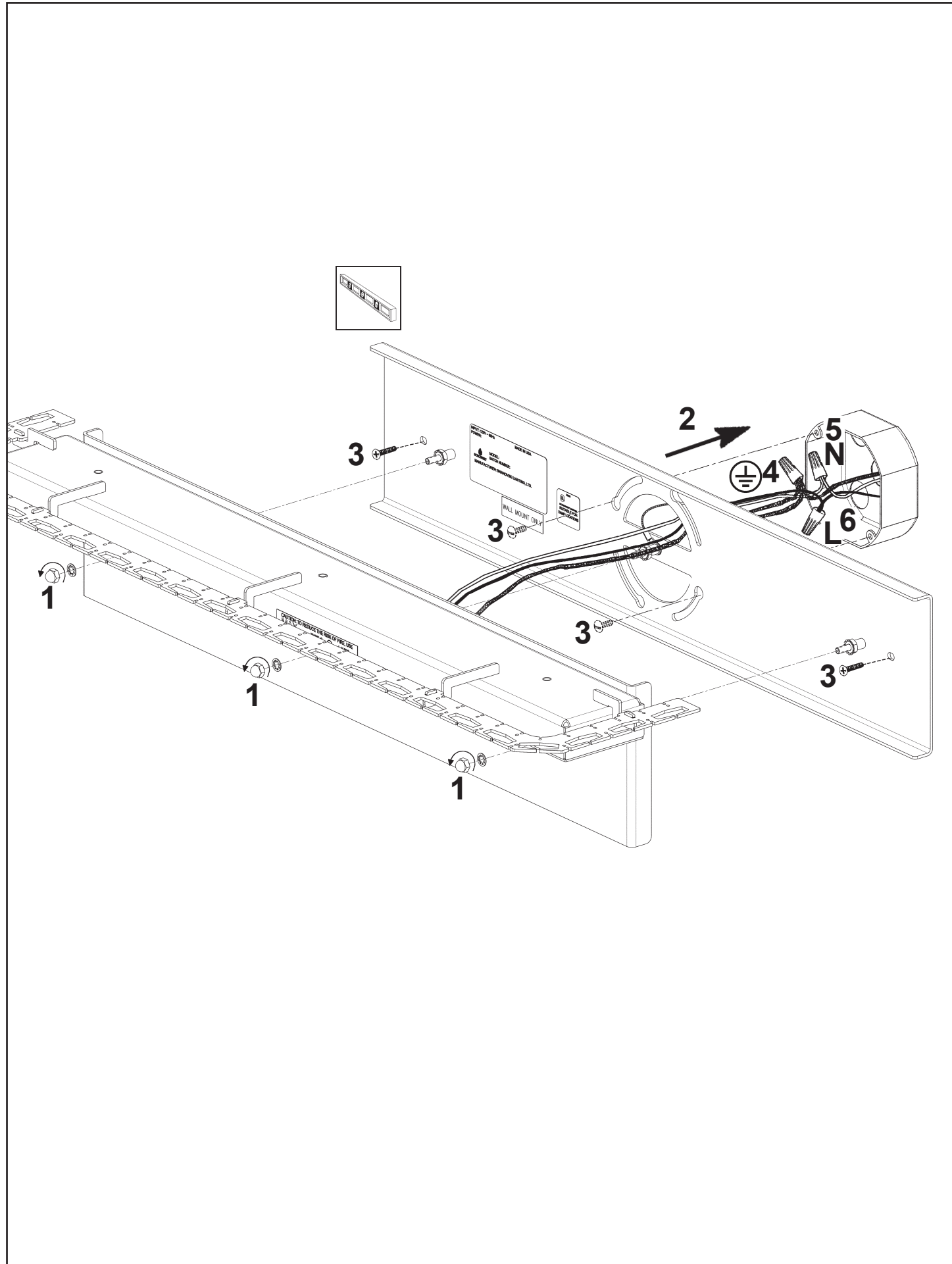

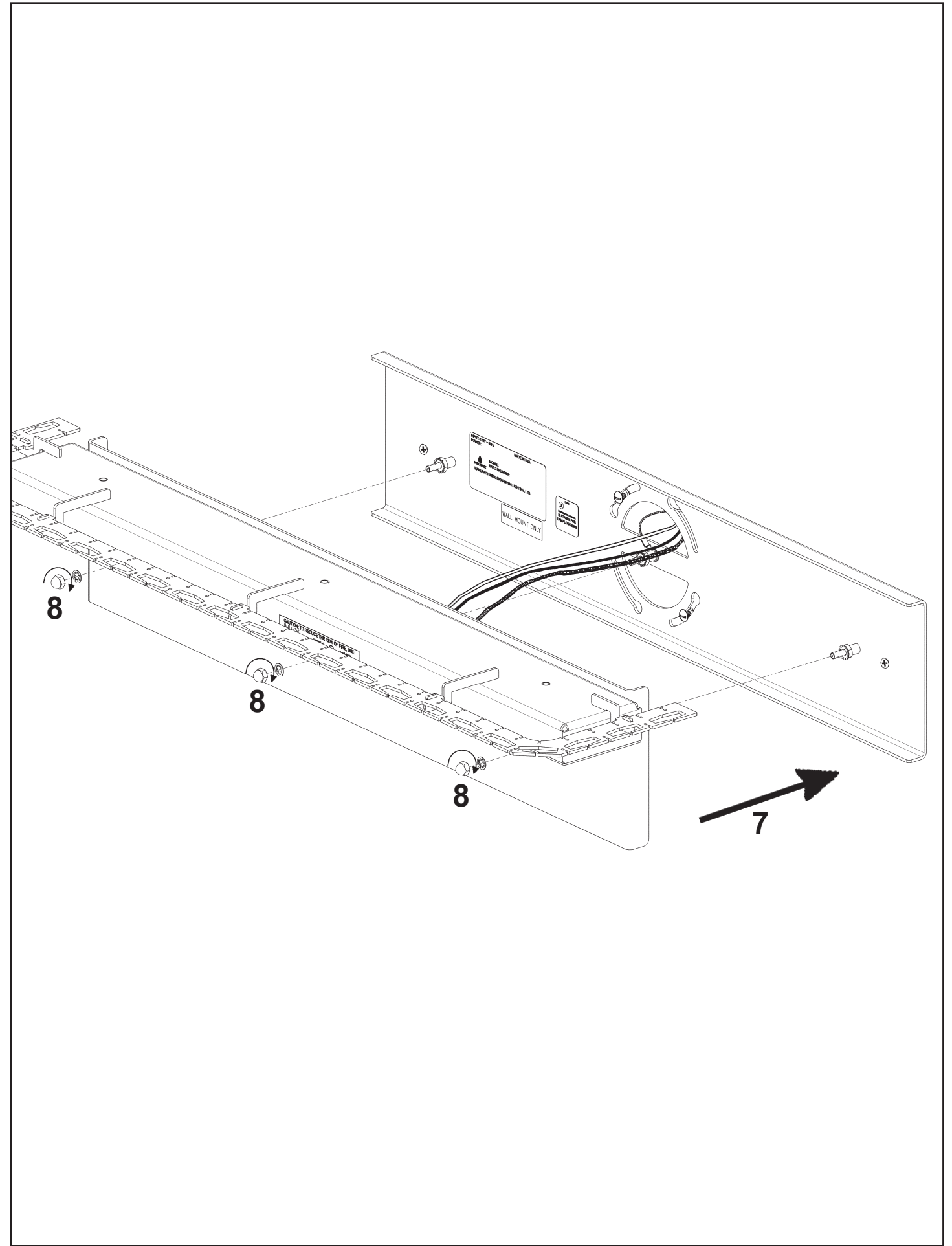
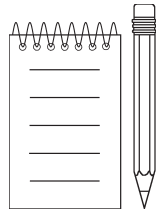

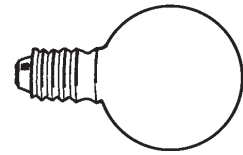

You will need 6 - G16-1/2 Bulbs
40 Watts Max

Install bulbs and be sure to
test fixture **BEFORE** trimming.

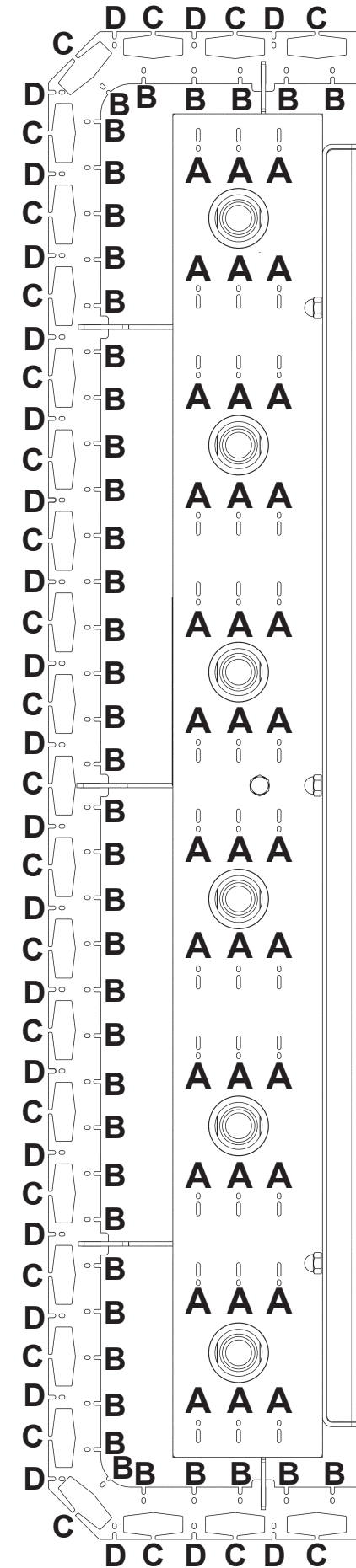
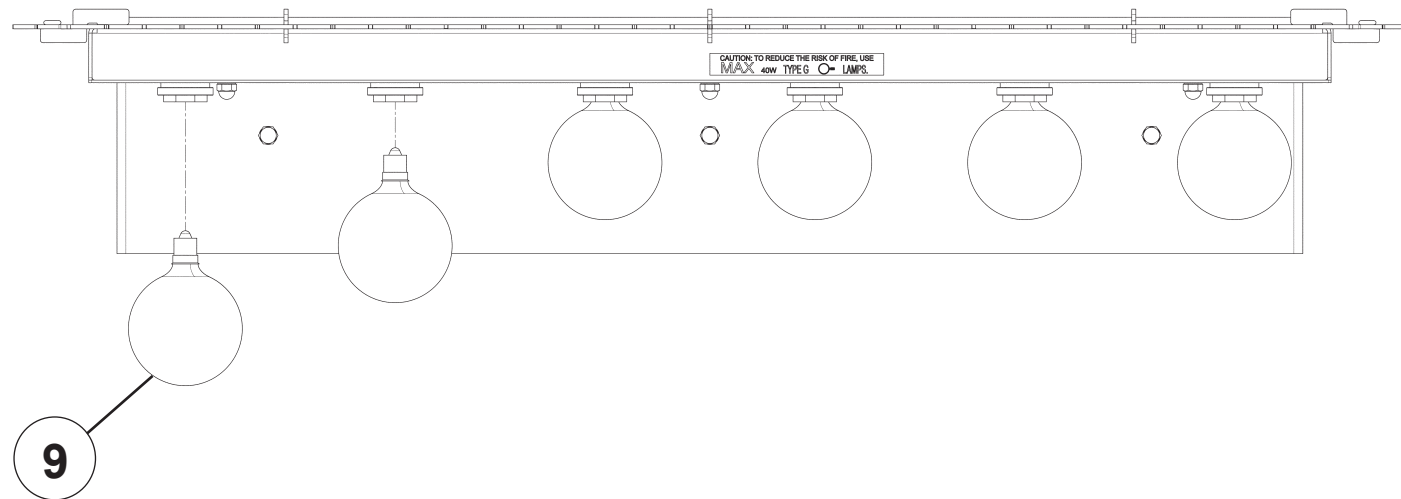

- 10 A
- 11 B
- 12 C
- 13 D