

# VERDANA RJ1012N-\_\_ \_\_O

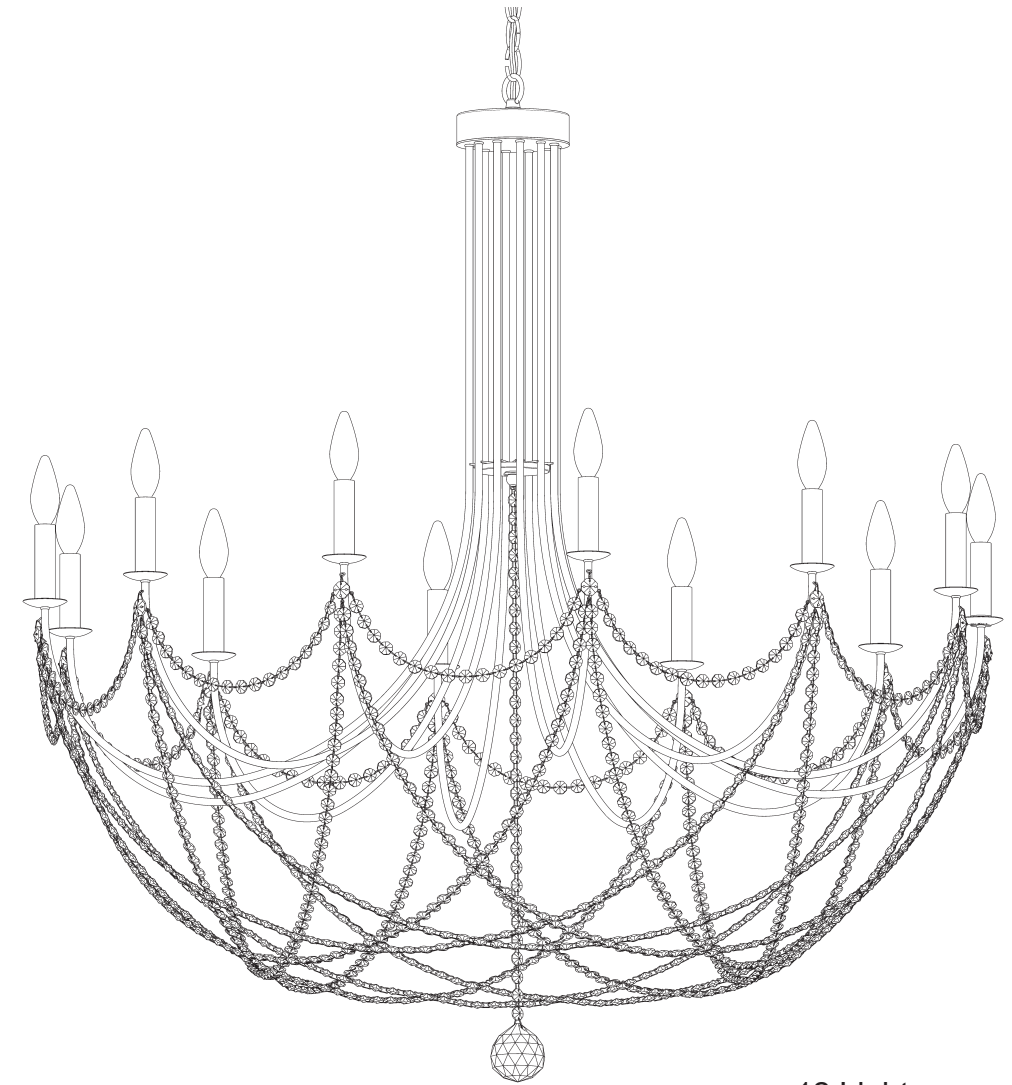











12 Lights  
Diameter: 43"  
Height: 42-1/2"  
Hanging Weight: 13lbs.

**T**HIS DESIGN IS THE PROPRIETARY  
TRADE DRESS/TRADEMARK OF  
W SCHONBEK LLC.

 **SCHONBEK** | 1870

 **SCHONBEK** | 1870

								
MAX <u>60</u> W	110-120 V							

**WARNING:**

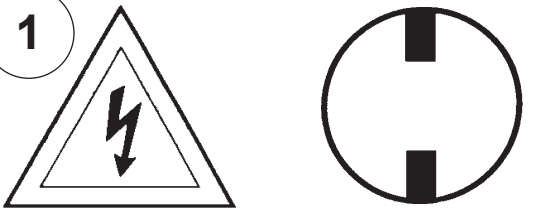
1 

**Electrical Danger Turn Power Off**

All electrical components must be installed by a licensed electrician in accordance with the National Electric Code and the appropriate local electrical codes.

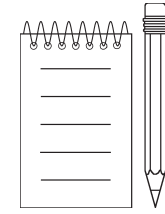
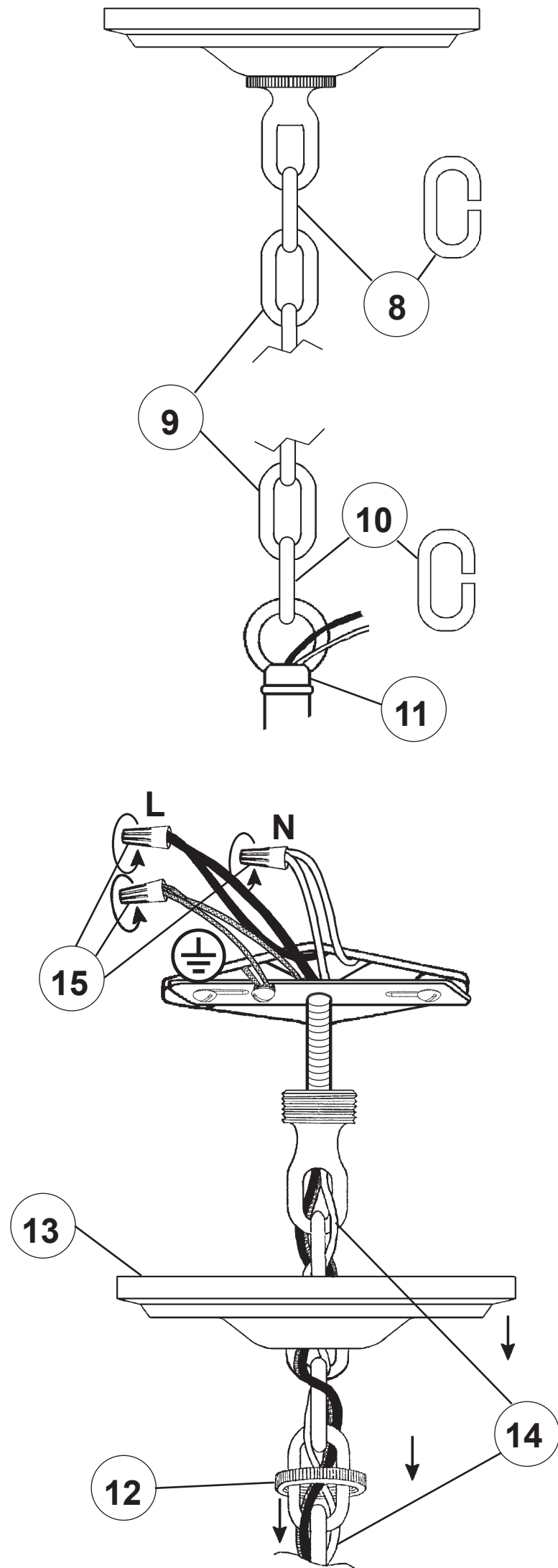
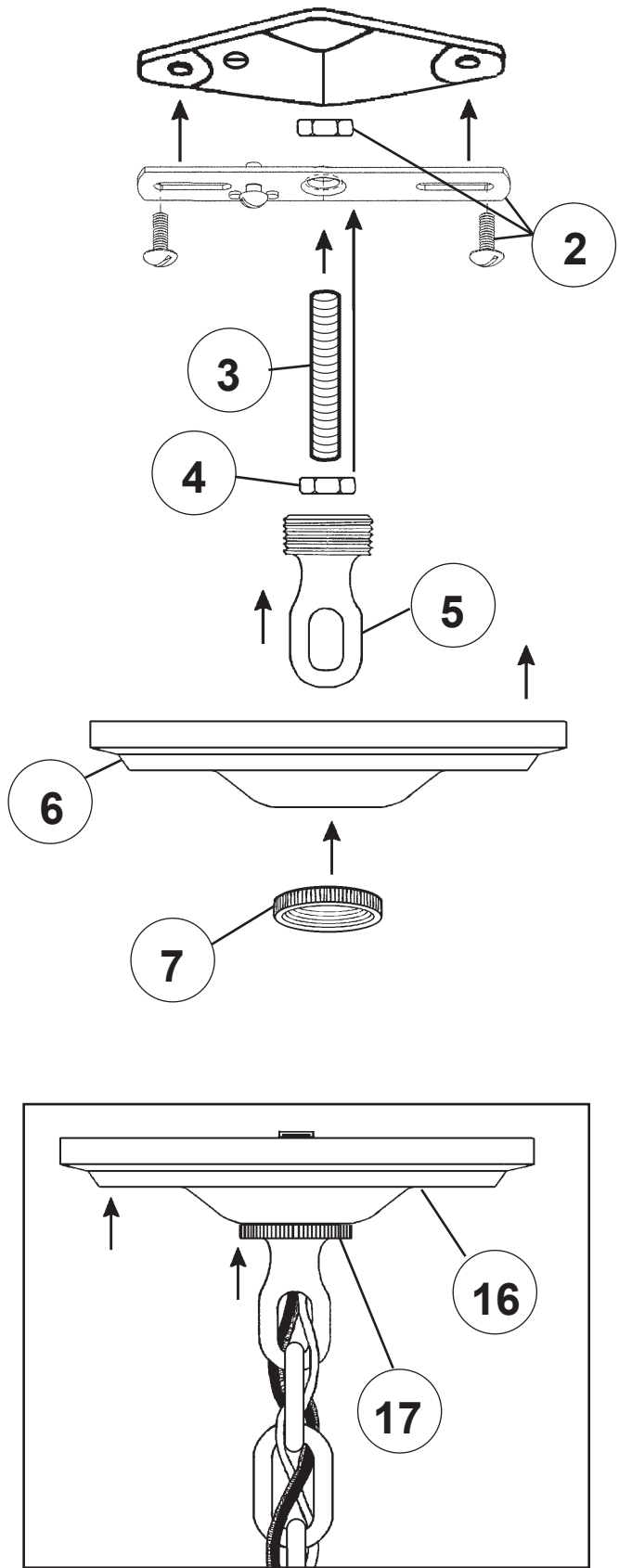

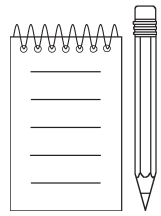

18

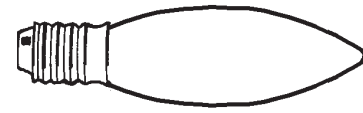

You will need 12 - B10  
60 Watts Max

Install bulbs and be sure to  
test fixture **BEFORE**  
trimming.

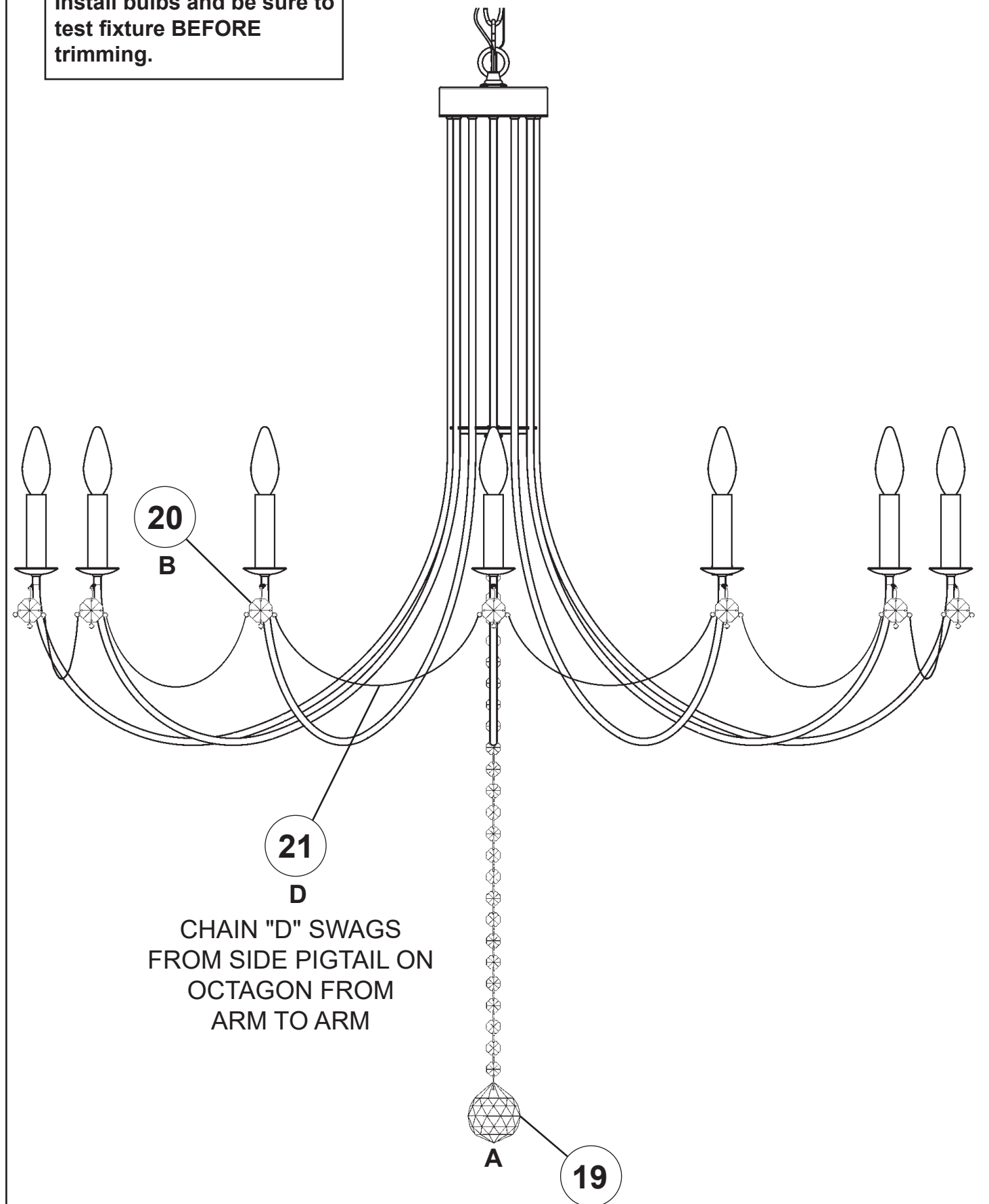

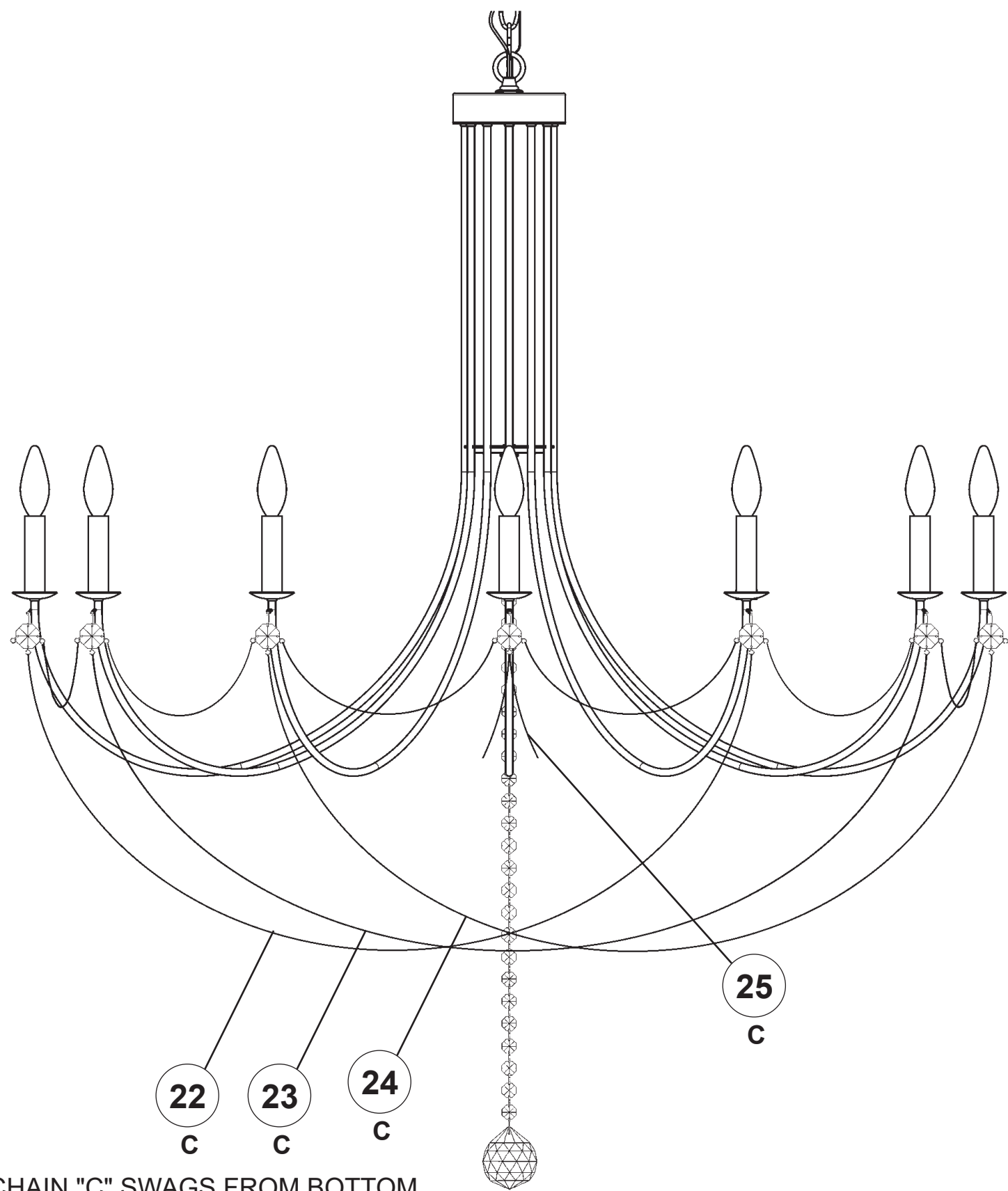

CHAIN "C" SWAGS FROM BOTTOM  
 PIGTAIL ON OCTAGON OF ONE ARM TO  
 THE BOTTOM PIGTAIL ON OCTAGON  
 OF EVERY FOURTH ARM -  
 REFERENCE DIAGRAMS 1 - 4

**DIAGRAM 1  
 (BOTTOM VIEW)**

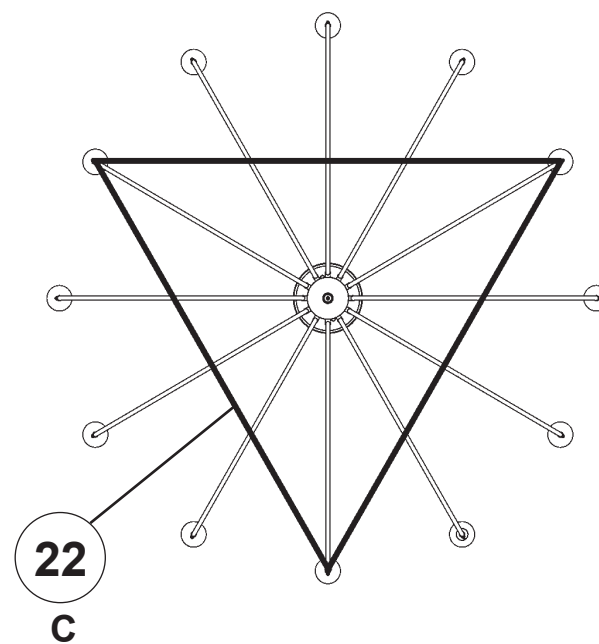

**DIAGRAM 2  
 (BOTTOM VIEW)**

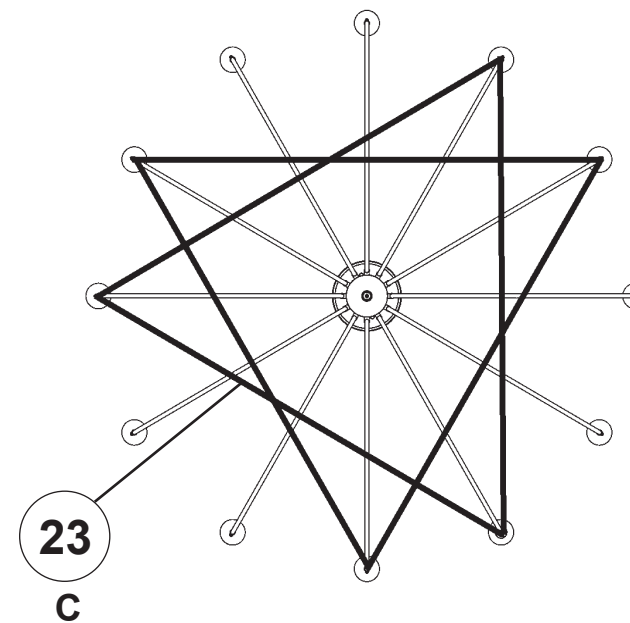

**DIAGRAM 3  
 (BOTTOM VIEW)**

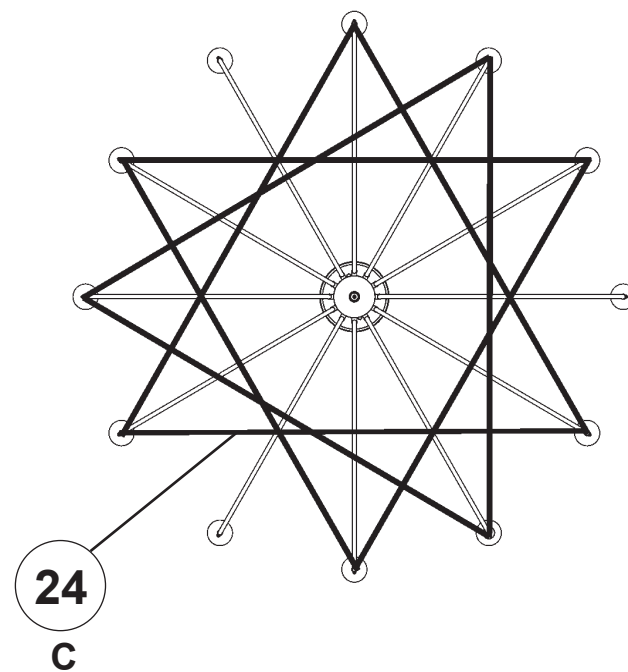

**DIAGRAM 4  
 (BOTTOM VIEW)**

