

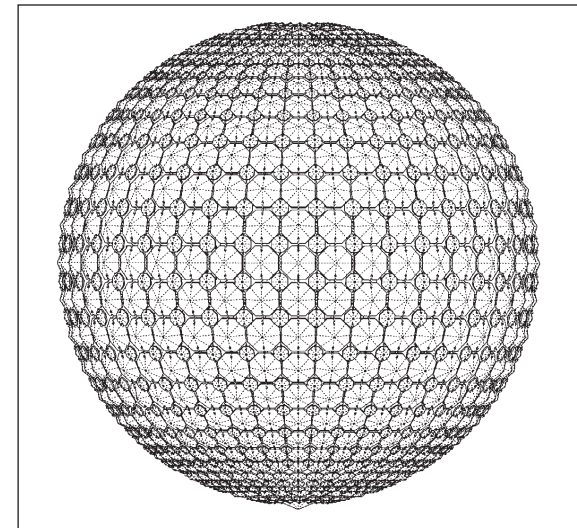

Trim Diagram
da Vinci™ Chandelier DV18180



18 Lights
Diameter: 18"

This design is the proprietary trade dress/trademark of W Schonbek LLC.

Please save your trim diagram for future reference.

IMPORTANT: Label on back contains important information on your crystal color. Please save in case you ever need to order matching crystal.

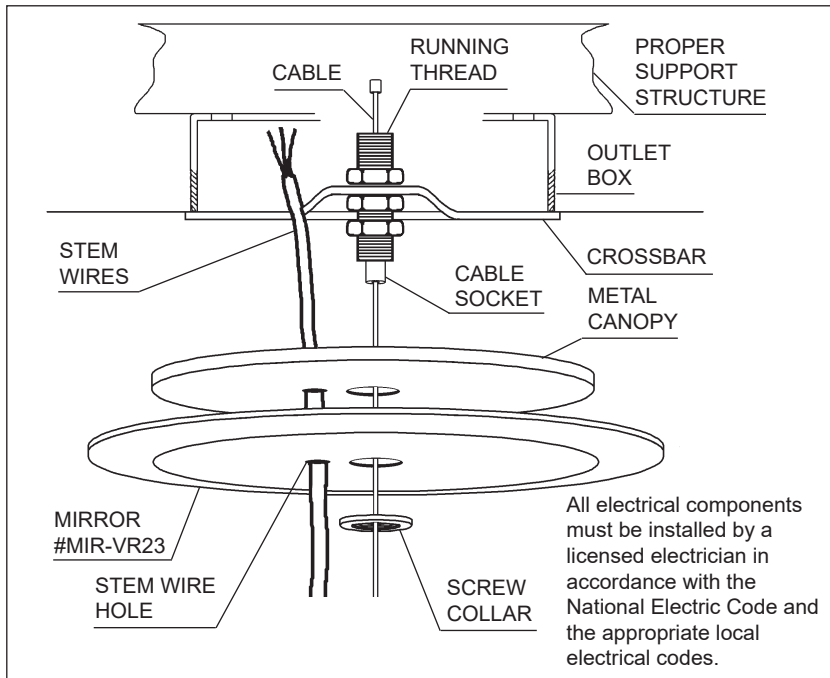

How to Install Canopy:

1 Remove the screw collar, mirror, metal canopy from the canopy assembly and attach crossbar using hardware (not provided) to outlet box. Feed suspension cable through running thread from the top so that the cast cable end is seated in the inside of the cable socket. Attach crossbar to the ceiling with cable hanging down. Feed suspension cable through the center hole (larger hole) of the canopy, mirror and then screw collar. The metal canopy must be finish side down and on top of the mirror with beveled side down. Loosen the safety nut by turning it counter clockwise and depress it in order to feed the cable into cable glider on chandelier frame and hang to desired height. Slide cable into glider and allow it to play out of the bottom of the frame temporarily. To adjust height, hold the frame with one hand while depressing the safety nut with the other hand until the cable is released. Feed stem wire through stem wire hole in mirror and metal canopy (the smaller hole). When chandelier is at desired height, trim stem wire and connect ground wire (marked with green tracer) and power wires (black or white tracers) in outlet box. Raise metal canopy and mirror to ceiling and secure to running thread with the screw collar. Supplied are 4 cable grips. Clip to support cable and adjust along stem wire as desired. Suspension cable will exit the side of chrome spike. Cut excess cable off with cable cutters.

2 Plug bulbs carefully but completely into socket. Be sure NOT to handle bulbs with bare hands. Use only G9 JCD bulbs marked "suitable for open luminaires" OR bearing this symbol:



Frequency of cleaning crystal

We know people who clean their crystal every few months, because they love handling the crystals and admiring them close up. Others do a cleaning every six or nine months.

To stretch the time between cleanings, dust lightly every two or three months with a feather duster, lambswool duster or make-up brush.

Frequency of cleaning depends on location of your Da Vinci and other environmental factors.

Crystal needs cleaning when it appears dusty or dull. Just look at your Da Vinci frequently (always enjoyable), and you'll know when it's time for a cleaning.

How to clean your Da Vinci:

Your Da Vinci is dishwasher safe!

- 1** Wash Da Vinci in its own cycle. Do NOT wash with silverware or dishes.
- 2** Carefully place crystal sections in dishwasher. Make sure that the crystal sections are not touching each other as this could cause chipping.
- 3** Use good quality detergent and anti-spotting rinse following the instructions of the dishwasher manufacturer. Cleaners with bleach or ammonia should NOT be used.
- 4** Allow crystal panels to cool before handling and reassembling your Da Vinci. If sections are brought directly from the hot dishwasher to a cold area, the drastic temperature change could cause crystal to crack.
- 5** Put on gloves to handle your now clean crystal sections. See page 4 for assembly instructions.

REPLACING CRYSTAL:

If a crystal breaks, you'll see a bare spot in the framework. You will need a set of needlenose pliers to replace the crystal. Make sure when placing pliers onto the metal tab that the ends of the pliers do not go beyond and scratch the crystal.

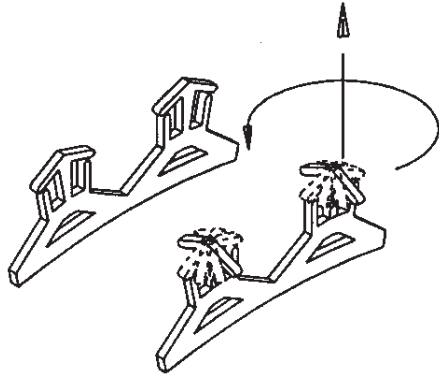

A Turn both tabs 90° counterclockwise on either side of pocket where the octagon should be.

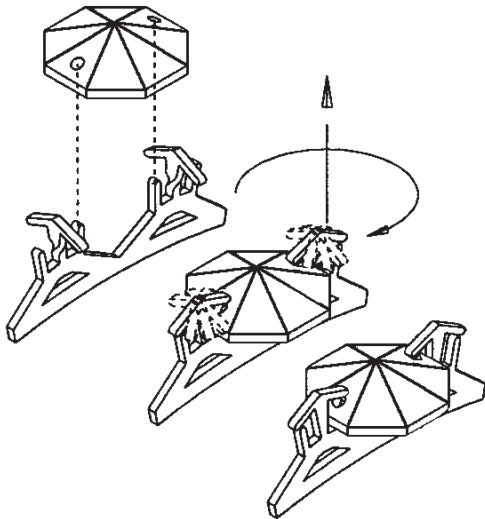

B Slide crystal octagon into pocket. Turn both tabs clockwise back to original position to hold the octagon in place.

CRYSTAL IDENTIFICATION SHEET

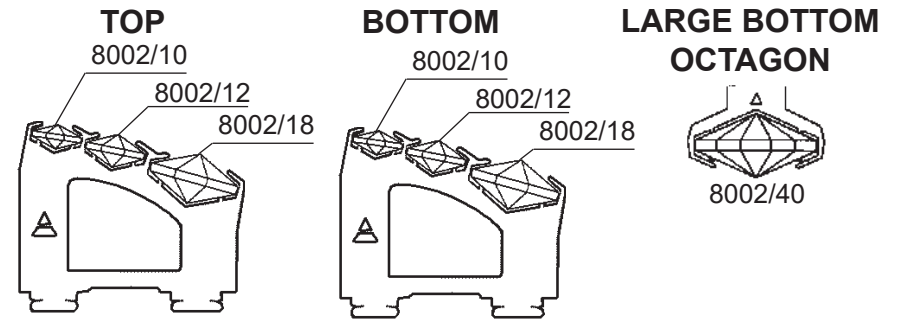

CRYSTAL SECTIONS

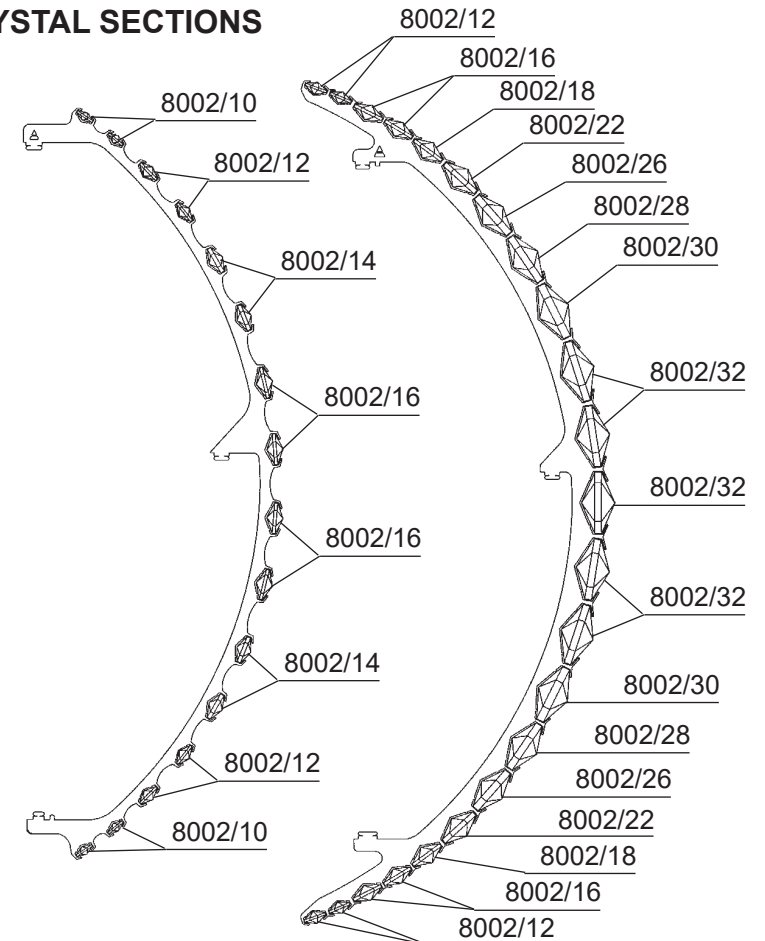

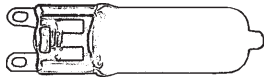

18 - G9 JCD
40 Watts Max
Hanging Weight: 33 pounds
Install bulbs and be sure to test
fixture BEFORE assembly.



To avoid damaging, do
NOT touch bulb with bare
hands. Install bulb with
clean cloth or tissue.

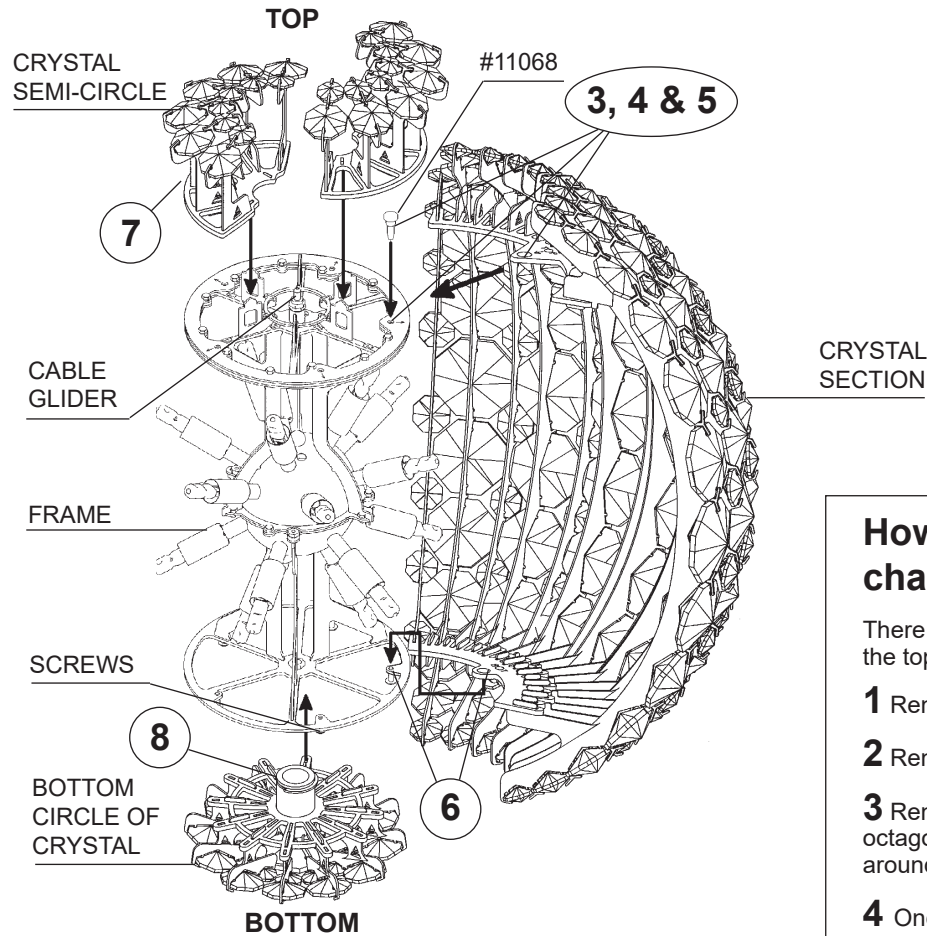

**TWO PERSON
ASSEMBLY
RECOMMENDED**

How to take apart your Da Vinci for changing bulbs or washing:

There are two crystal semi-circles surrounding the cable at the top.

- 1** Remove first semi-circle.
- 2** Remove second semi-circle.
- 3** Remove bottom by unscrewing large bottom crystal octagon. (You may push up on the area immediately around the octagon to reach it better.)
- 4** Once the bottom crystal is completely unscrewed, remove the entire bottom circle of crystal. Da Vinci comes apart like an orange, in five sections.
- 5** Locate and remove screws on the bottom of the ball. Do NOT discard screws, they are required for reassembly.
- 6** Locate the locking pin inside the top of the ball.
- 7** While holding one section of the ball, remove the pin by pulling it up. The crystal section can then be removed.
- 8** Remove the other four crystal sections in the same manner, so that all that remains is the frame with bulbs.
- 9** Replace necessary bulbs.

If you are cleaning your Da Vinci, all crystal parts can now be placed in the dishwasher.

See page 7 for cleaning instructions

How to Assemble Your Da Vinci Chandelier:

Put on white cotton gloves to handle crystal.

- 3** Align arrows at top of one crystal section of the sphere (labeled "TOP").
- 4** Slide guide tab into slot to line up holes for locking pin.
- 5** To secure the crystal section, slide pin into hole. Push pin in until it seats.
HOLD ON SECURELY TO CRYSTAL SECTION UNTIL YOU ARE SURE PIN IS ENGAGED.
- 6** Align holes on the bottom of crystal section with the screw on the bottom of the frame (labeled "BOT"). Tighten screw. Repeat steps 3 - 6 with other four crystal sections.
- 7** Assemble top by dropping in the crystal semi-circles one at a time.
- 8** Assemble bottom by screwing in large bottom octagon. (You may push up on the area immediately around the octagon to reach it better.)