

# PRISCILLA BC7110N-\_\_ \_\_O

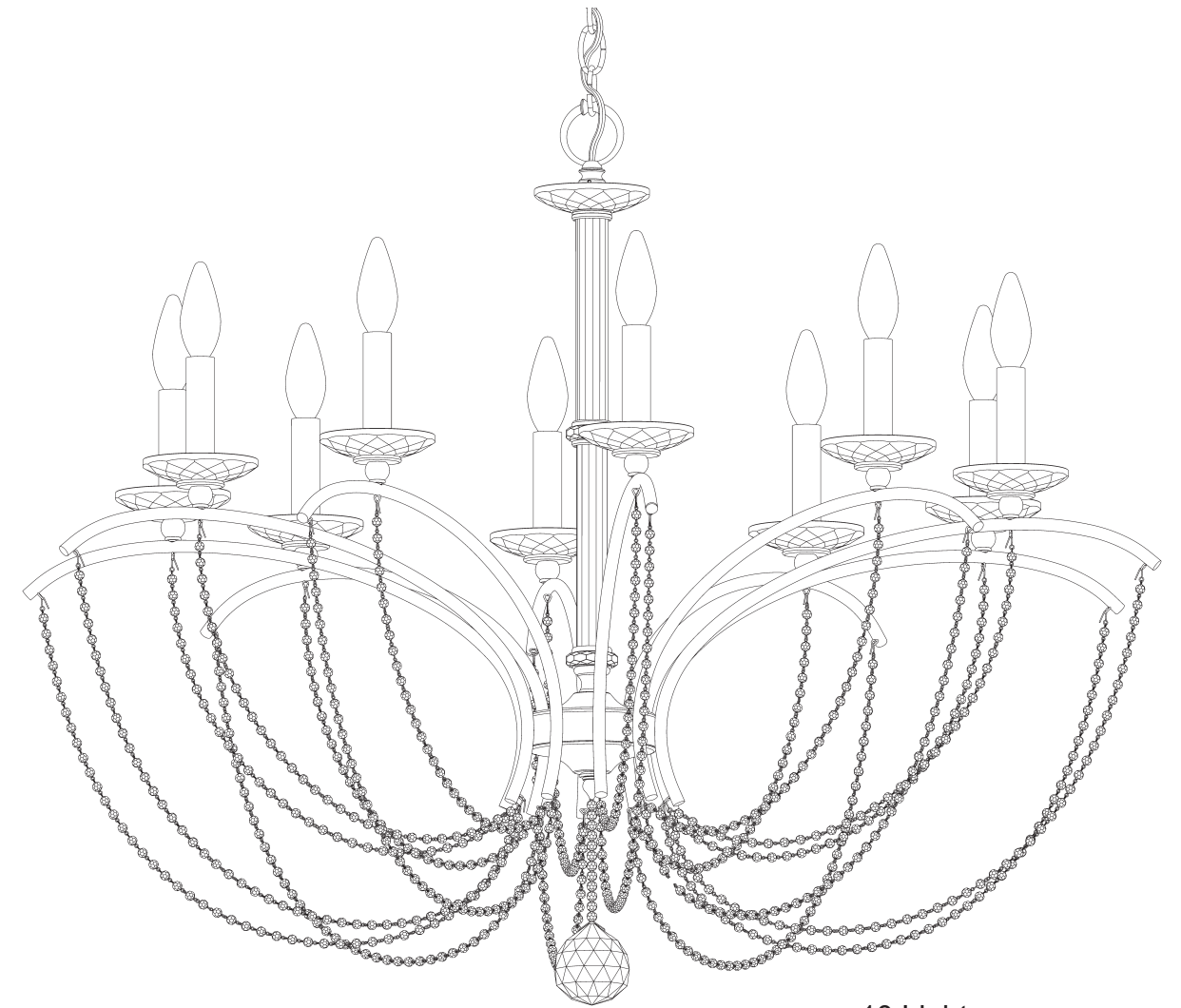











10 Lights  
Diameter: 36"  
Height: 28"  
Hanging Weight: 16lbs.

**T**HIS DESIGN IS THE PROPRIETARY  
TRADE DRESS/TRADEMARK OF  
W SCHONBEK LLC.

 **SCHONBEK** | 1870

 **SCHONBEK** | 1870

								
MAX <u>60</u> W		110-120 V						

**WARNING:**

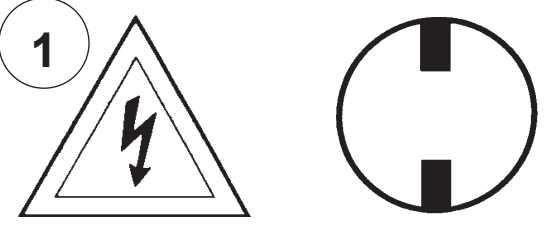
1 

**Electrical Danger Turn Power Off**

All electrical components must be installed by a licensed electrician in accordance with the National Electric Code and the appropriate local electrical codes.

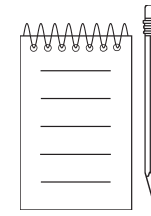
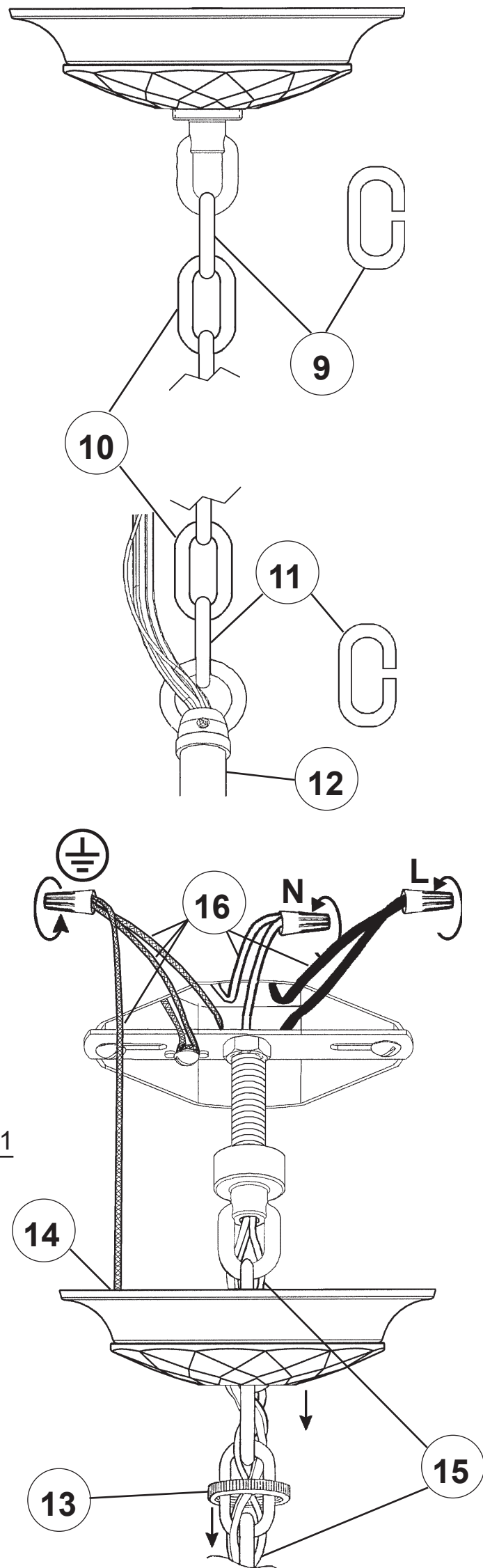
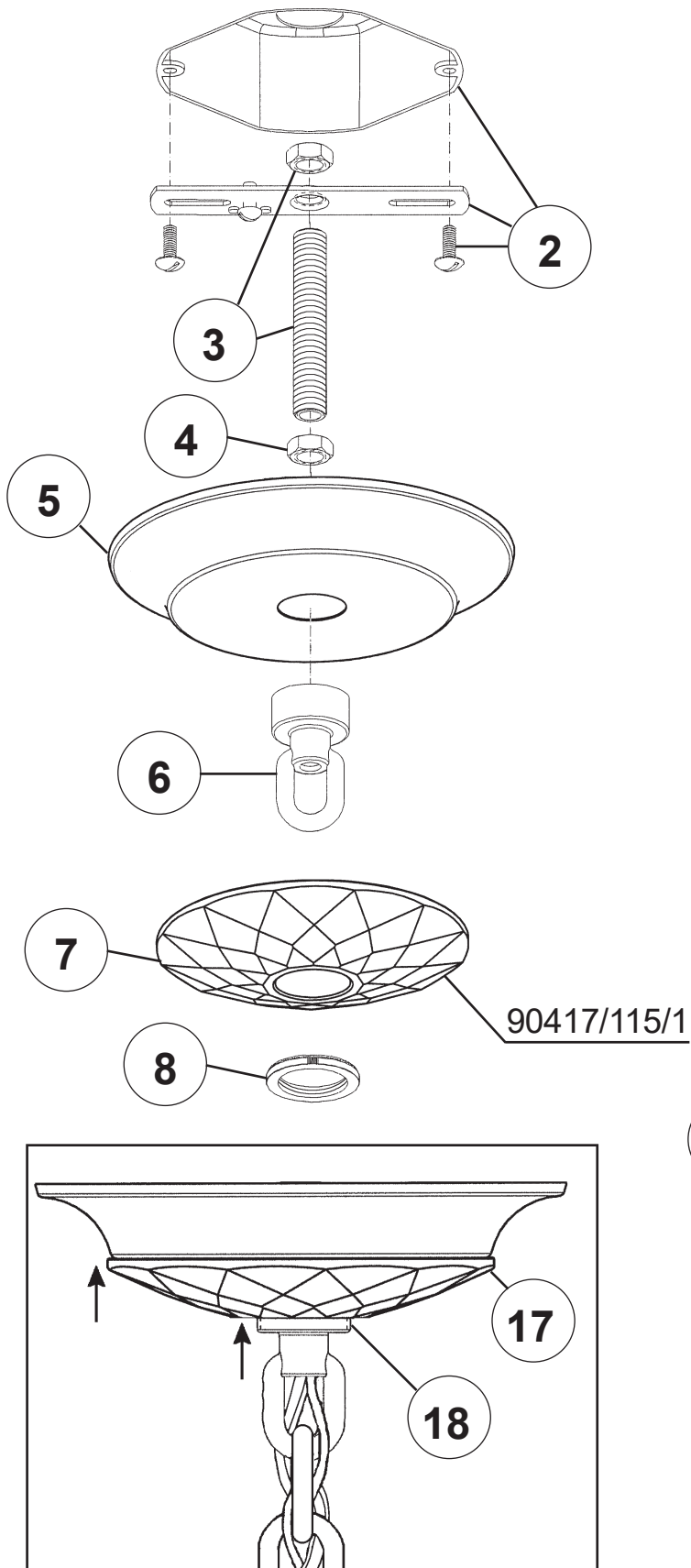

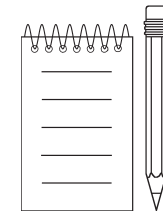

19



You will need 10 - B10  
60 Watts Max

Install bulbs and be sure to  
test fixture BEFORE  
trimming.

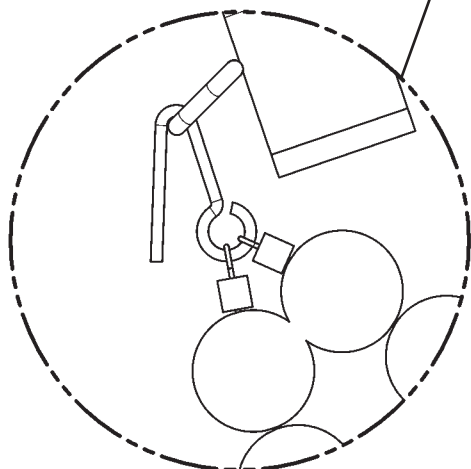
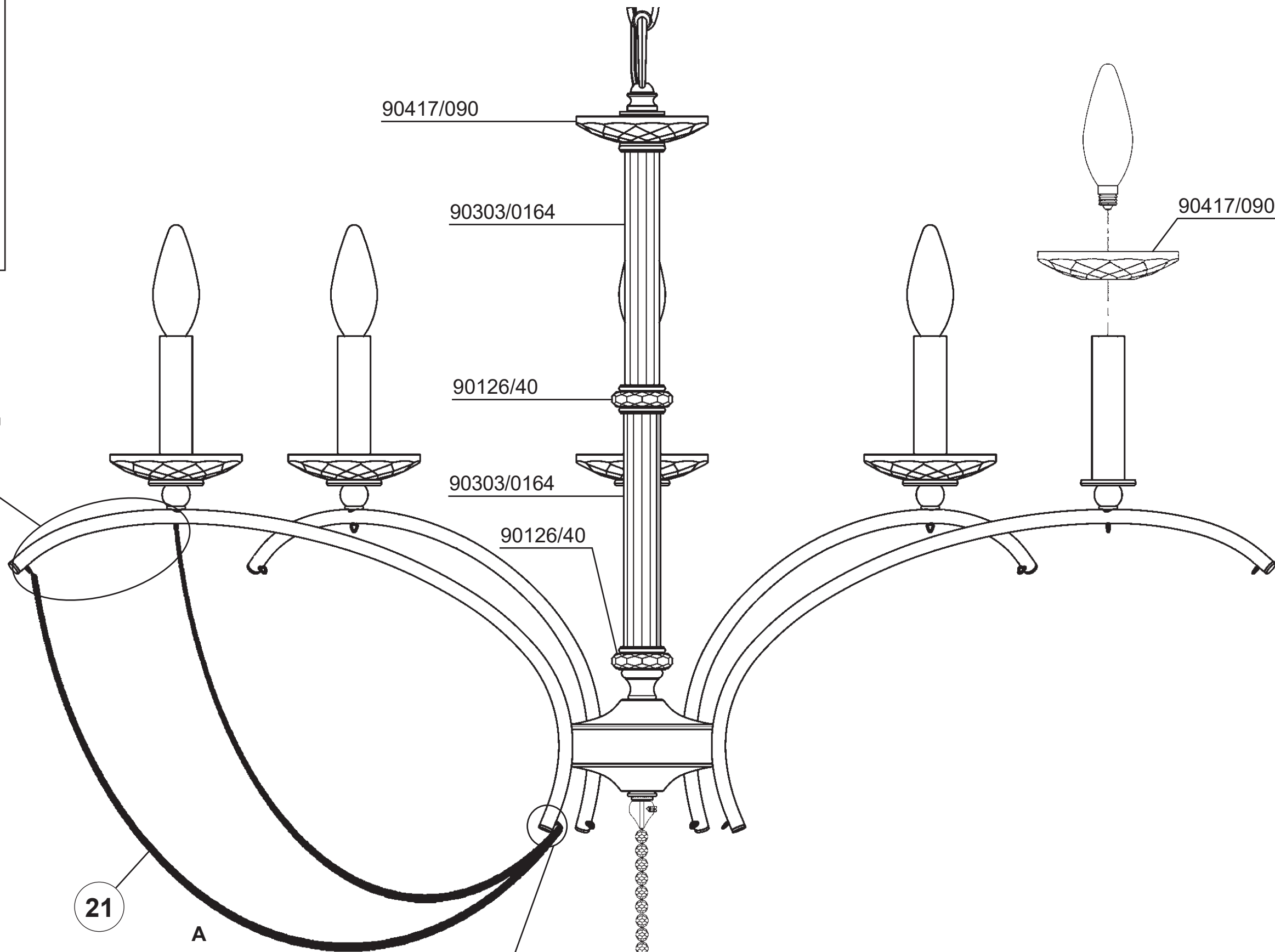
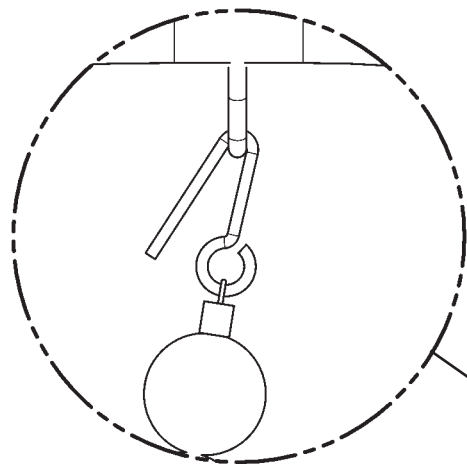

N20876-\*\*

20

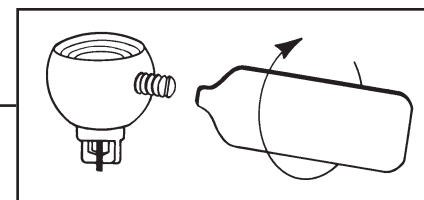

# PRISCILLA BC7110N- \_\_ \_\_ P \_\_ \_\_













10 Lights  
Diameter: 36"  
Height: 28"  
Hanging Weight: 16lbs.

**T**HIS DESIGN IS THE PROPRIETARY  
TRADE DRESS/TRADEMARK OF  
W SCHONBEK LLC.

 **SCHONBEK** | 1870

 **SCHONBEK** | 1870

								
MAX <u>60</u> W		110-120 V						

**WARNING:**

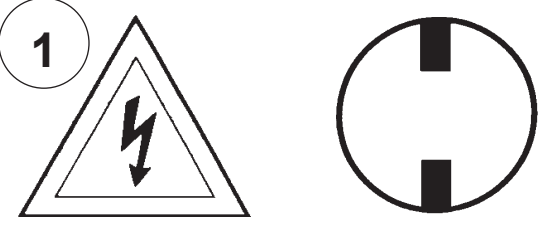
1 

**Electrical Danger Turn Power Off**

All electrical components must be installed by a licensed electrician in accordance with the National Electric Code and the appropriate local electrical codes.

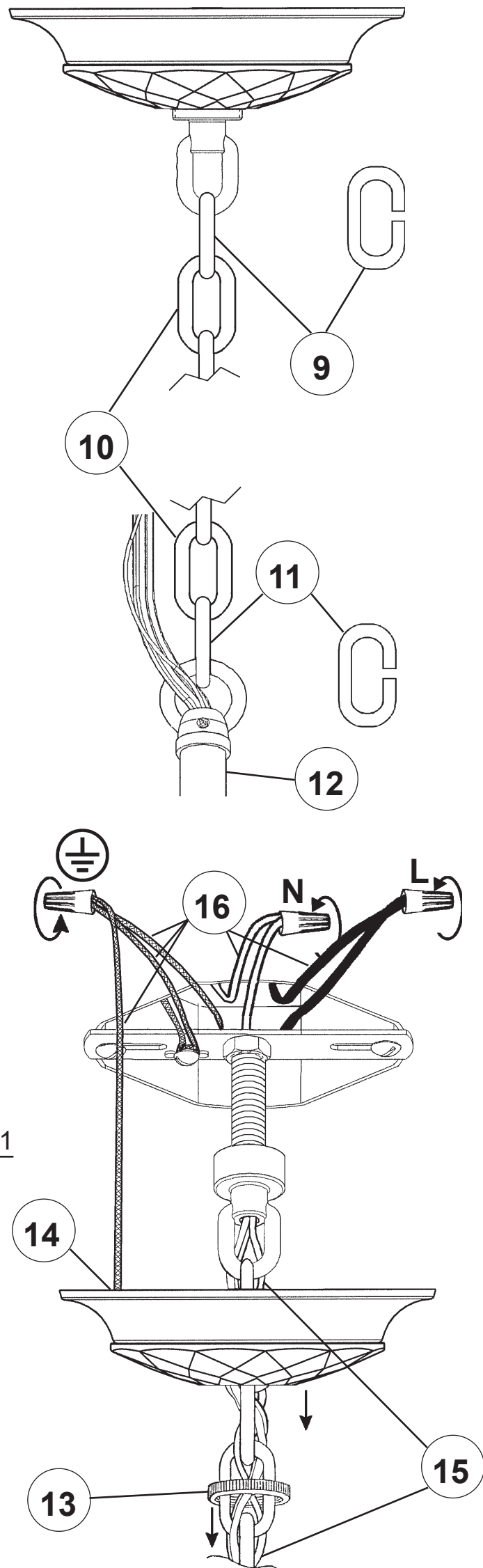
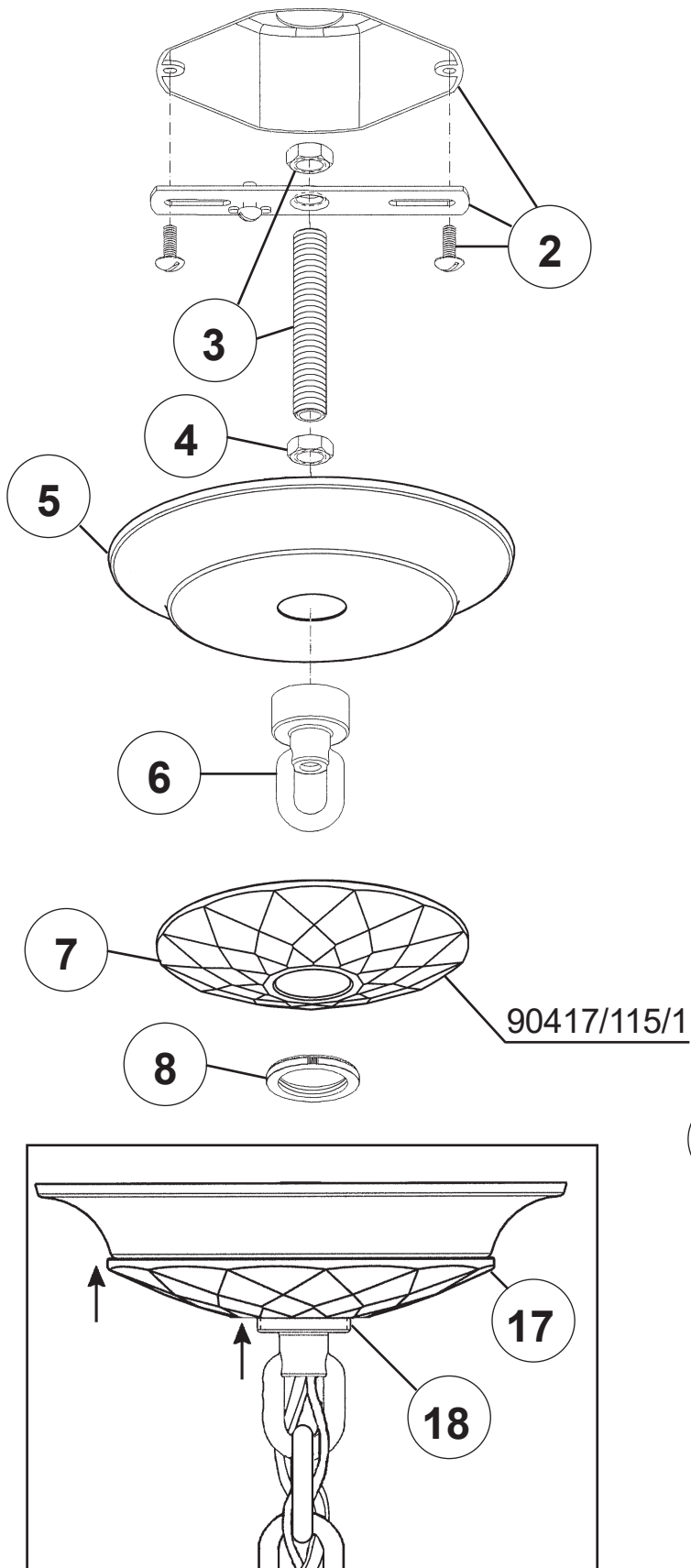

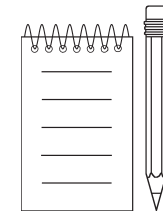
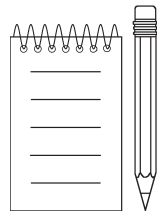

19

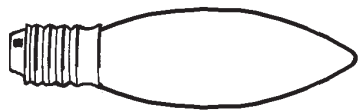

You will need 10 - B10  
60 Watts Max

Install bulbs and be sure to  
test fixture BEFORE  
trimming.

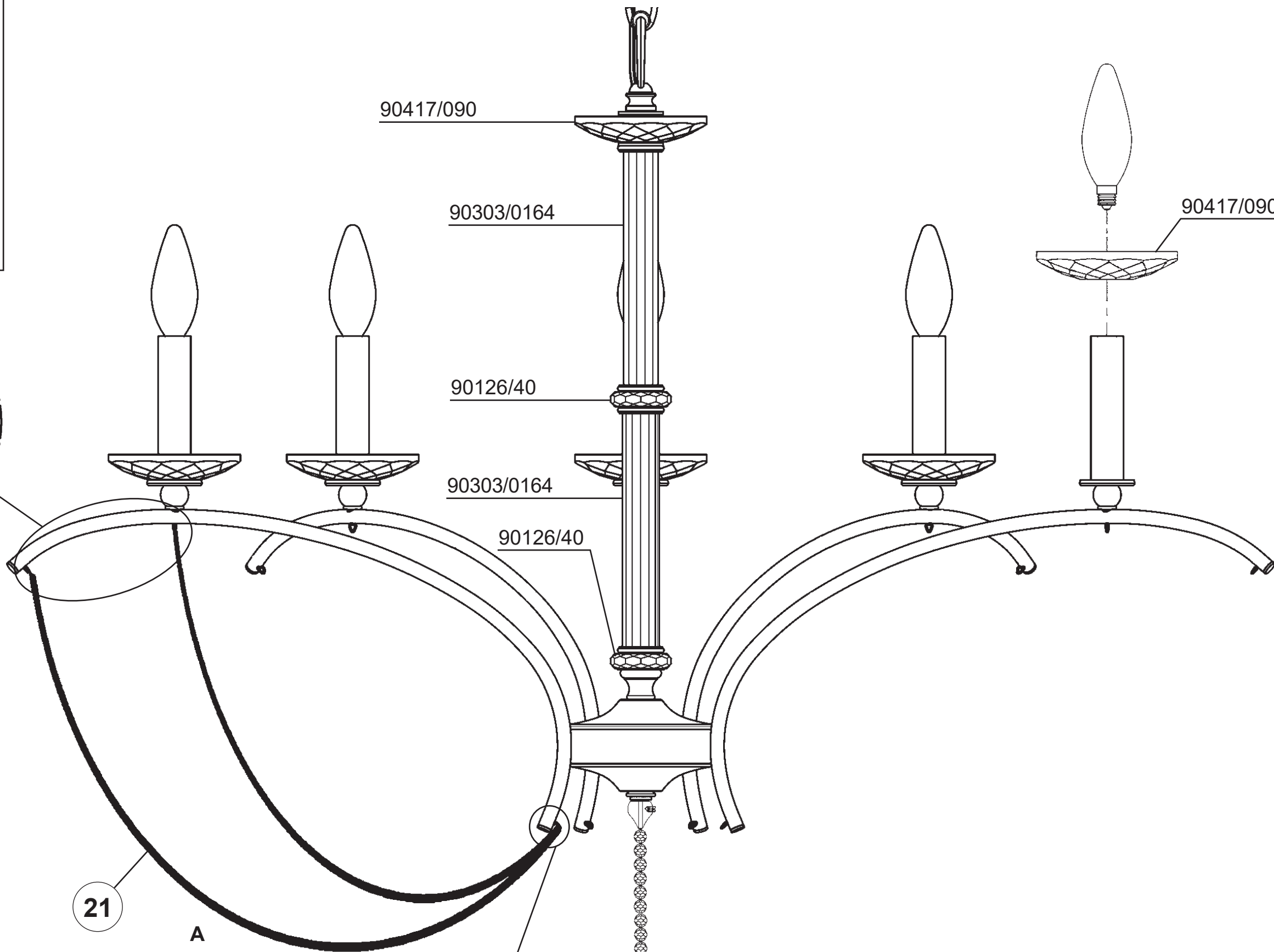
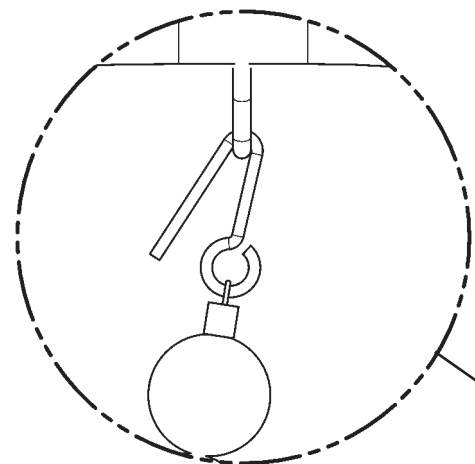

21

A

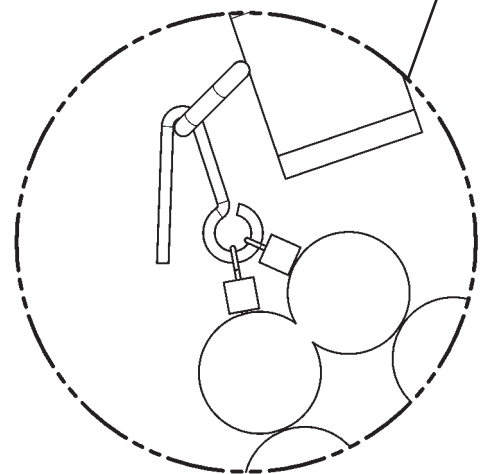

N20876-\*\*

20

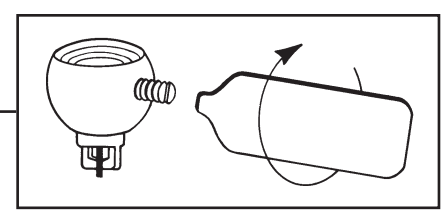



PRISCILLA BC7110N- \_\_ \_\_ P \_\_ \_\_













10 Lights  
Diameter: 36"  
Height: 28"  
Hanging Weight: 16lbs.

**T**HIS DESIGN IS THE PROPRIETARY  
TRADE DRESS/TRADEMARK OF  
W SCHONBEK LLC.

 **SCHONBEK** | 1870

 **SCHONBEK** | 1870

								
MAX <u>60</u> W	110-120 V							

**WARNING:**

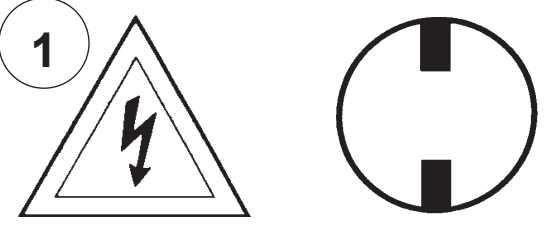

**1**

**Electrical Danger Turn Power Off**

All electrical components must be installed by a licensed electrician in accordance with the National Electric Code and the appropriate local electrical codes.

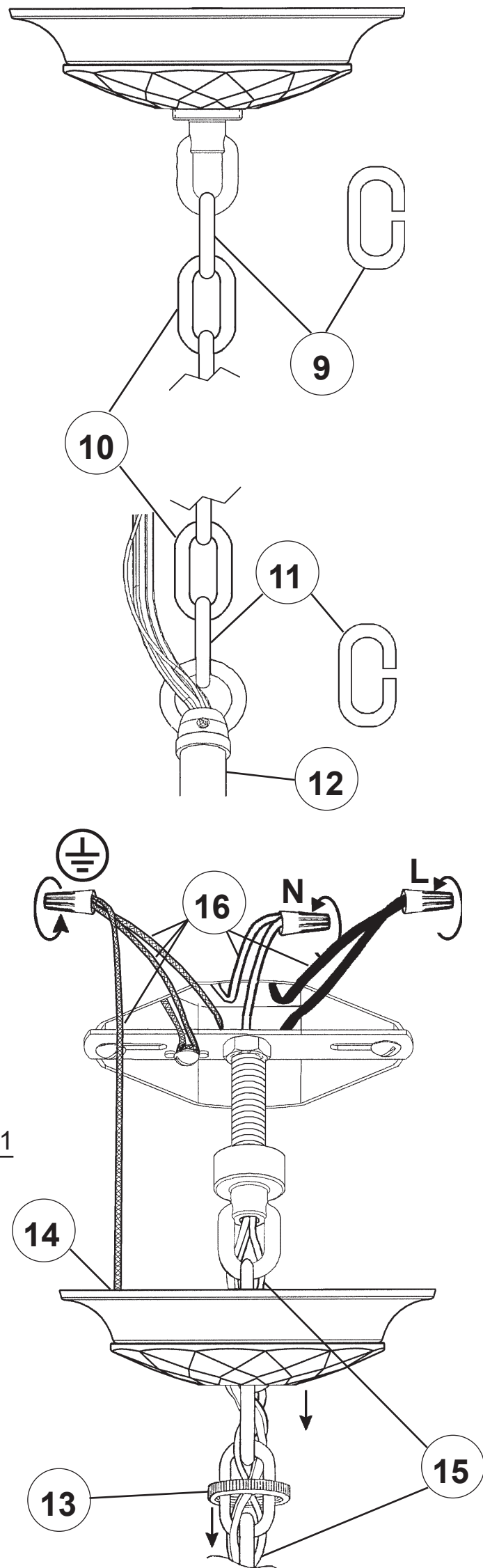
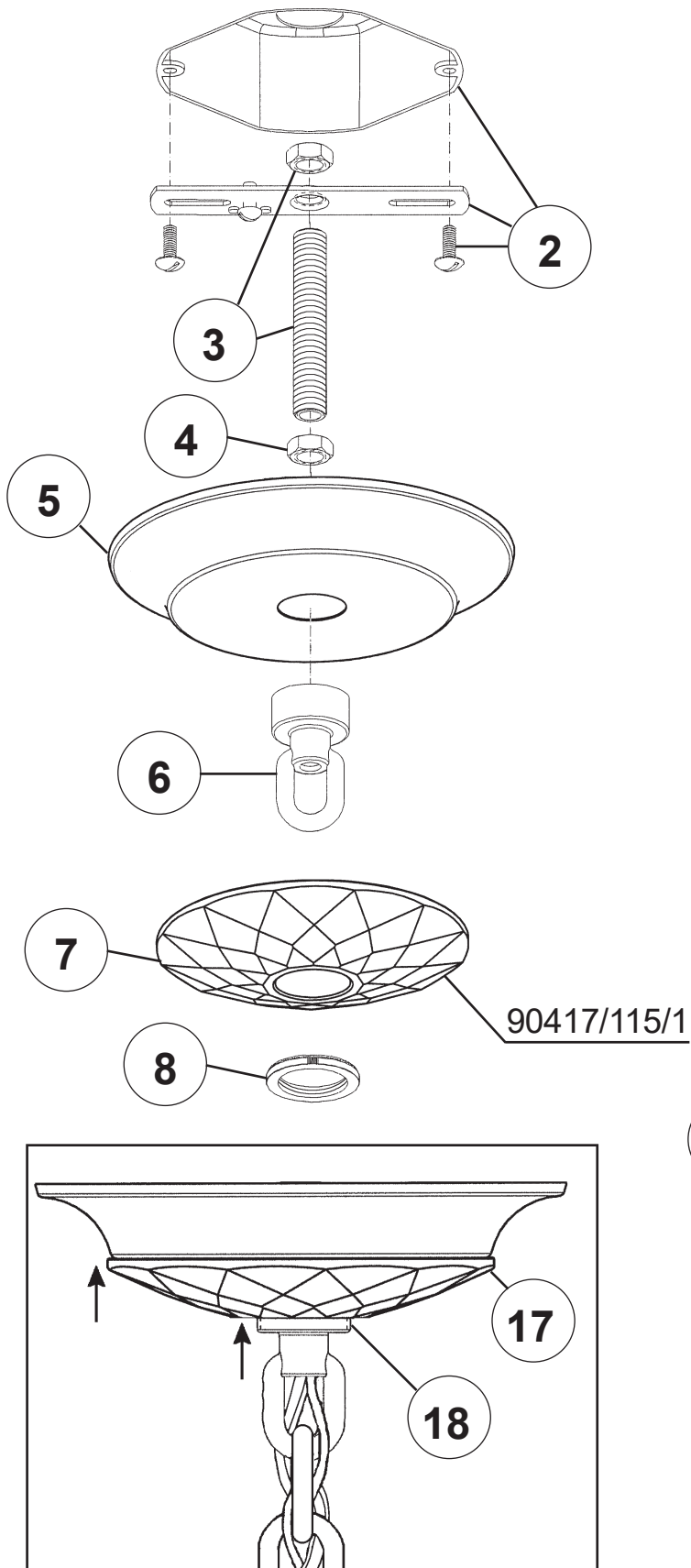

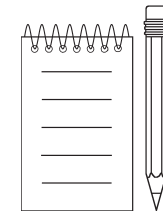

19



You will need 10 - B10  
60 Watts Max

Install bulbs and be sure to  
test fixture BEFORE  
trimming.

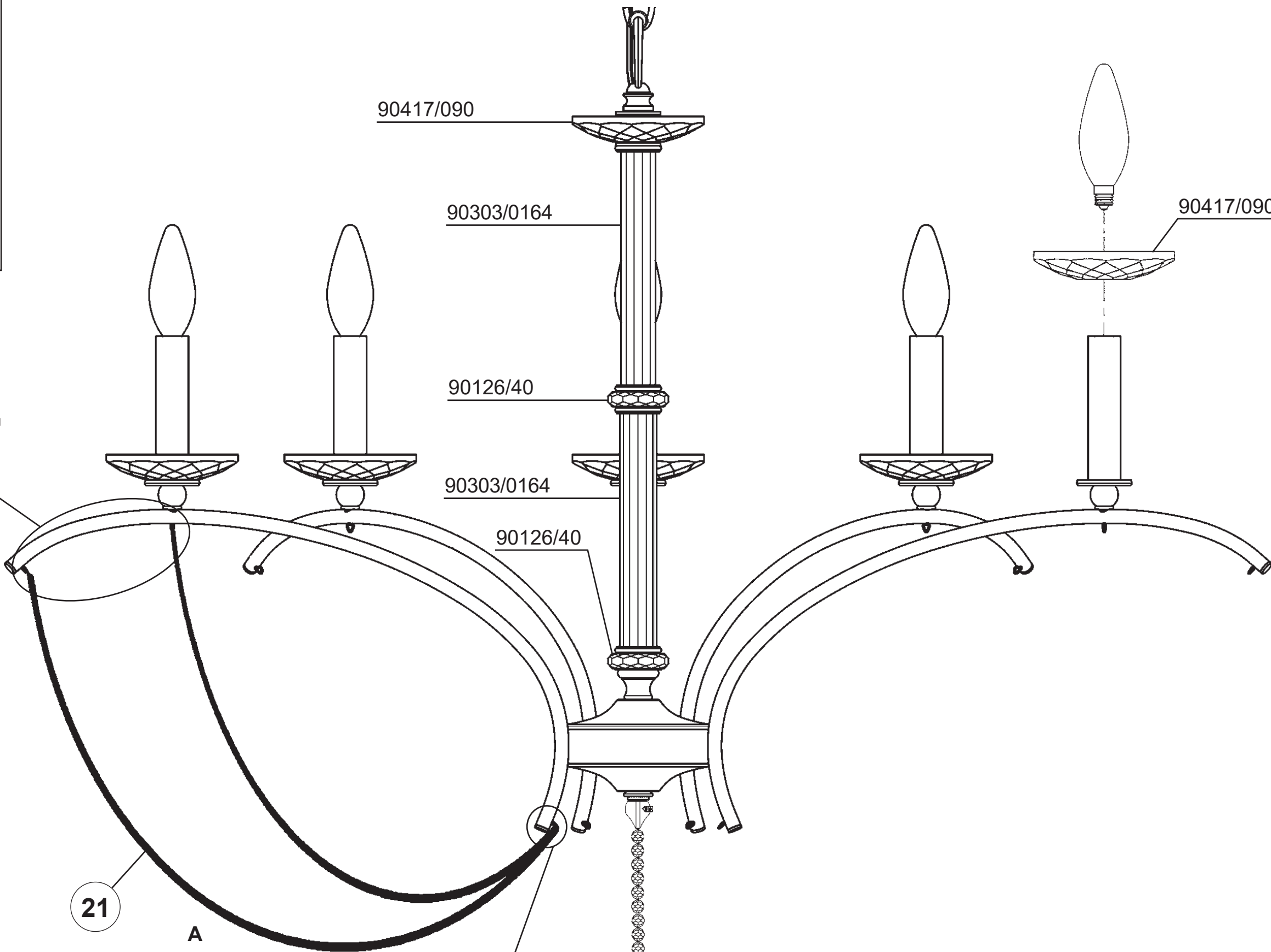
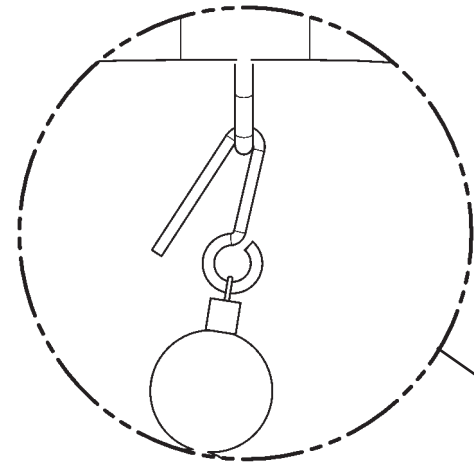

21

A

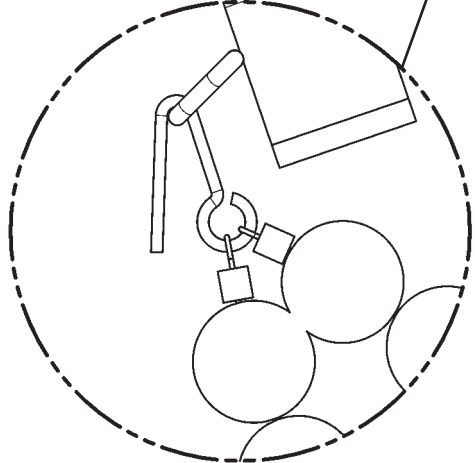

N20876-\*\*

20

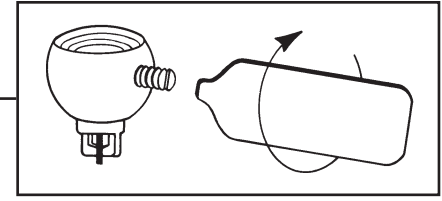

# PRISCILLA BC7110N- \_\_ \_\_ P \_\_ \_\_













10 Lights  
Diameter: 36"  
Height: 28"  
Hanging Weight: 16lbs.

**T**HIS DESIGN IS THE PROPRIETARY  
TRADE DRESS/TRADEMARK OF  
W SCHONBEK LLC.

 **SCHONBEK** | 1870

 **SCHONBEK** | 1870

								
MAX <u>60</u> W		110-120 V						

**WARNING:**

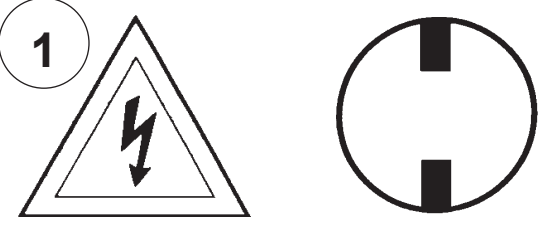
1 

**Electrical Danger Turn Power Off**

All electrical components must be installed by a licensed electrician in accordance with the National Electric Code and the appropriate local electrical codes.

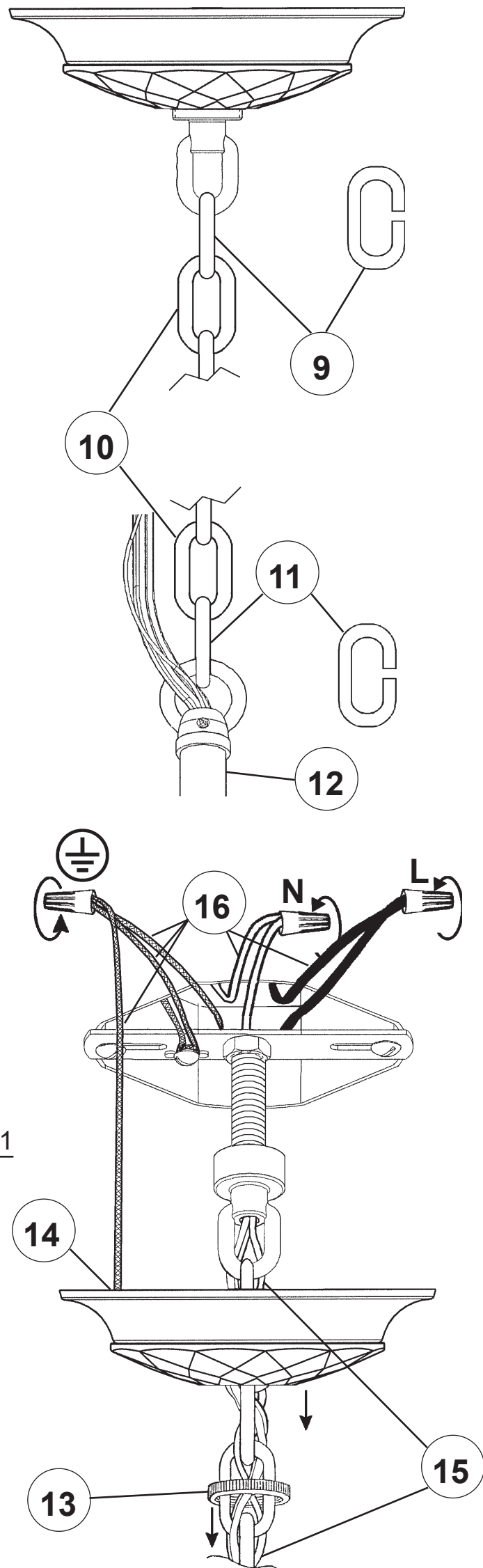
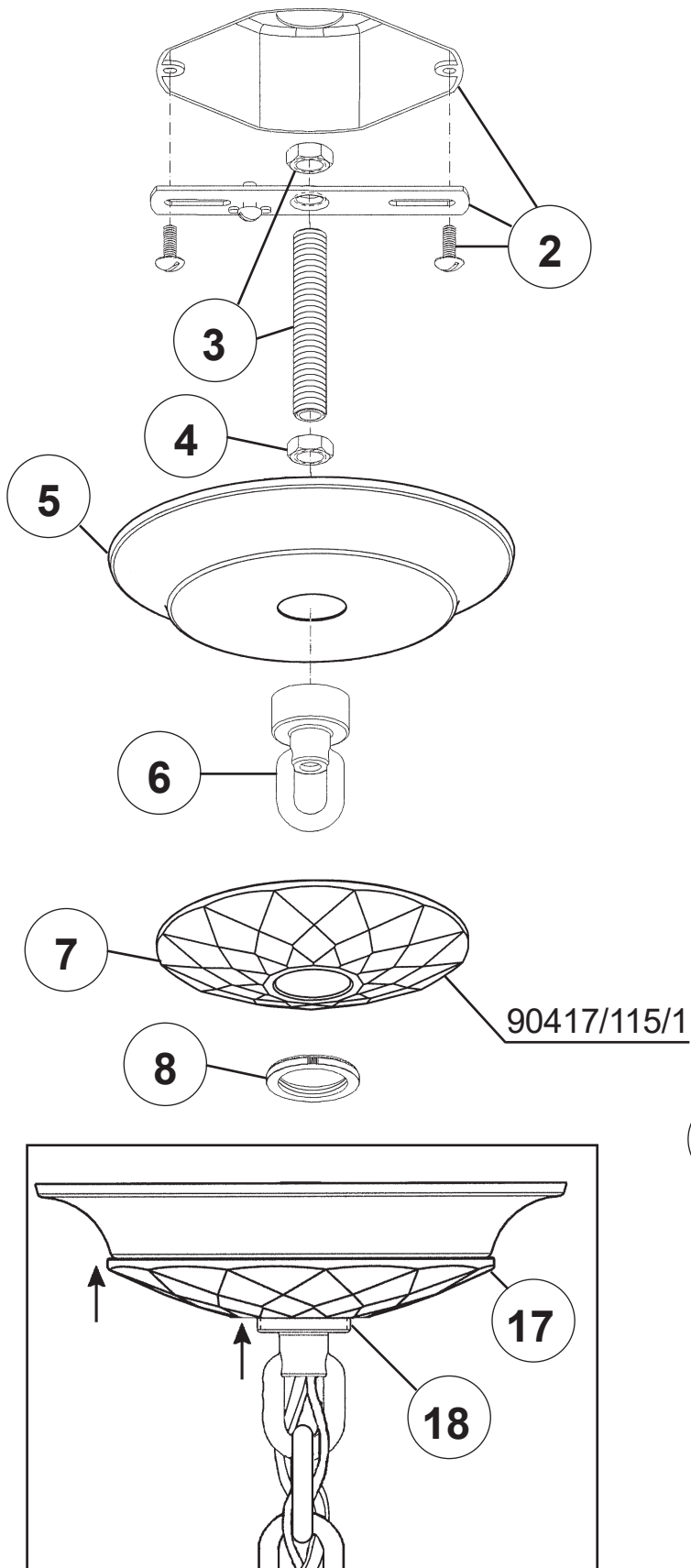

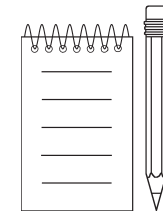
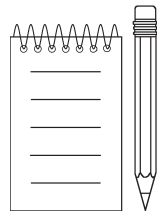

19



You will need 10 - B10  
60 Watts Max

Install bulbs and be sure to  
test fixture **BEFORE**  
trimming.

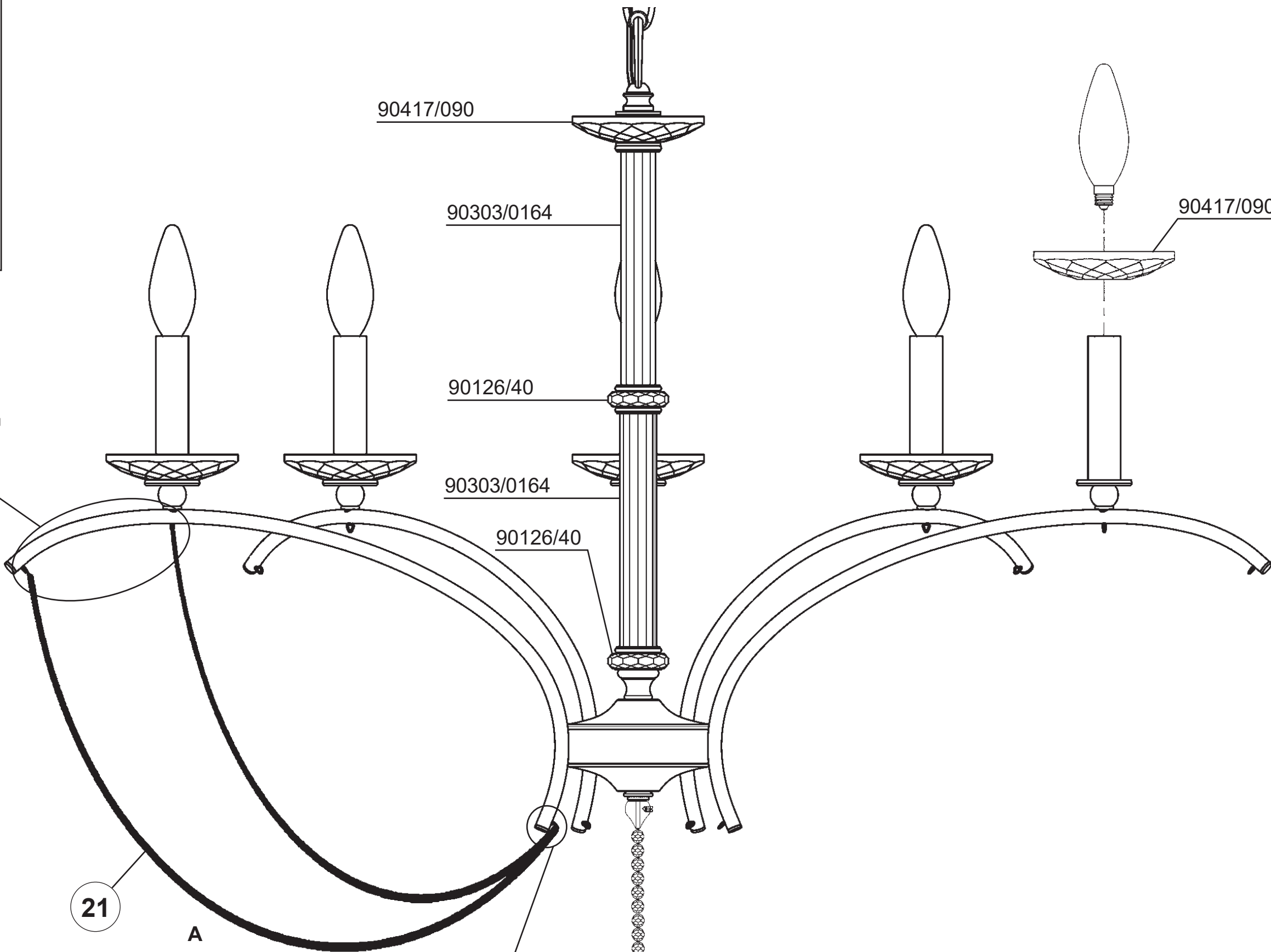
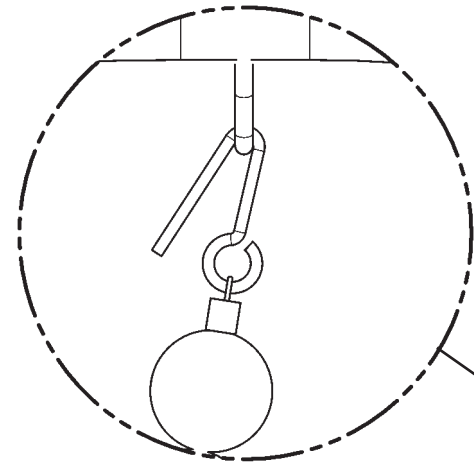

21

A

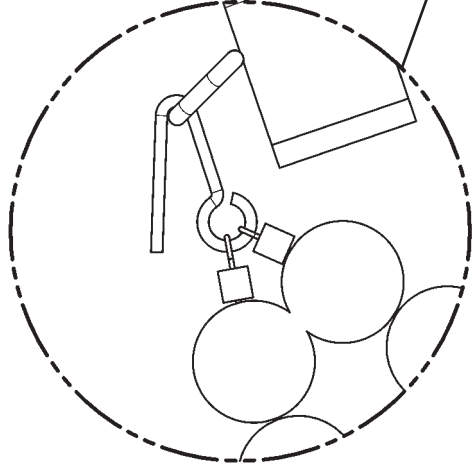

N20876-\*\*

20

