

ESMERY AR1002N-__ __O

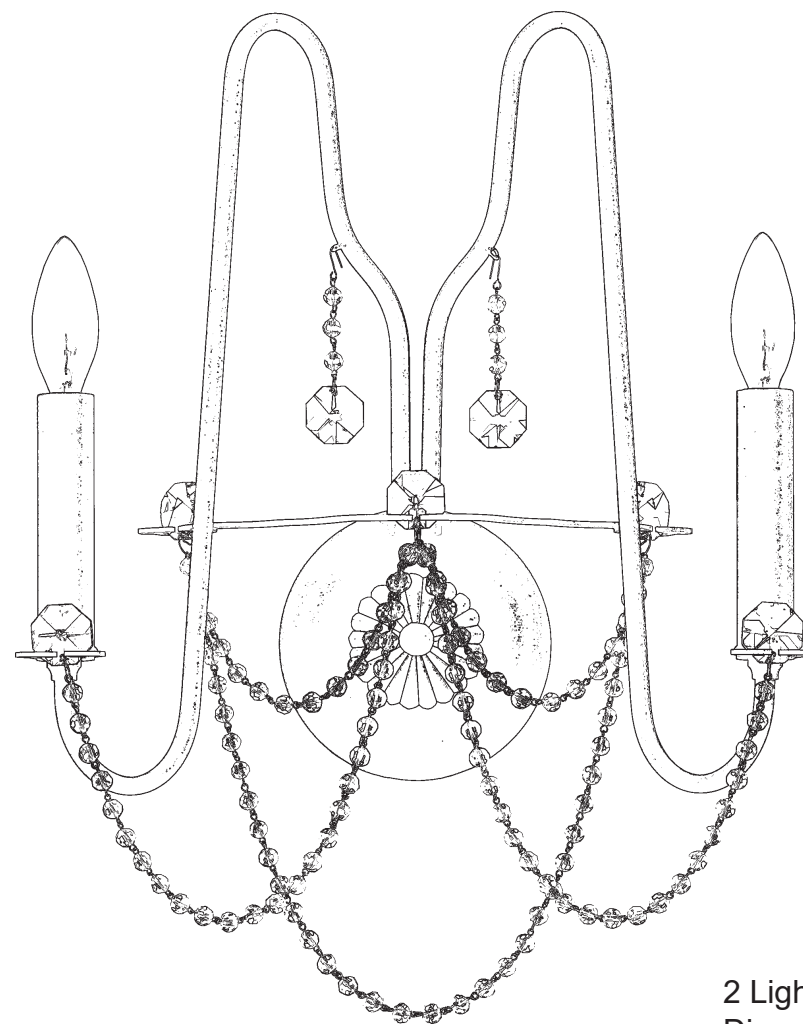











2 Lights
Diameter: 12-1/2"
Height: 16-1/2"
Extension: 7"
Hanging Weight: 2lbs.

THIS DESIGN IS THE PROPRIETARY
TRADE DRESS/TRADEMARK OF
W SCHONBEK LLC.

 **SCHONBEK** | 1870

 **SCHONBEK** | 1870

								
MAX <u>60</u> W	110-120 V							

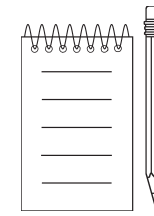
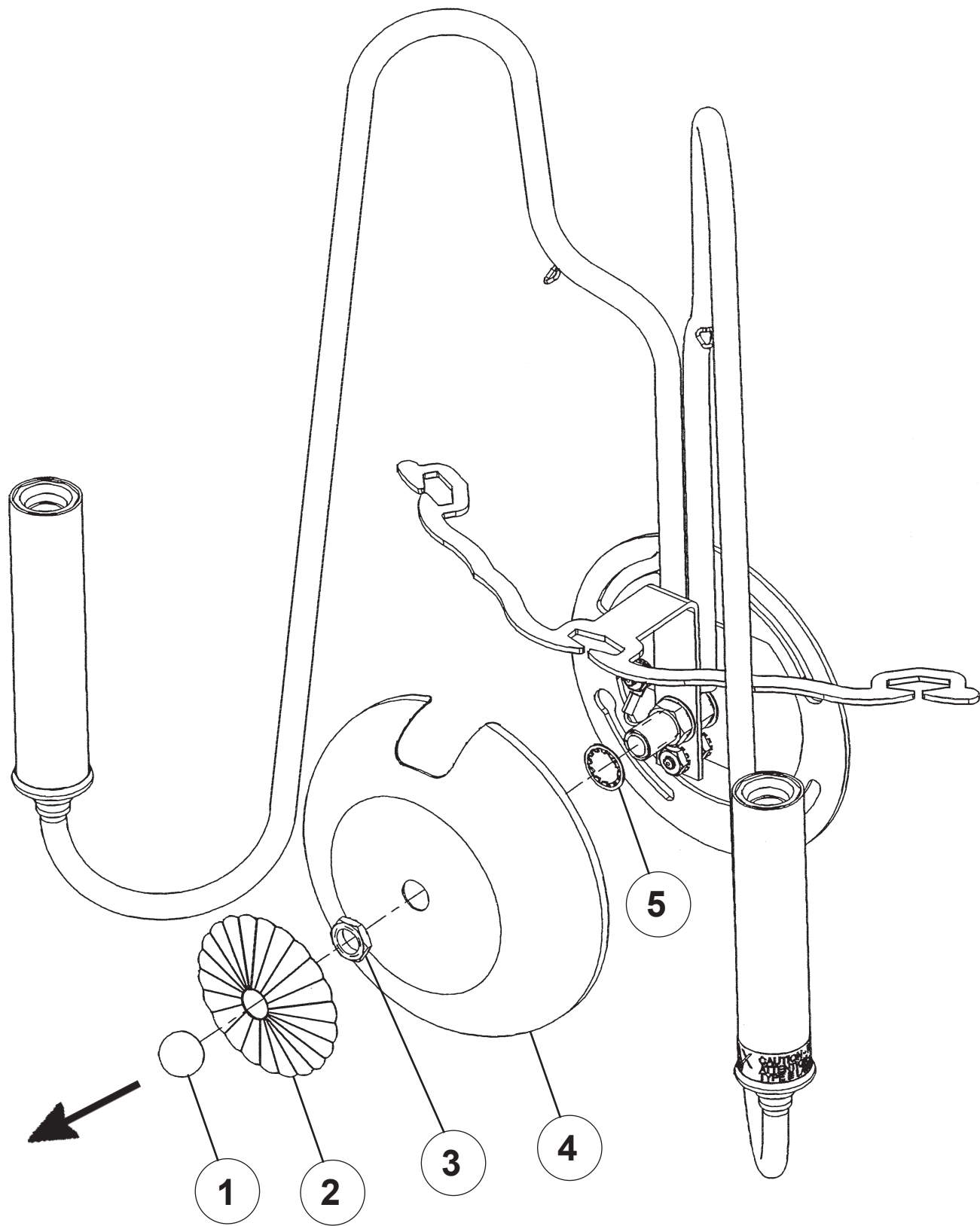

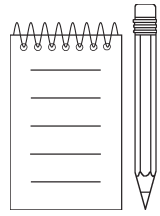

WARNING:

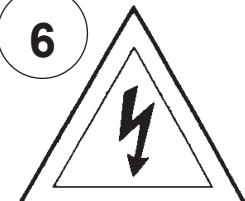
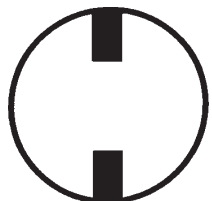
6  

Electrical Danger Turn Power Off

All electrical components must be installed by a licensed electrician in accordance with the National Electric Code and the appropriate local electrical codes.

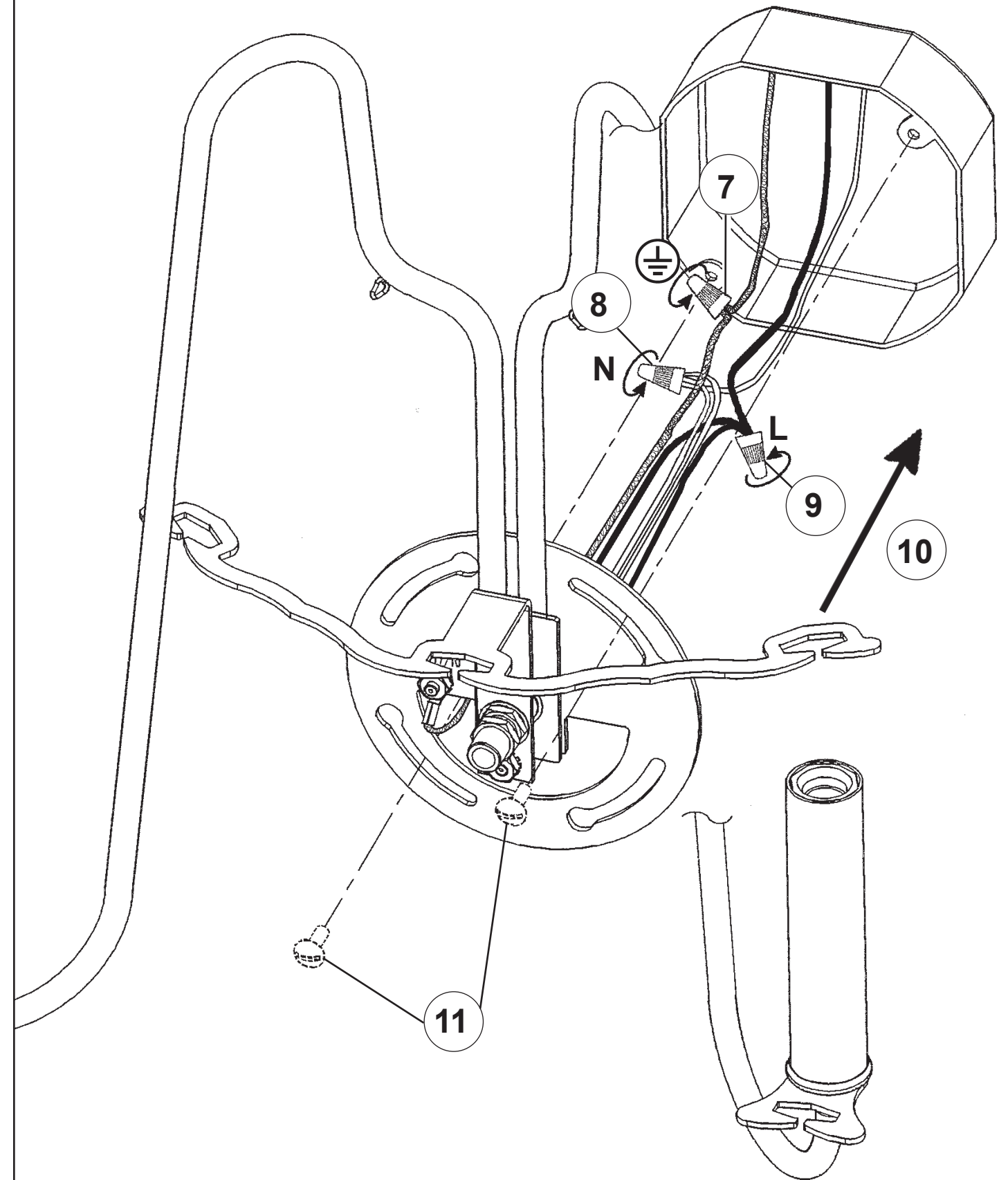

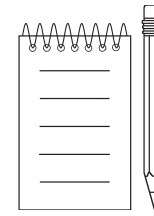
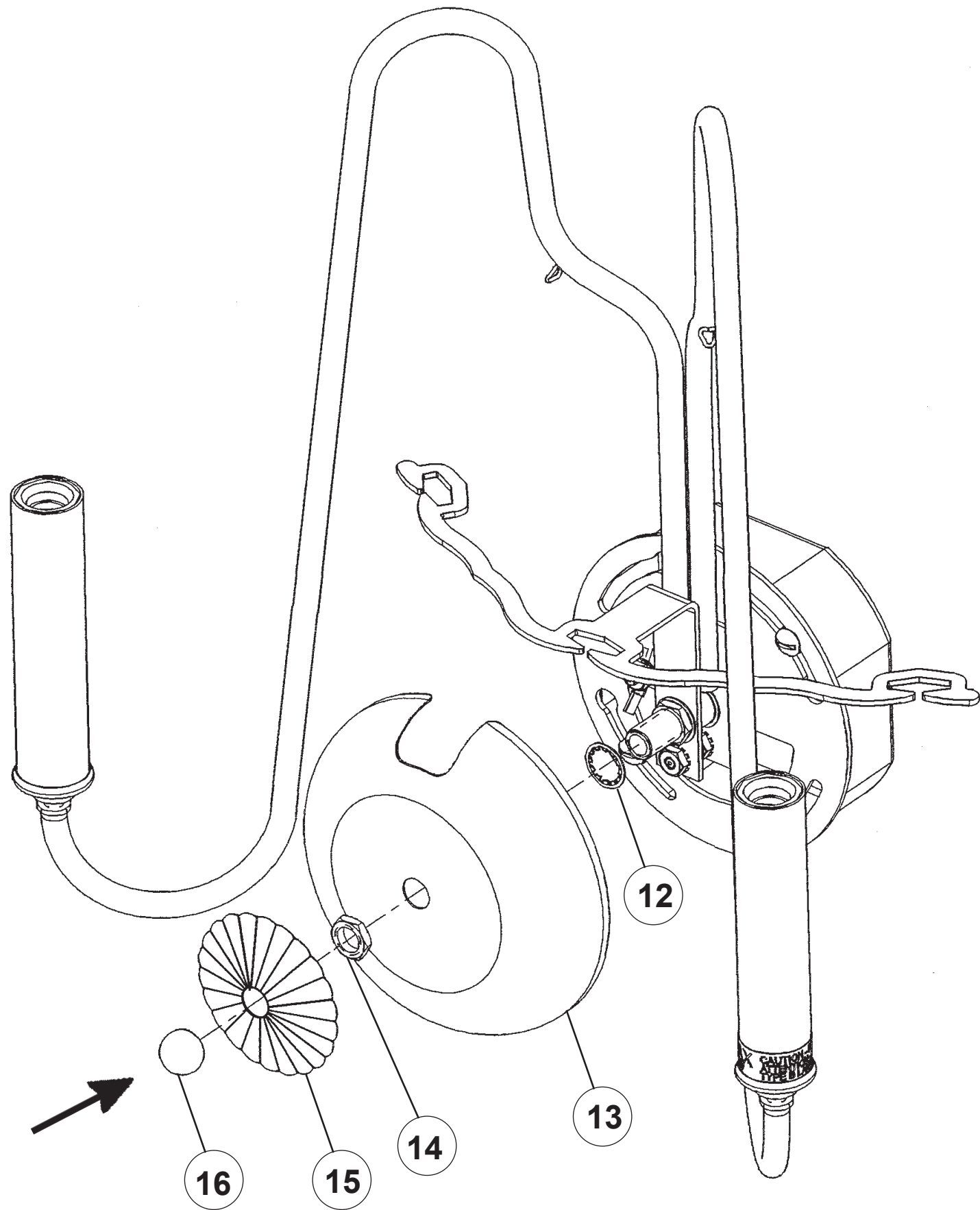

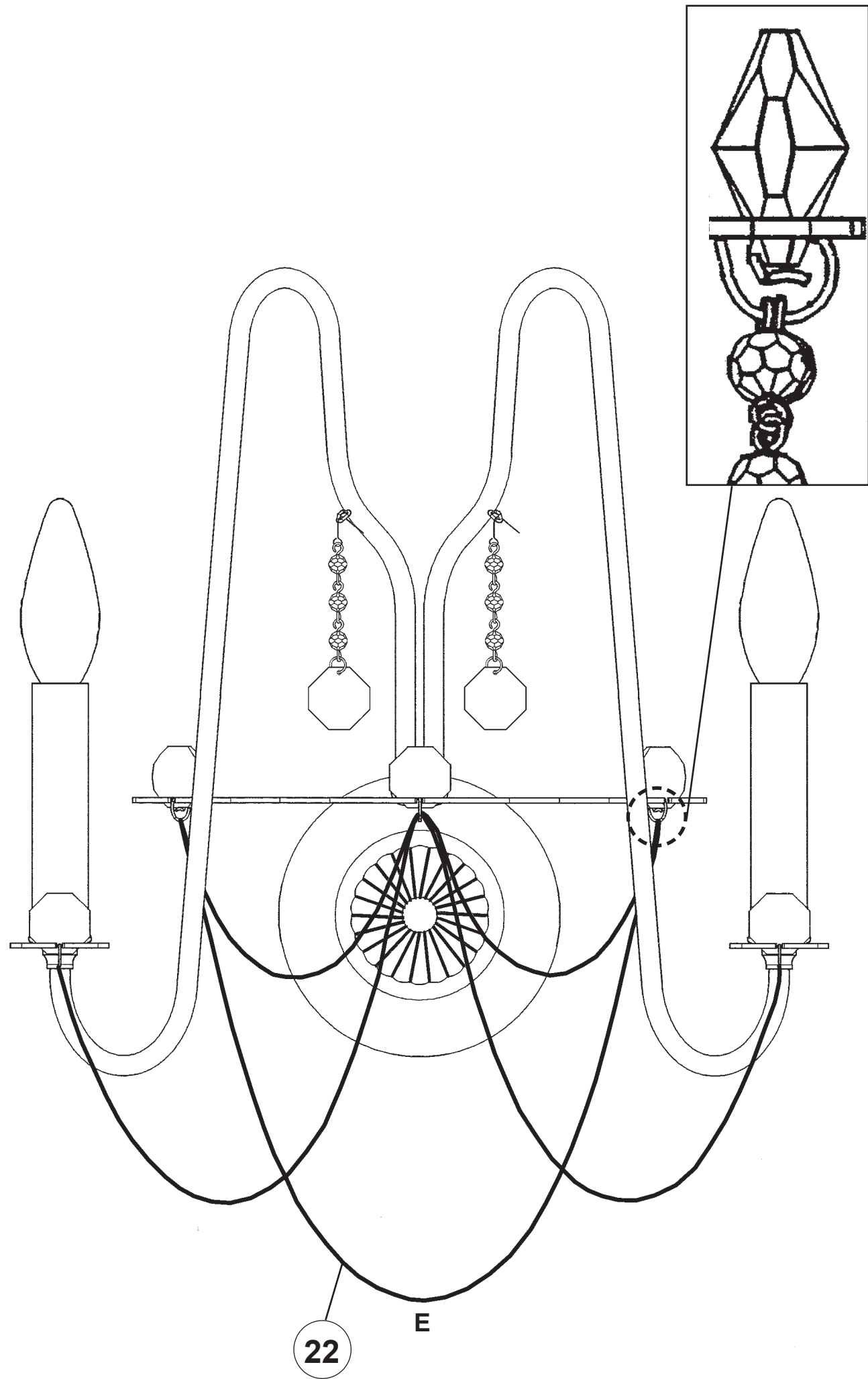

17

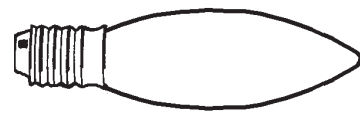

You will need 2 - B10
25 Watts Recommended
60 Watts Max

Install bulbs and be sure
to test fixture **BEFORE**
trimming.

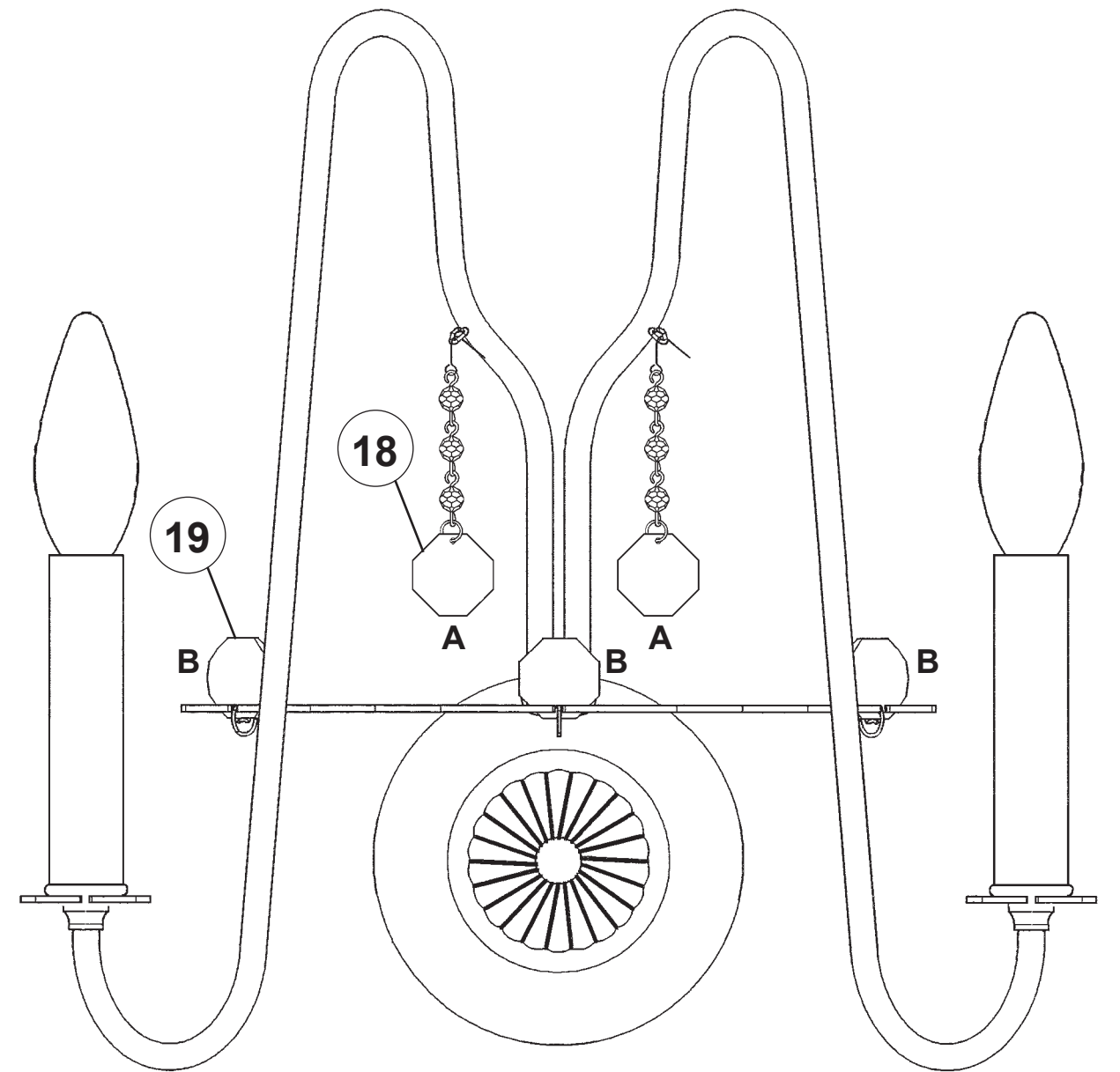

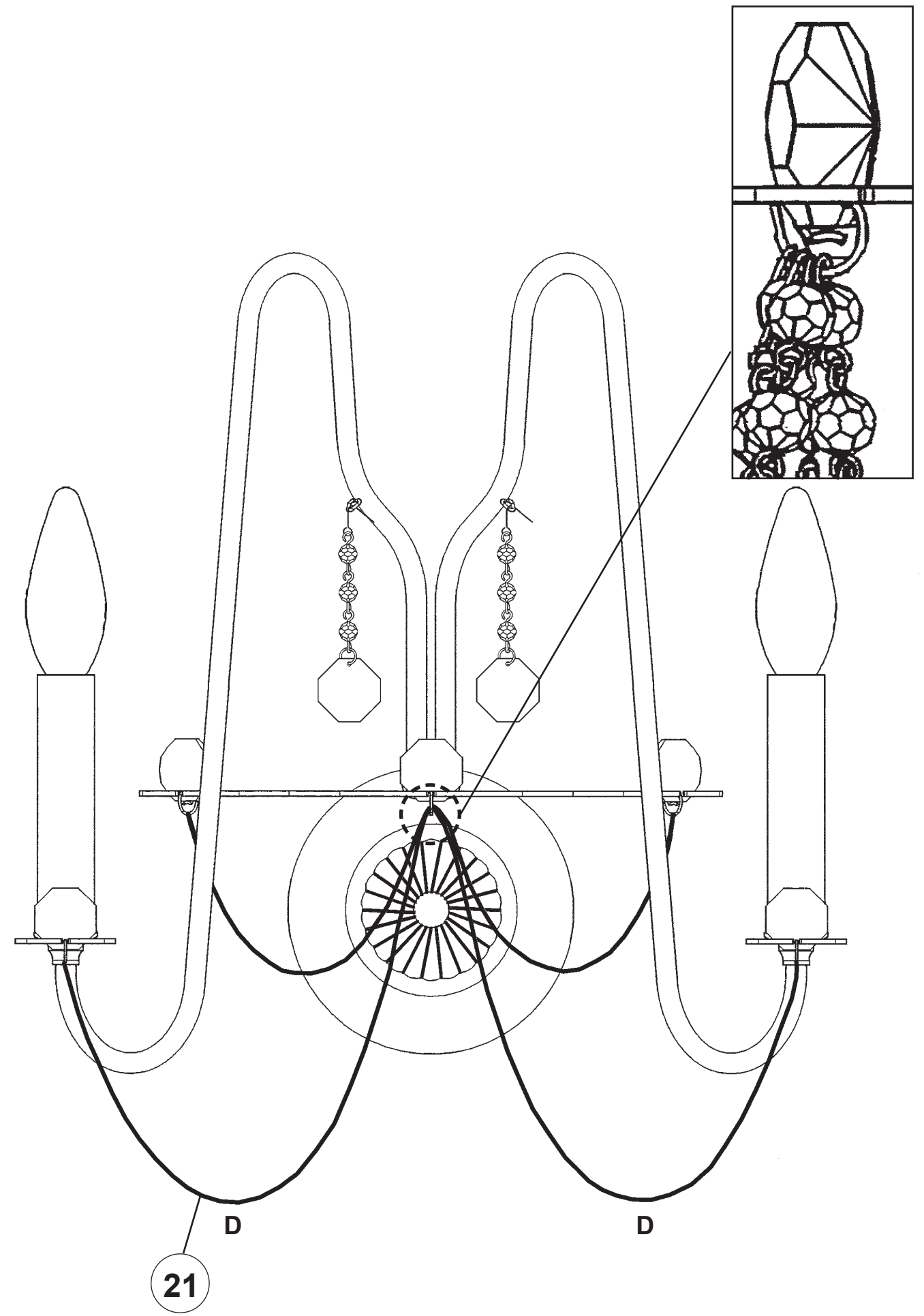
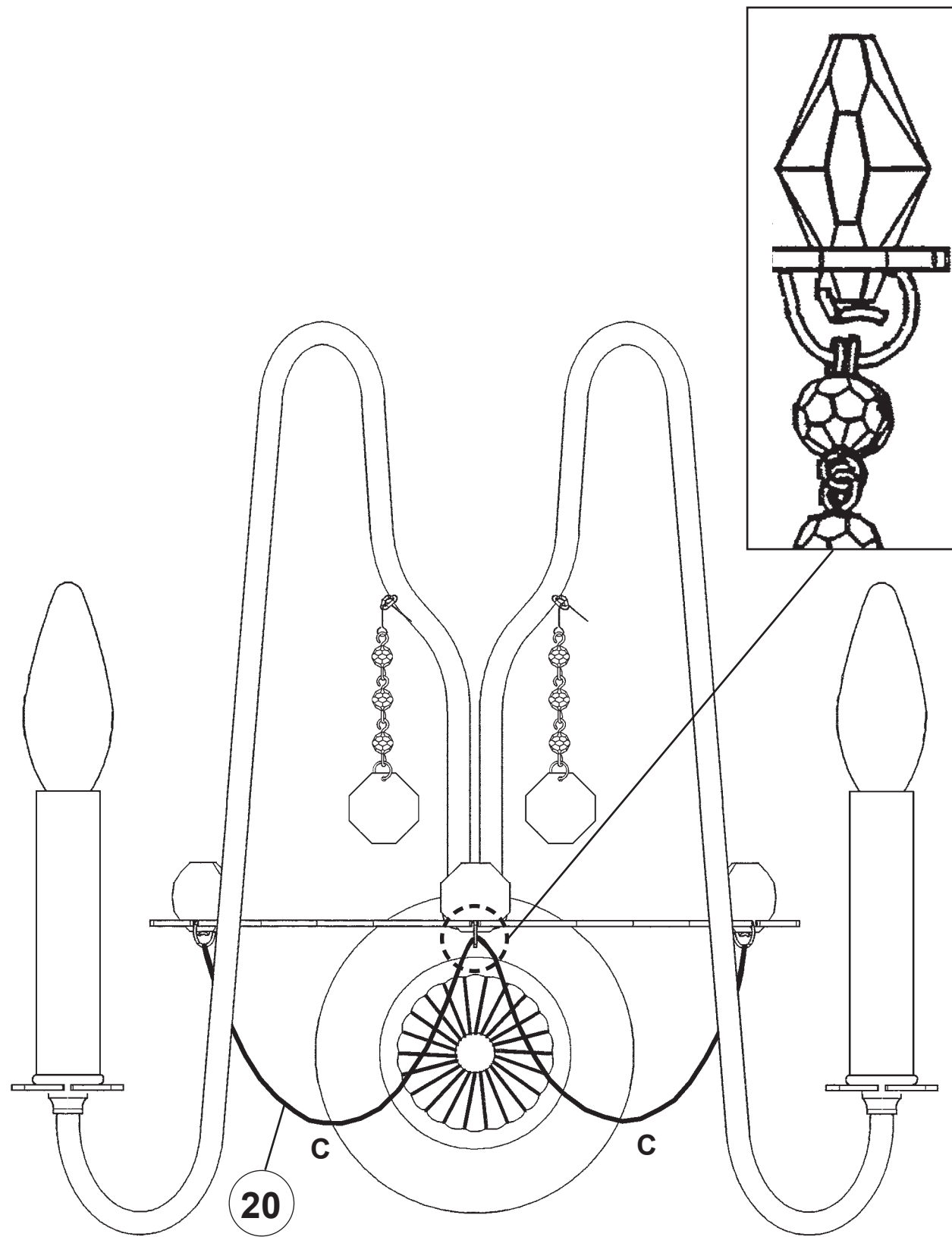

ESMERY AR1002N-__ __S

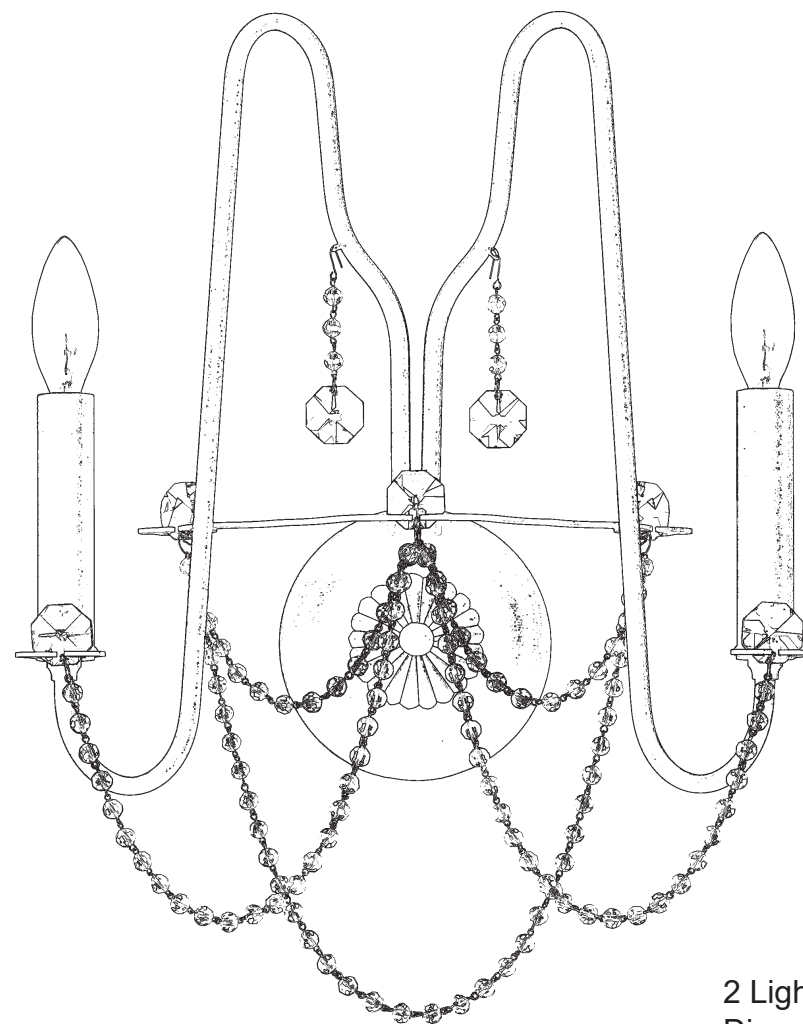











2 Lights
Diameter: 12-1/2"
Height: 16-1/2"
Extension: 7"
Hanging Weight: 2lbs.

THIS DESIGN IS THE PROPRIETARY
TRADE DRESS/TRADEMARK OF
W SCHONBEK LLC.

 **SCHONBEK** | 1870

 **SCHONBEK** | 1870

								
MAX 60 W	110-120 V							

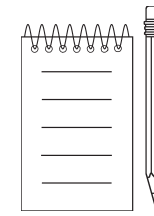
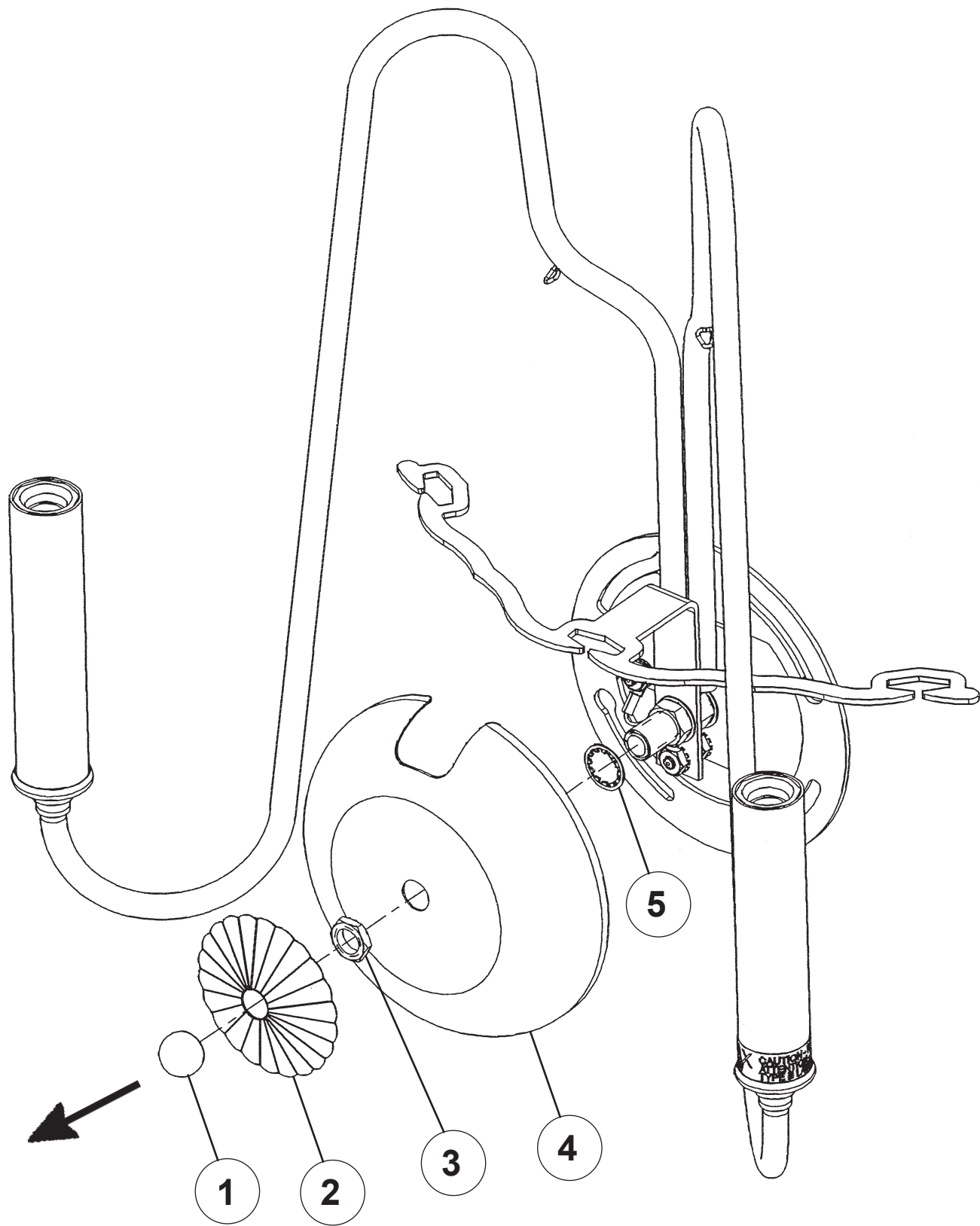

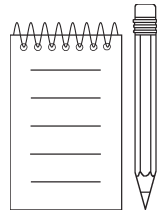

WARNING:

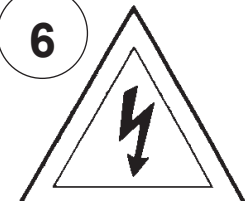
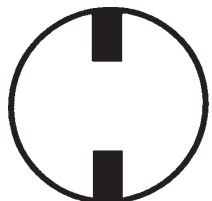
6  

Electrical Danger Turn Power Off

All electrical components must be installed by a licensed electrician in accordance with the National Electric Code and the appropriate local electrical codes.

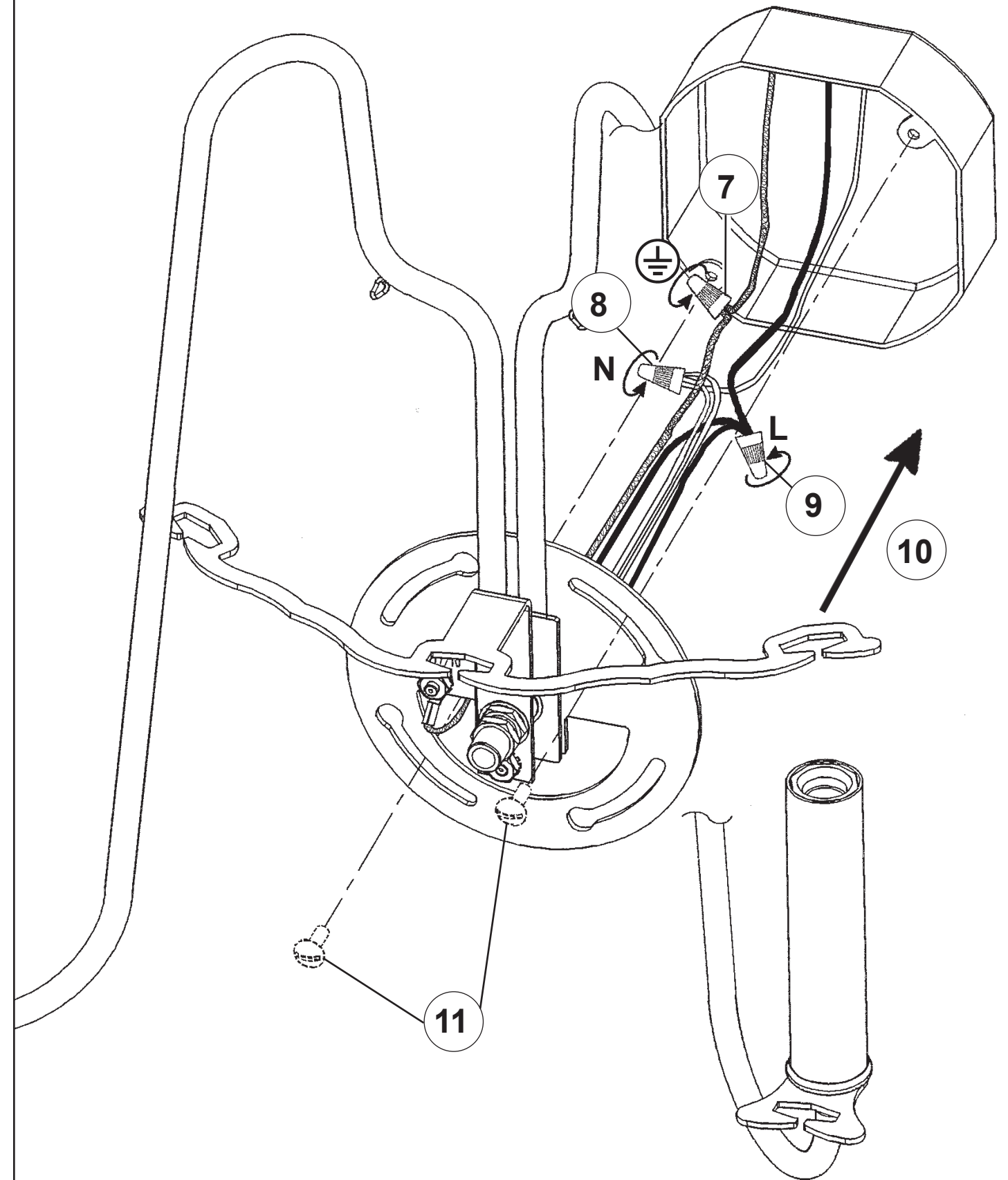

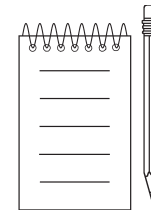
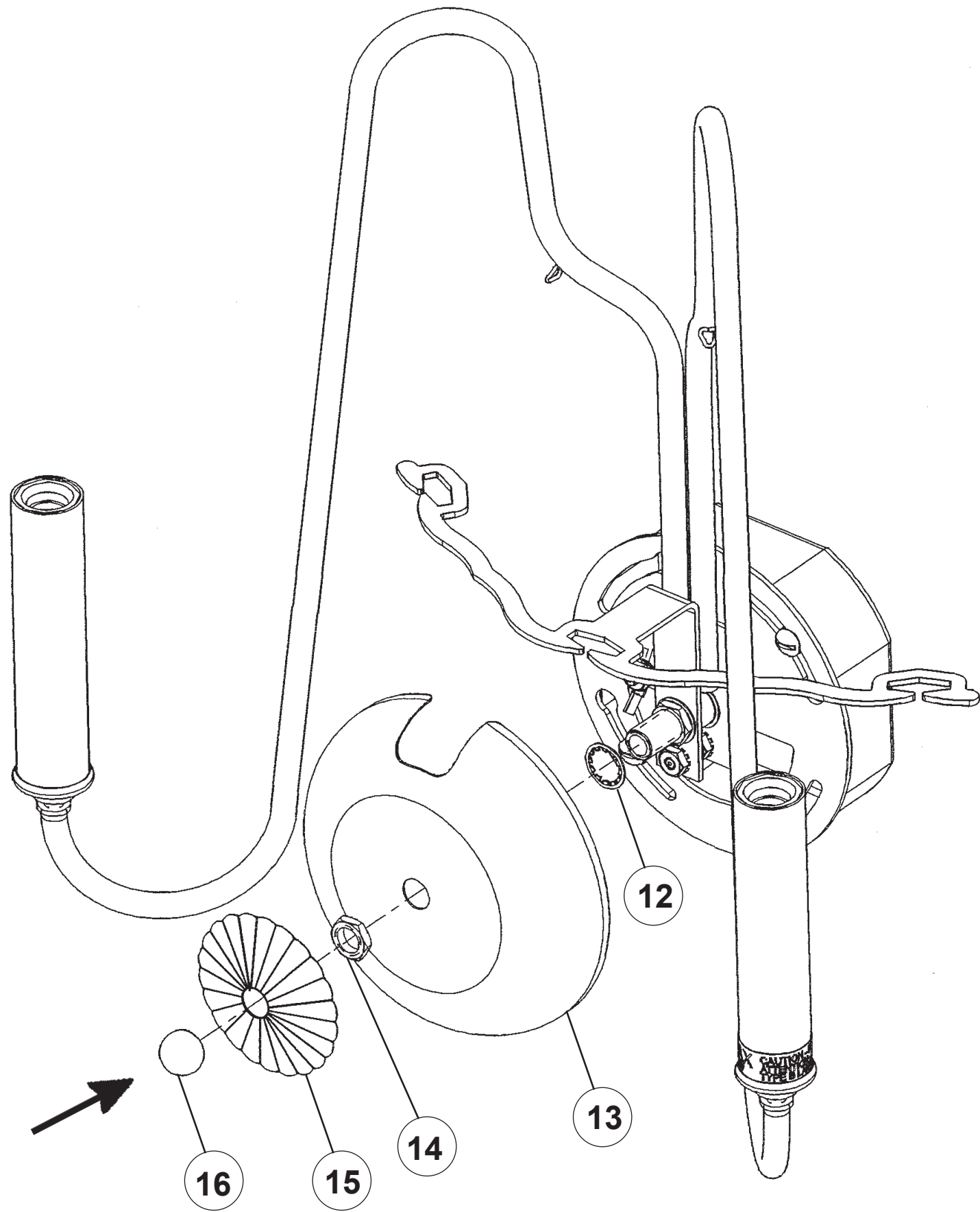

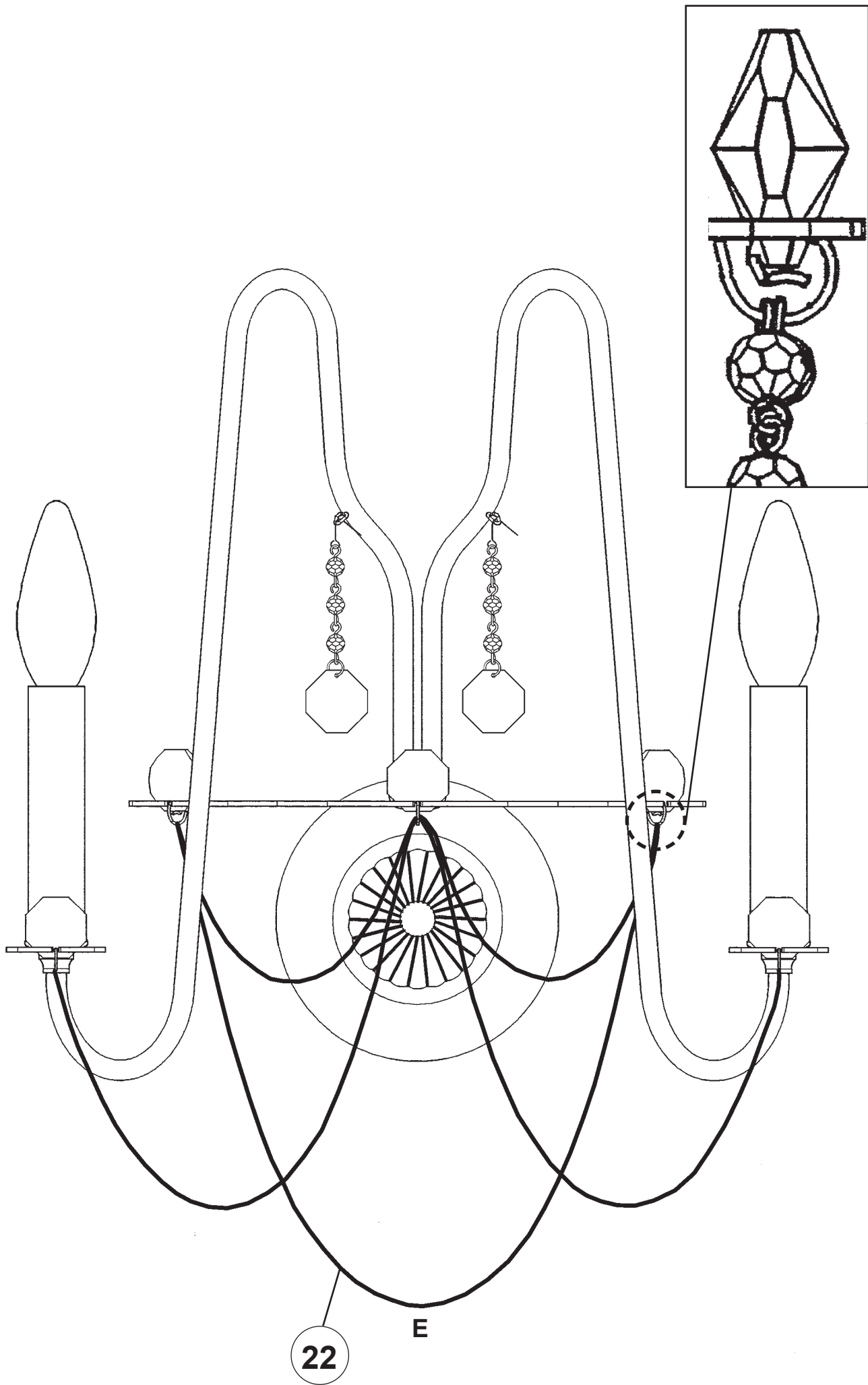

17



You will need 2 - B10
25 Watts Recommended
60 Watts Max

Install bulbs and be sure
to test fixture **BEFORE**
trimming.

