

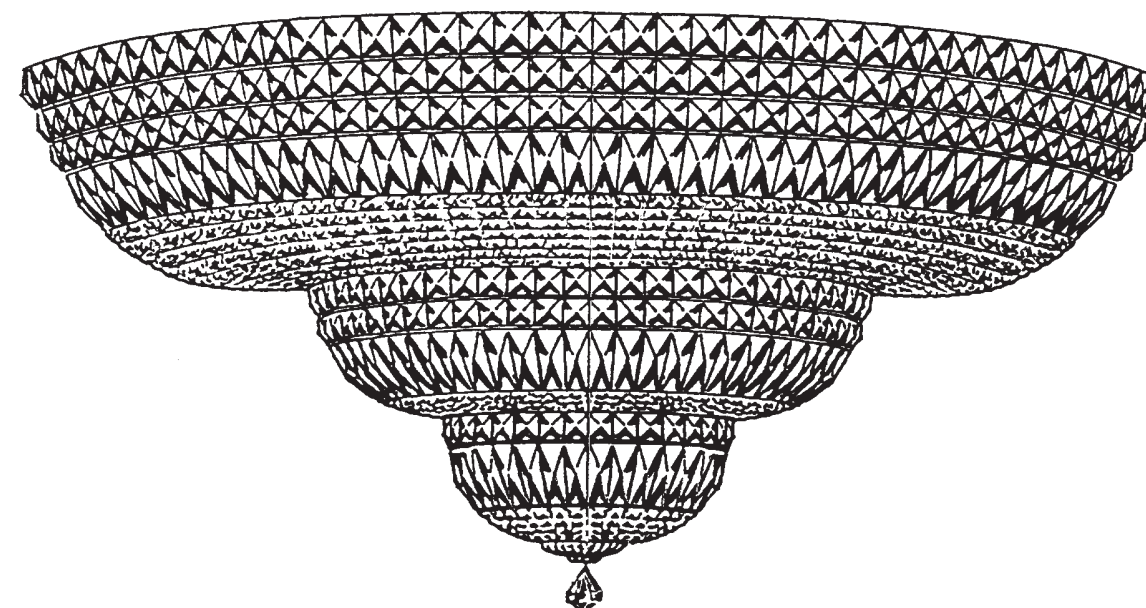

CHANDELIER 5897-____O TRIM DIAGRAM

(Finish Option)



THIS DESIGN IS THE PROPRIETARY TRADE DRESS/TRADEMARK OF W SCHONBEK LLC.

36 Lights
Diameter: 48"
Body Length: 21"



CAUTION... RISK OF ELECTRICAL SHOCK. Make sure the electrical supply to the chandelier is turned off at the main fuse or circuit breaker before doing any installation. All electrical components must be installed by a licensed electrician in accordance with the National Electric Code and the appropriate local electrical codes.

HANGING WEIGHT: 190 pounds.

BULBS: (36) Round shaped candelabra base G16-1/2 bulbs, recommend 25 watts for best appearance.

25 - Watts Maximum

MIN 75°C SUPPLY CONDUCTORS

WARNING: This chandelier meets UL/CSA requirements. Any tampering will void UL/CSA certification.

IMPORTANT

Please record the following information for future service.

CODE	# _____	Four-digit number on outside of carton.
PACKER	# _____	See crystal package label.
ORDER	# _____	See crystal package label.

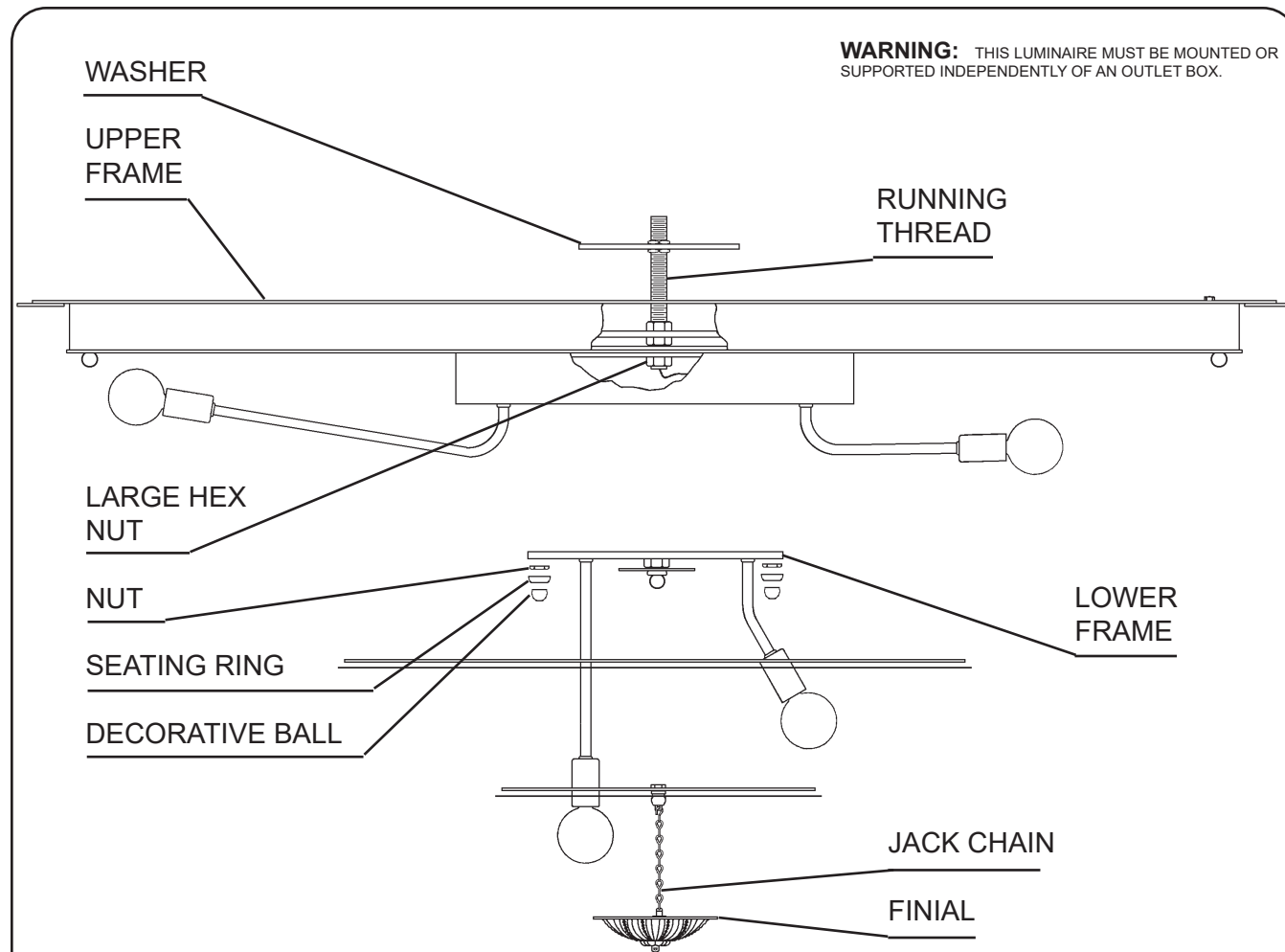

1 MAKE SURE POWER IS DISCONNECTED!!

2 Attach washer to supporting member in ceiling sufficient to support weight of fixture.

3 Install upper frame assembly up over running thread to fit tight against the washer and secure with large hex nut.

4 Again, make sure that power is disconnected. Connect power wires in ceiling. Fixture **MUST** be grounded.

5 Attach lower frame assembly to upper frame assembly with nuts. Cover nuts with seating ring and decorative balls.

6 Install bulbs, connect power and test fixture before trimming.

7 Attach finial assembly from half ball with metal jack chain. The finial assembly should hang freely from the metal jack chain.

NOTES:

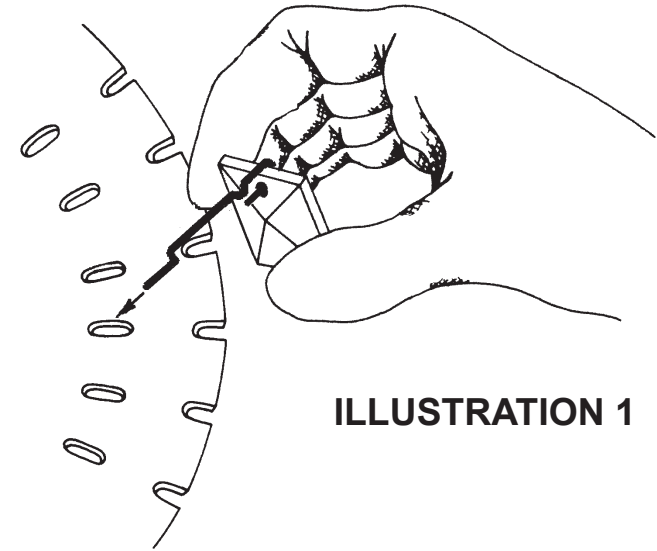

ILLUSTRATION 1

12 Reminder: Hang upper gallery Chains "A" FIRST! Hook all Crystal Chains "F" into slots in the mirror plate so the metal accessories face outwards and the square jewel is on the upper end. See illustrations #1 - #3. NOTE: Allow ends with small jewels to hang loose.

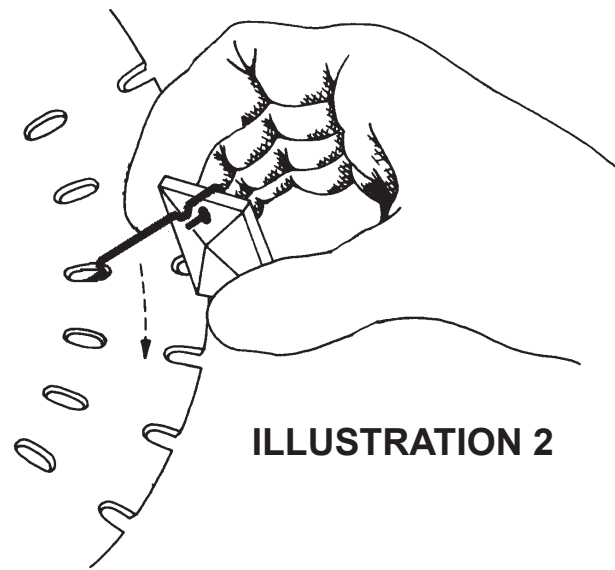

ILLUSTRATION 2

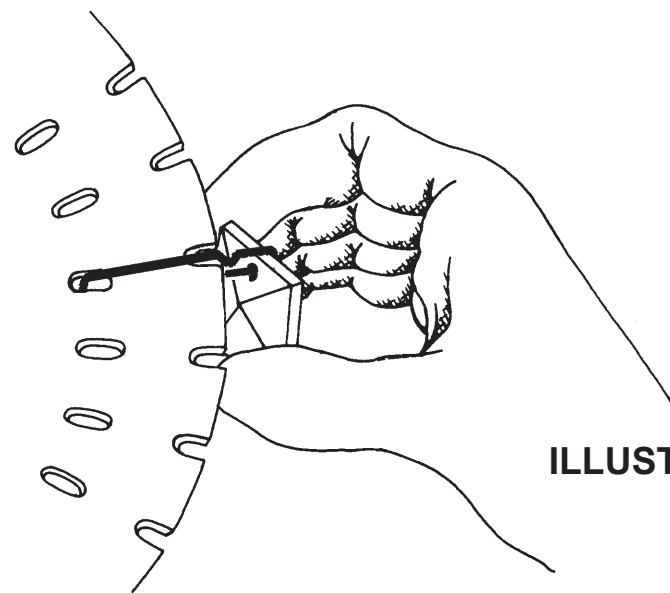
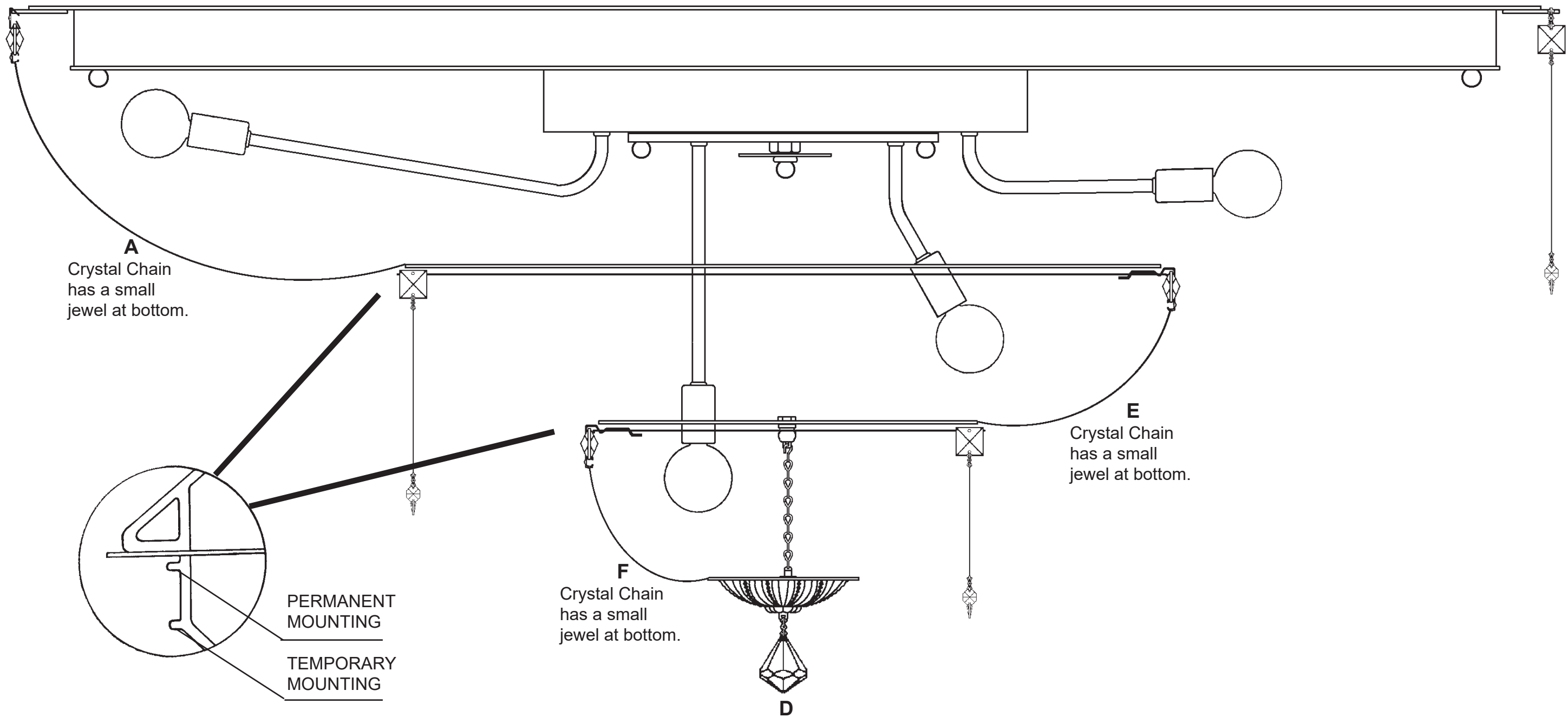

ILLUSTRATION 3

NOTES:



8 Hang upper mirror Chains "A" FIRST. Hook all Chains "A" into holes in the outer ring so that the metal accessories face outwards and square jewel is on the upper end. Hook the loose end of Crystal Chains "A" with small jewels into holes of solid mounted metal ring.

9 Hook all chains "E" in the middle mirror plate (resting on temporary mounting) so that the metal accessories face outwards and square jewel is on the upper end. (See page 6 for detailed instructions). Align notches in middle mirror plate with the permanent mounting, raise mirror plate over permanent mounting, then turn until notches are halfway between permanent mounting. (See detailed drawing). Hook loose ends of chains "E" into solid mounted metal ring.

10 Hook all chains "F" in the lower mirror plate (resting on temporary mounting) so that the metal accessories face outwards and square jewel is on the upper end. (See page 6 for detailed instructions). Align notches in lower mirror plate with the permanent mounting, raise mirror plate over permanent mounting, then turn until notches are halfway between permanent mounting. (See detailed drawing). Hook loose ends of chains "F" into finial.

11 Hook prism "D" into fitting below finial.



CHANDELIER 5897-____R TRIM DIAGRAM

(Finish Option)

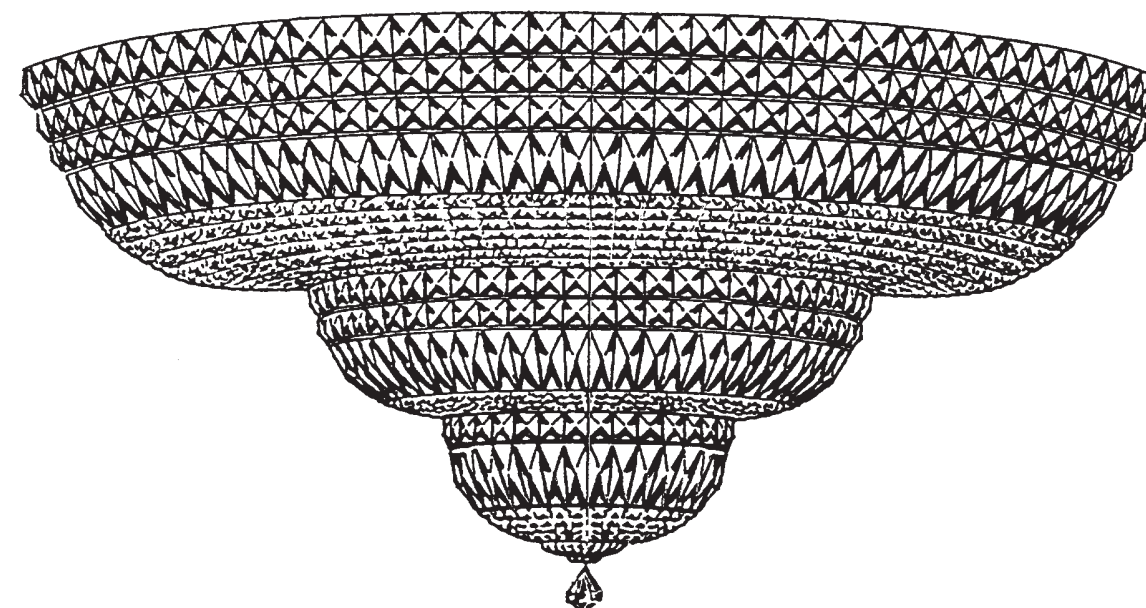

THIS DESIGN IS THE PROPRIETARY TRADE DRESS/TRADEMARK OF W SCHONBEK LLC.

36 Lights
Diameter: 48"
Body Length: 21"



CAUTION... RISK OF ELECTRICAL SHOCK. Make sure the electrical supply to the chandelier is turned off at the main fuse or circuit breaker before doing any installation. All electrical components must be installed by a licensed electrician in accordance with the National Electric Code and the appropriate local electrical codes.

HANGING WEIGHT: 190 pounds.

BULBS: (36) Round shaped candelabra base G16-1/2 bulbs, recommend 25 watts for best appearance.

25 - Watts Maximum

MIN 75°C SUPPLY CONDUCTORS

WARNING: This chandelier meets UL/CSA requirements. Any tampering will void UL/CSA certification.

IMPORTANT

Please record the following information for future service.

CODE	# _____	Four-digit number on outside of carton.
PACKER	# _____	See crystal package label.
ORDER	# _____	See crystal package label.

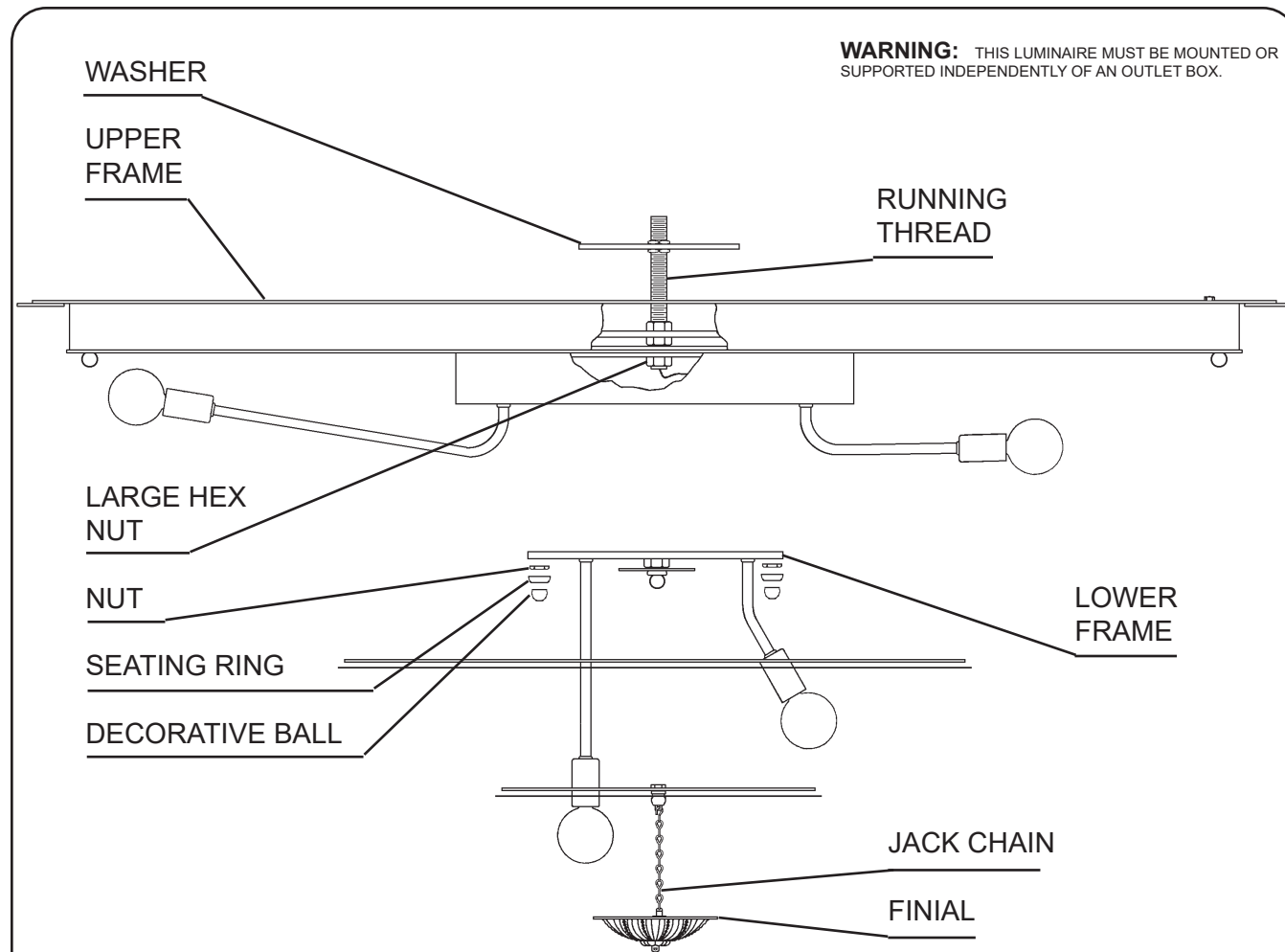

1 MAKE SURE POWER IS DISCONNECTED!!

2 Attach washer to supporting member in ceiling sufficient to support weight of fixture.

3 Install upper frame assembly up over running thread to fit tight against the washer and secure with large hex nut.

4 Again, make sure that power is disconnected. Connect power wires in ceiling. Fixture **MUST** be grounded.

5 Attach lower frame assembly to upper frame assembly with nuts. Cover nuts with seating ring and decorative balls.

6 Install bulbs, connect power and test fixture before trimming.

7 Attach finial assembly from half ball with metal jack chain. The finial assembly should hang freely from the metal jack chain.

NOTES:

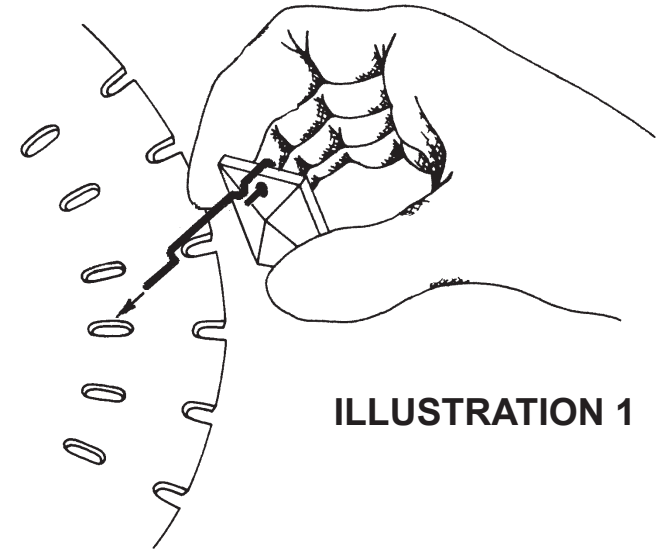

ILLUSTRATION 1

13 Reminder: Hang upper gallery Chains "A" FIRST! Hook all Crystal Chains "F" into slots in the mirror plate so the metal accessories face outwards and the square jewel is on the upper end. See illustrations #1 - #3. NOTE: Allow ends with small jewels to hang loose.

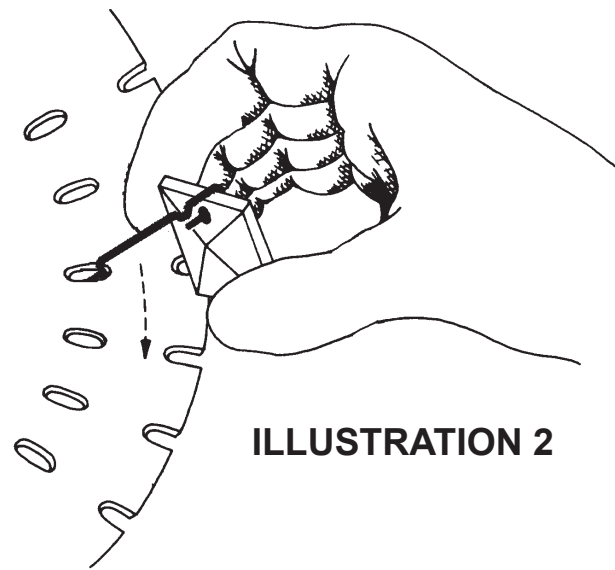

ILLUSTRATION 2

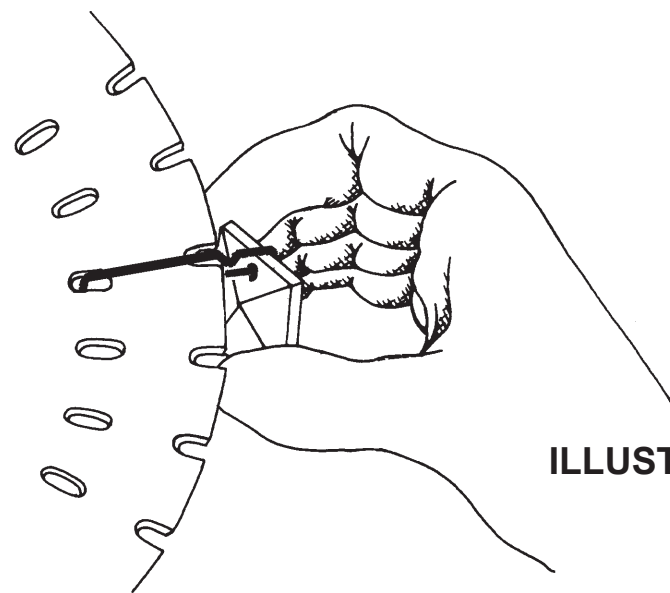
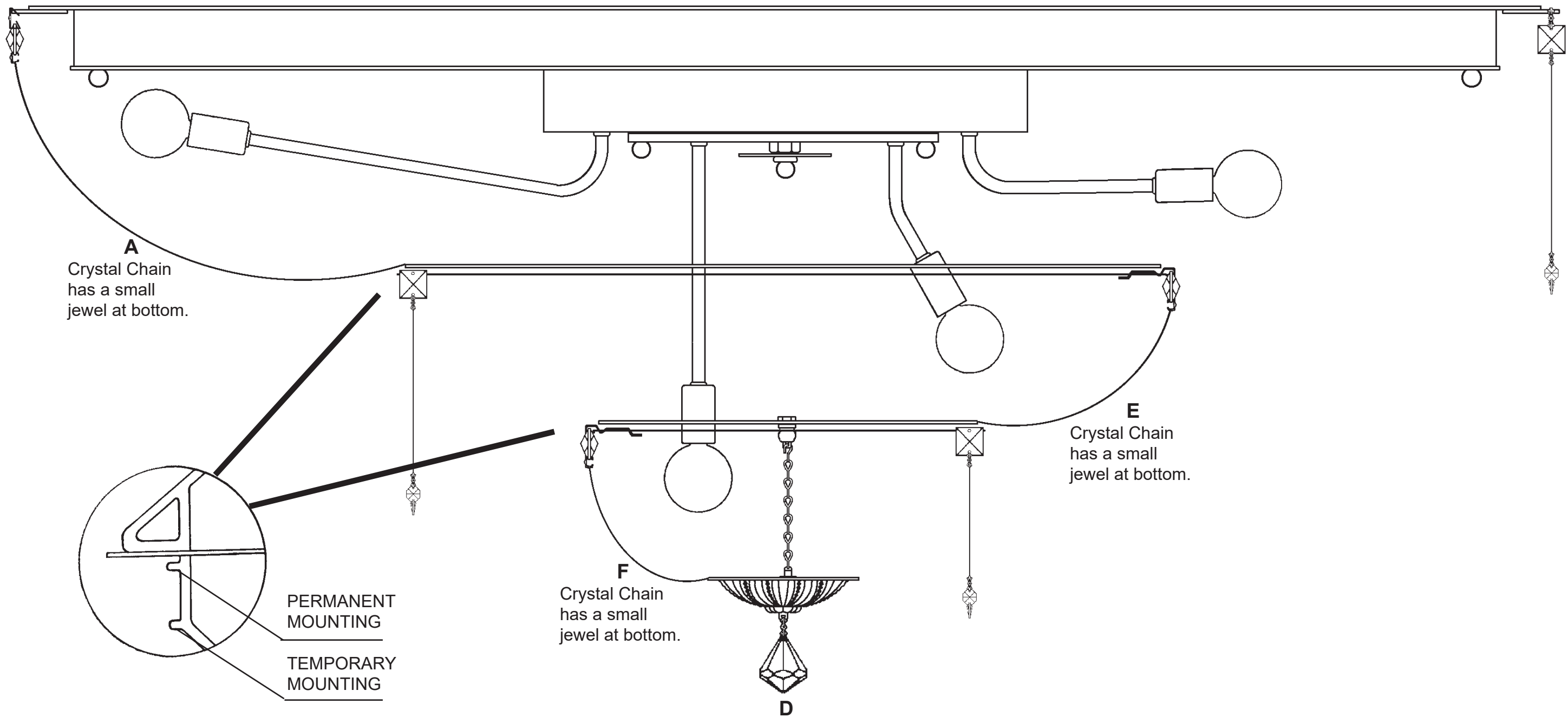

ILLUSTRATION 3

NOTES:



9 Hang upper mirror Chains "A" FIRST. Hook all Chains "A" into holes in the outer ring so that the metal accessories face outwards and square jewel is on the upper end. Hook the loose end of Crystal Chains "A" with small jewels into holes of solid mounted metal ring.

10 Hook all chains "E" in the middle mirror plate (resting on temporary mounting) so that the metal accessories face outwards and square jewel is on the upper end. (See page 6 for detailed instructions). Align notches in middle mirror plate with the permanent mounting, raise mirror plate over permanent mounting, then turn until notches are halfway between permanent mounting. (See detailed drawing). Hook loose ends of chains "E" into solid mounted metal ring.

11 Hook all chains "F" in the lower mirror plate (resting on temporary mounting) so that the metal accessories face outwards and square jewel is on the upper end. (See page 6 for detailed instructions). Align notches in lower mirror plate with the permanent mounting, raise mirror plate over permanent mounting, then turn until notches are halfway between permanent mounting. (See detailed drawing). Hook loose ends of chains "F" into finial.

12 Hook prism "D" into fitting below finial.



CHANDELIER 5897-____S TRIM DIAGRAM

(Finish Option)

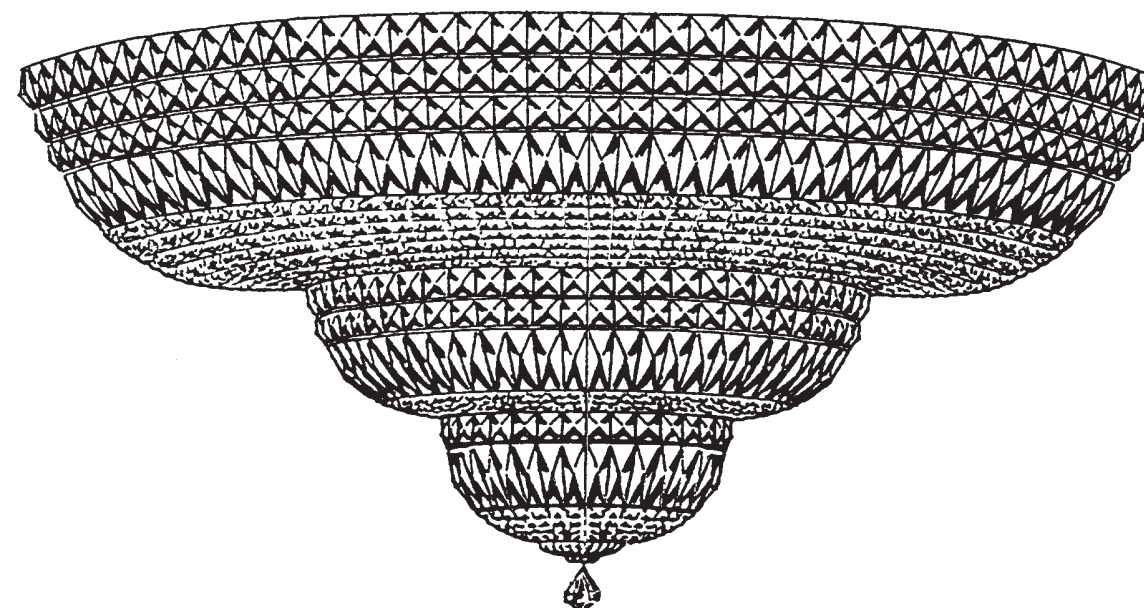

THIS DESIGN IS THE PROPRIETARY TRADE DRESS/TRADEMARK OF W SCHONBEK LLC.

36 Lights
Diameter: 48"
Body Length: 21"



CAUTION... RISK OF ELECTRICAL SHOCK. Make sure the electrical supply to the chandelier is turned off at the main fuse or circuit breaker before doing any installation. All electrical components must be installed by a licensed electrician in accordance with the National Electric Code and the appropriate local electrical codes.

HANGING WEIGHT: 190 pounds.

BULBS: (36) Round shaped candelabra base G16-1/2 bulbs, recommend 25 watts for best appearance.

25 - Watts Maximum

MIN 75°C SUPPLY CONDUCTORS

WARNING: This chandelier meets UL/CSA requirements. Any tampering will void UL/CSA certification.

IMPORTANT

Please record the following information for future service.

CODE # _____ Four-digit number on outside of carton.
PACKER # _____ See crystal package label.
ORDER # _____ See crystal package label.

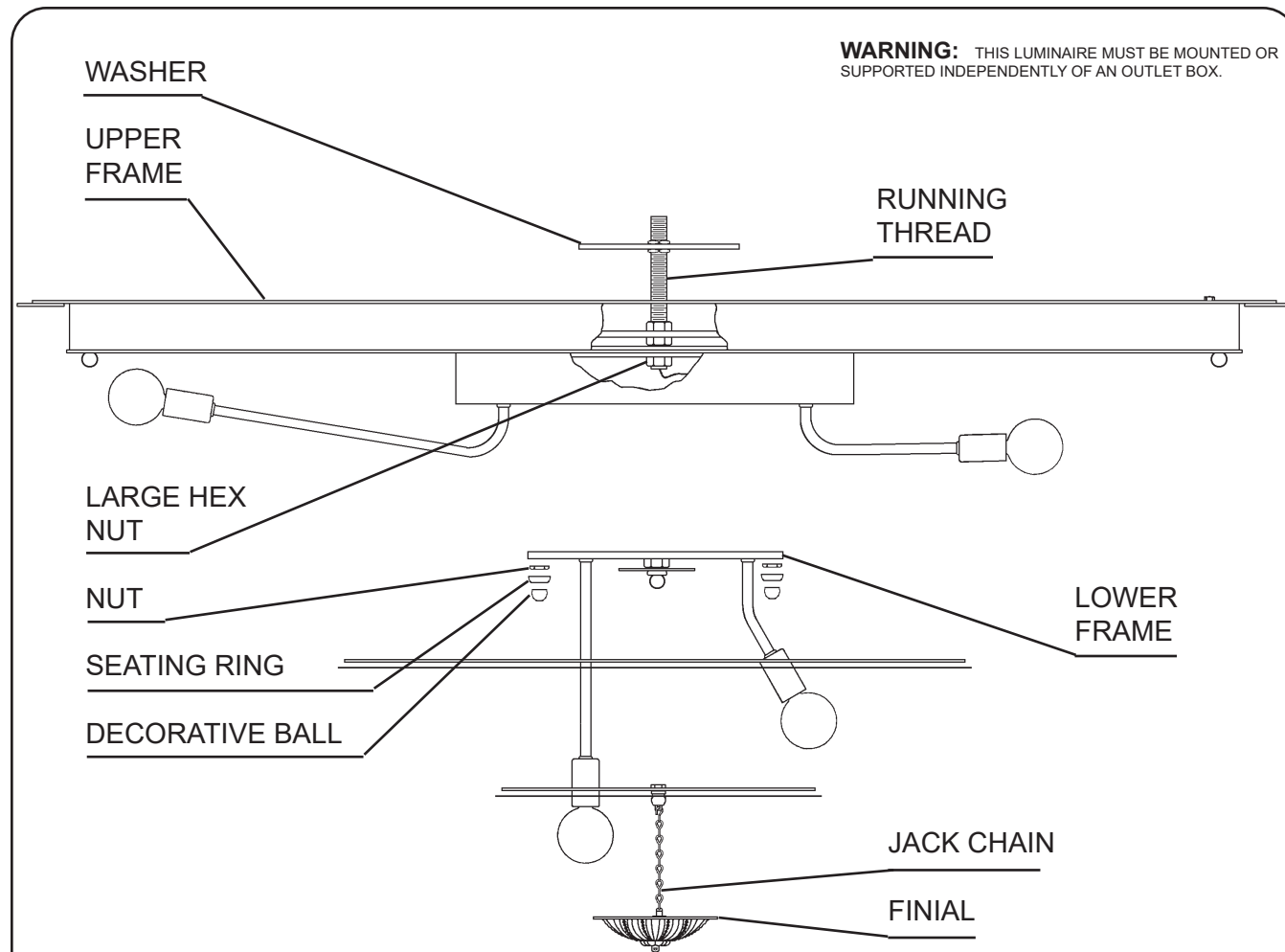

WARNING: THIS LUMINAIRE MUST BE MOUNTED OR SUPPORTED INDEPENDENTLY OF AN OUTLET BOX.

NOTES:

- 1** MAKE SURE POWER IS DISCONNECTED!!
- 2** Attach washer to supporting member in ceiling sufficient to support weight of fixture.
- 3** Install upper frame assembly up over running thread to fit tight against the washer and secure with large hex nut.
- 4** Again, make sure that power is disconnected. Connect power wires in ceiling. Fixture MUST be grounded.
- 5** Attach lower frame assembly to upper frame assembly with nuts. Cover nuts with seating ring and decorative balls.
- 6** Install bulbs, connect power and test fixture before trimming.
- 7** Attach finial assembly from half ball with metal jack chain. The finial assembly should hang freely from the metal jack chain.

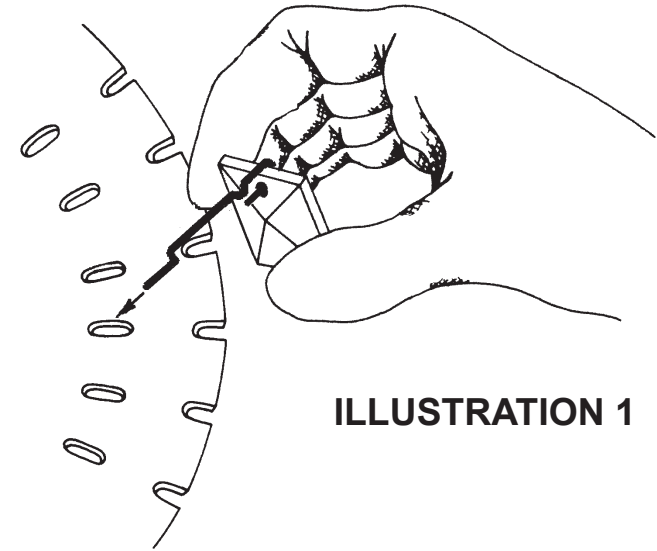

ILLUSTRATION 1

13 Reminder: Hang upper gallery Chains "A" FIRST! Hook all Crystal Chains "F" into slots in the mirror plate so the metal accessories face outwards and the square jewel is on the upper end. See illustrations #1 - #3. NOTE: Allow ends with small jewels to hang loose.

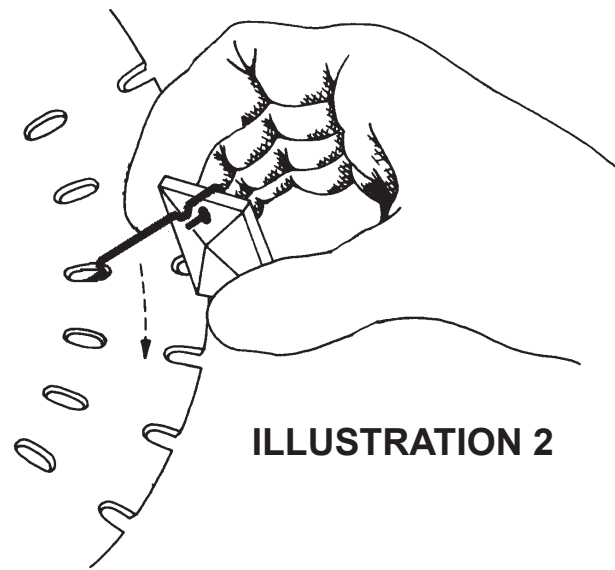

ILLUSTRATION 2

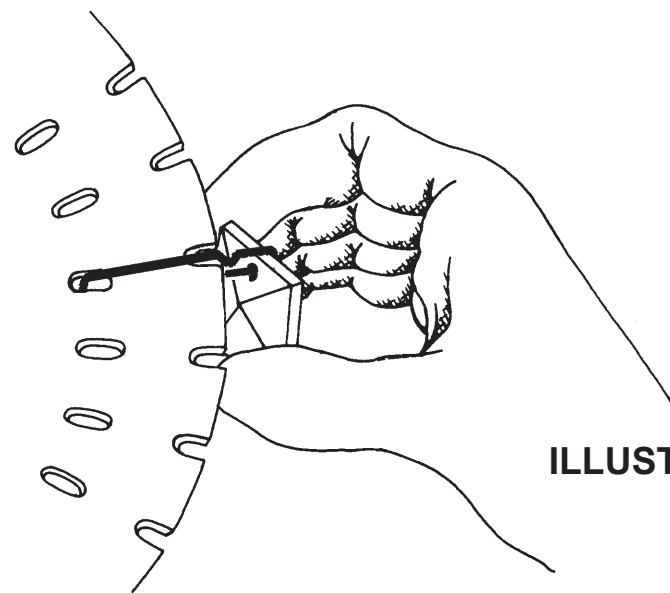
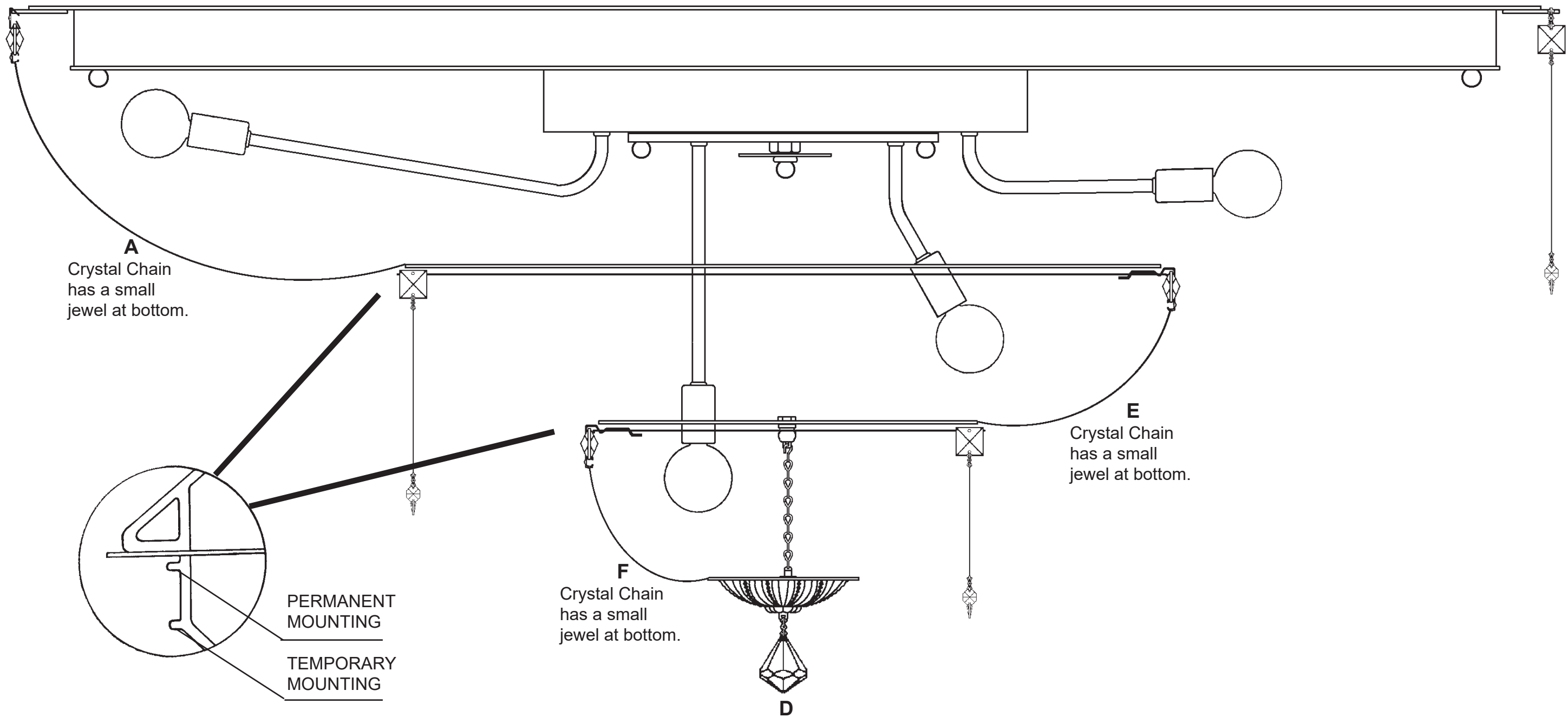

ILLUSTRATION 3

NOTES:



9 Hang upper mirror Chains "A" FIRST. Hook all Chains "A" into holes in the outer ring so that the metal accessories face outwards and square jewel is on the upper end. Hook the loose end of Crystal Chains "A" with small jewels into holes of solid mounted metal ring.

10 Hook all chains "E" in the middle mirror plate (resting on temporary mounting) so that the metal accessories face outwards and square jewel is on the upper end. (See page 6 for detailed instructions). Align notches in middle mirror plate with the permanent mounting, raise mirror plate over permanent mounting, then turn until notches are halfway between permanent mounting. (See detailed drawing). Hook loose ends of chains "E" into solid mounted metal ring.

11 Hook all chains "F" in the lower mirror plate (resting on temporary mounting) so that the metal accessories face outwards and square jewel is on the upper end. (See page 6 for detailed instructions). Align notches in lower mirror plate with the permanent mounting, raise mirror plate over permanent mounting, then turn until notches are halfway between permanent mounting. (See detailed drawing). Hook loose ends of chains "F" into finial.

12 Hook prism "D" into fitting below finial.