

PETIT CRYSTAL DELUXE 5895-__ __O

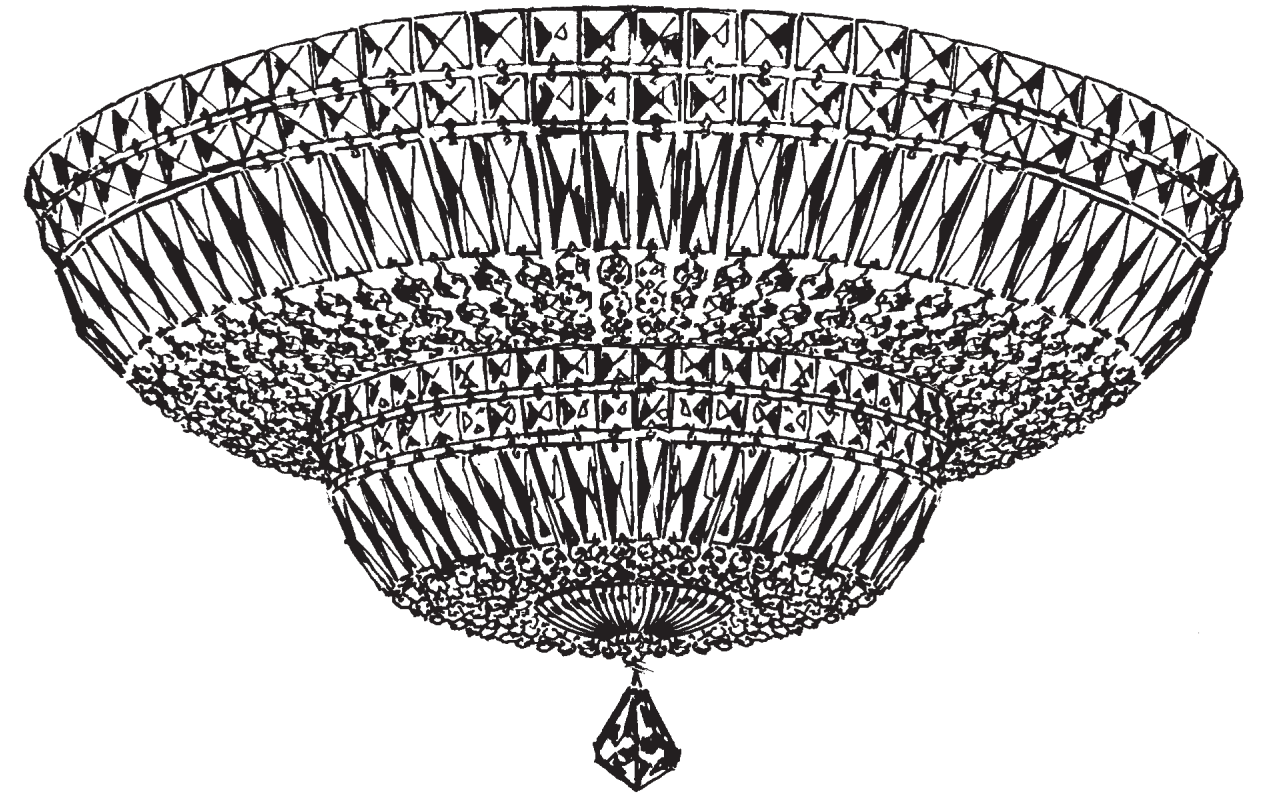











13 Lights
Diameter: 24"
Body Length: 12"
Hanging Weight: 24 lbs.

THIS DESIGN IS THE PROPRIETARY
TRADE DRESS/TRADEMARK OF
W SCHONBEK LLC.

 **SCHONBEK** | 1870

 **SCHONBEK** | 1870

| | | | | | | | | |
|---|---|---|---|---|---|---|---|---|
|  |  |  |  |  |  |  |  |  |
| MAX 25 W | | 110-120 V | |  | | | | |

All electrical components must be installed by a licensed electrician in accordance with the National Electric Code and the appropriate local electrical codes.

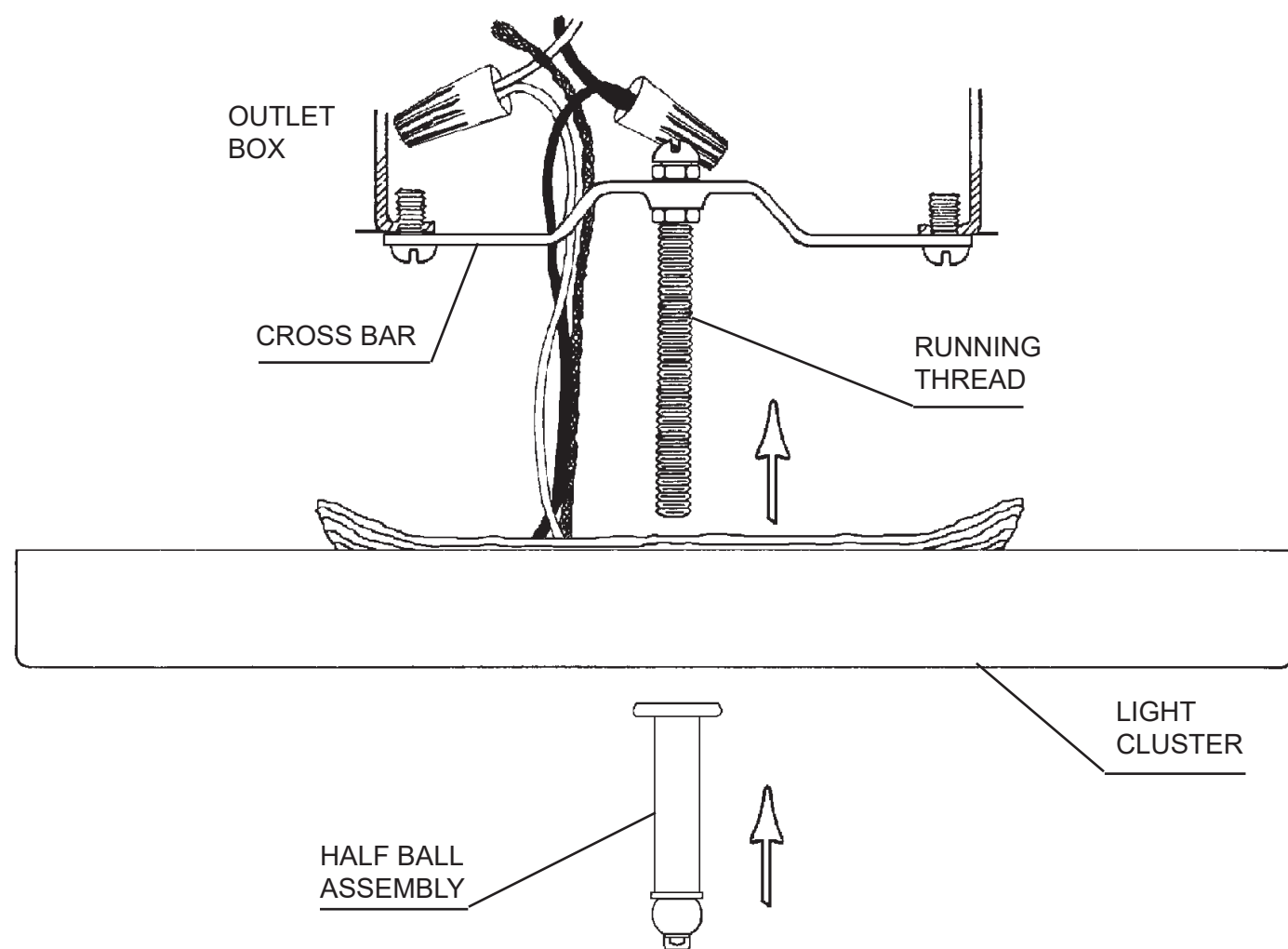

- 1** Remove crossbar from light cluster and attach to outlet box.
- 2** Feed stem wires through crossbar and attach to power wires in outlet box.
- 3** Place light cluster over thread attached to crossbar and secure with half ball assembly.

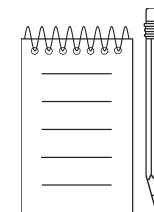



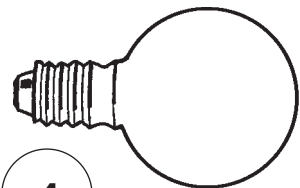

4

You will need 13 - G16-1/2
25 Watts Recommended
25 Watts Max
MIN 75°C SUPPLY
CONDUCTORS

Install bulbs and be sure to
test fixture BEFORE
trimming.



CRYSTAL CHAIN ASSEMBLY

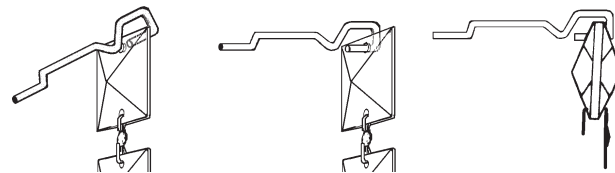

NOTE: There will be a slight resistance
when putting the pin through the top
crystal. Do NOT bend pin or try to scrape
out crystal hole. The resistance holds the
crystal chain on the pin.

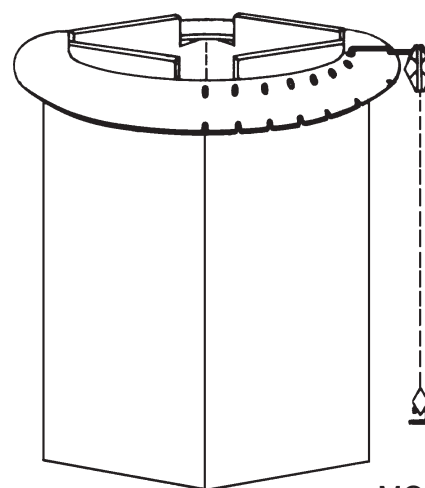

MOUNTING
POINTS

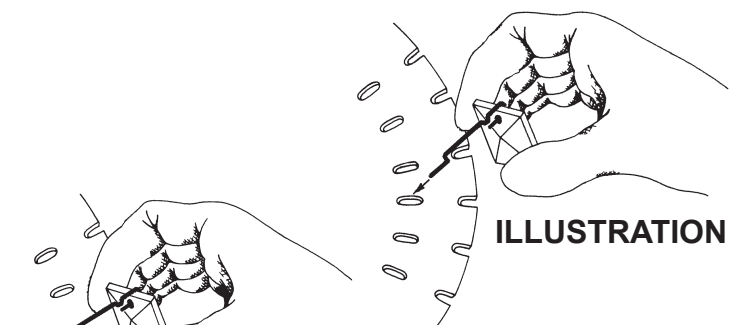

ILLUSTRATION 1



ILLUSTRATION 2

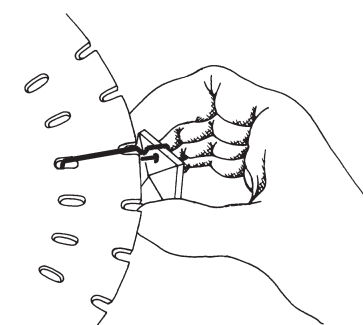
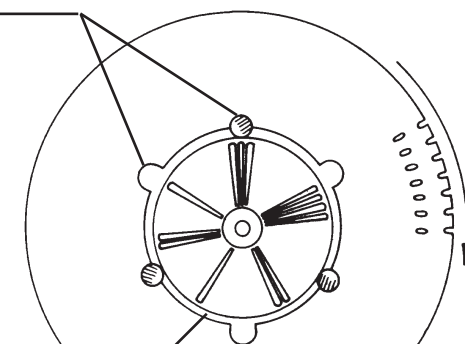

ILLUSTRATION 3



LIGHT
CLUSTER

MIRROR
PLATE

ILLUSTRATION 4

5 Assemble all crystal chains and pins provided. See "Crystal Chain Assembly" above. Hang upper gallery Chains "F" FIRST! Set mirror plate on cardboard stand. Hook all Crystal Chains "F" into slots in the mirror plate so the metal accessories face outwards and the square jewel is on the upper end. See illustrations #1 - #3. NOTE: Allow ends with small jewels to hang loose.

6 Align holes in mirror plate with the balls on the frame, raise mirror plate over balls, then turn mirror clockwise until holes are halfway between balls. See illustration #4.

9 Hang lower gallery Chains "G" SECOND! Turn cardboard stand over that was used for Chains "F" (notches on bottom and squeeze into a long diamond shape) and then set lower mirror plate on cardboard stand. Hook all Chains "G" into slots in the lower mirror plate so that the metal accessories face outwards and square jewel is on the upper end. (See illustrations #1 - #3.) NOTE: Allow ends with small jewels to hang loose.

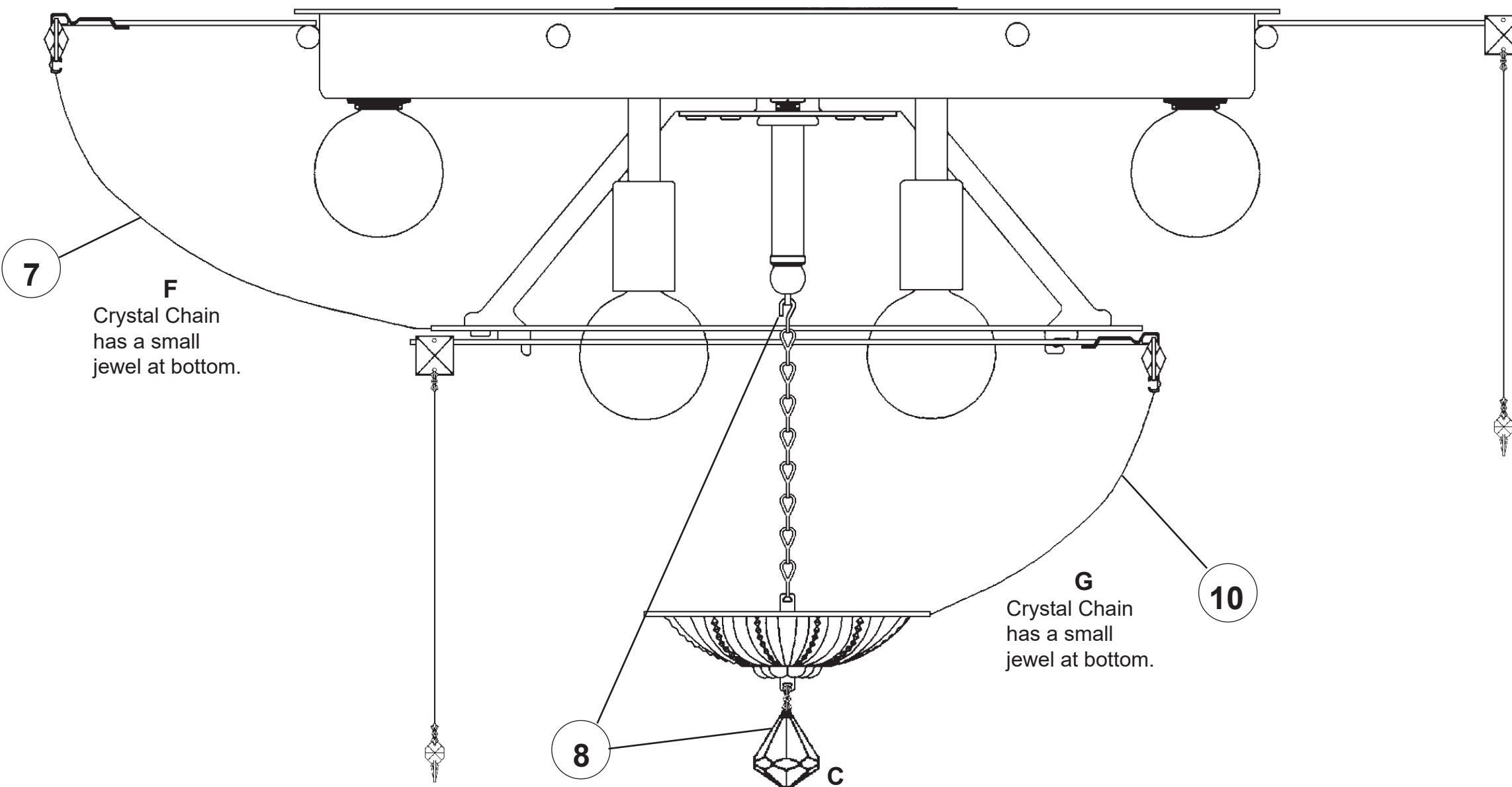

7

F
Crystal Chain
has a small
jewel at bottom.

8

G
Crystal Chain
has a small
jewel at bottom.

10

C

PETIT CRYSTAL DELUXE 5895-__ __R

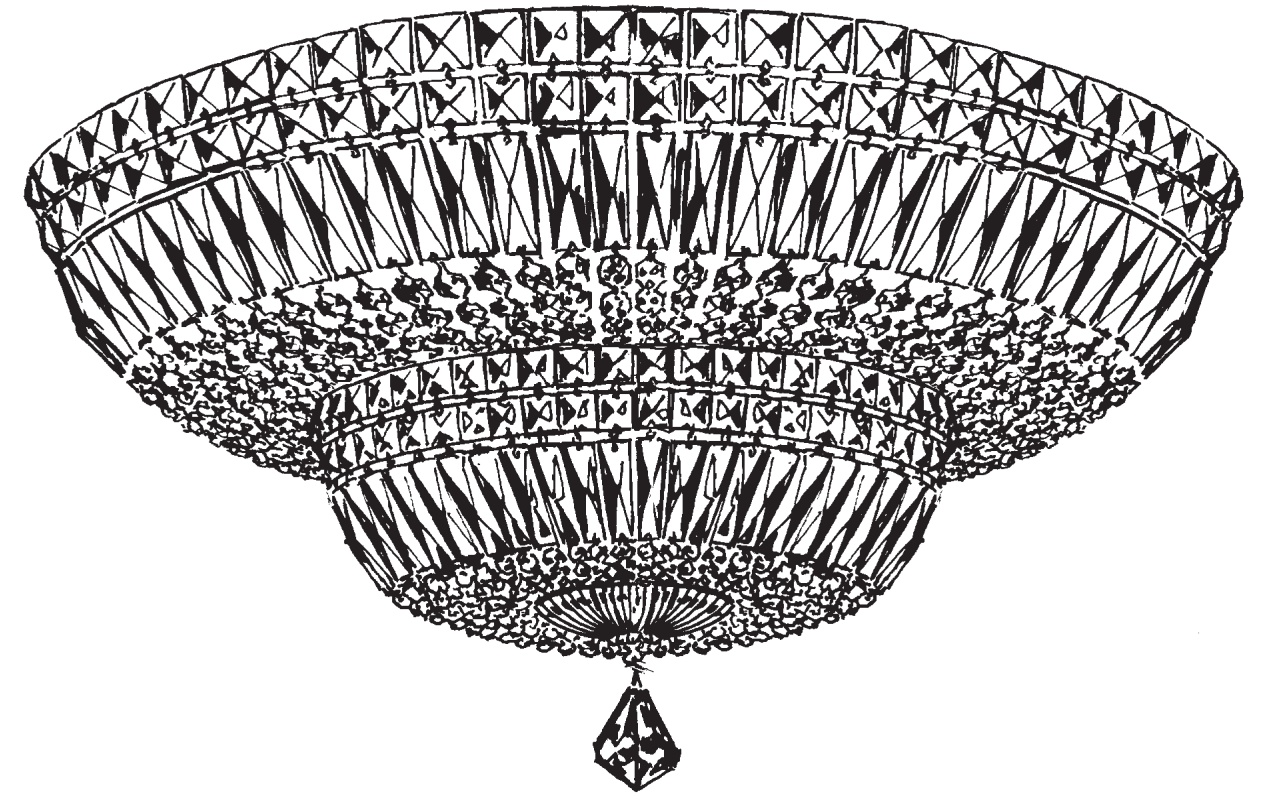











13 Lights
Diameter: 24"
Body Length: 12"
Hanging Weight: 24 lbs.

THIS DESIGN IS THE PROPRIETARY
TRADE DRESS/TRADEMARK OF
W SCHONBEK LLC.

 **SCHONBEK** | 1870

 **SCHONBEK** | 1870

| | | | | | | | | |
|---|---|---|---|---|---|---|---|---|
|  |  |  |  |  |  |  |  |  |
| MAX 25 W | | 110-120 V | |  | | | | |

All electrical components must be installed by a licensed electrician in accordance with the National Electric Code and the appropriate local electrical codes.

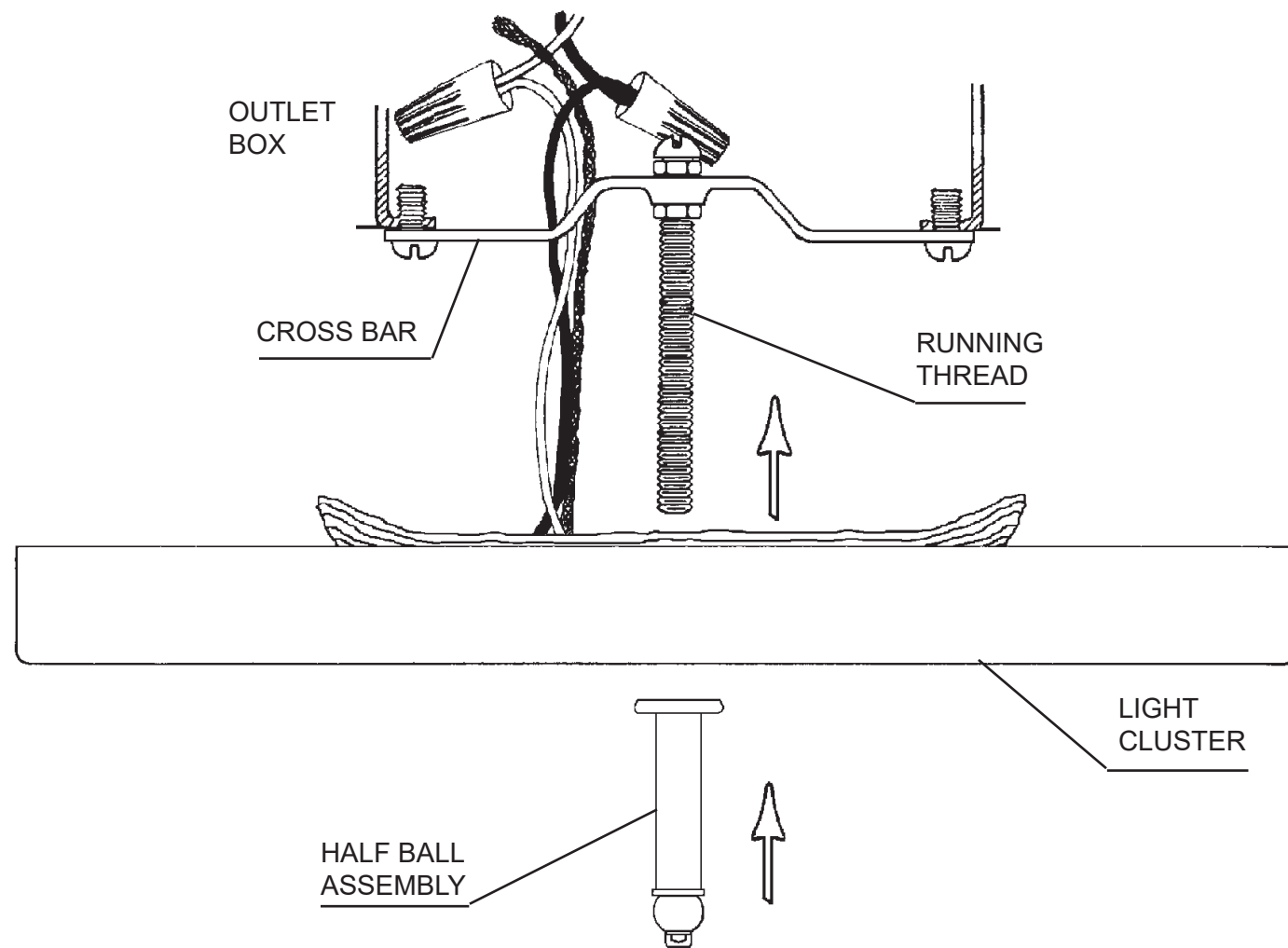

- 1** Remove crossbar from light cluster and attach to outlet box.
- 2** Feed stem wires through crossbar and attach to power wires in outlet box.
- 3** Place light cluster over thread attached to crossbar and secure with half ball assembly.

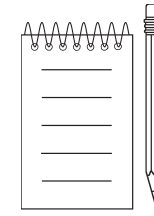

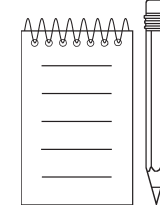
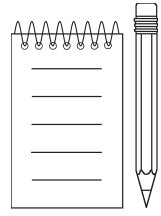

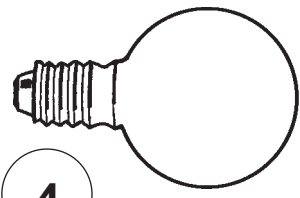

4

You will need 13 - G16-1/2
25 Watts Recommended
25 Watts Max
MIN 75°C SUPPLY
CONDUCTORS

Install bulbs and be sure to
test fixture **BEFORE**
trimming.

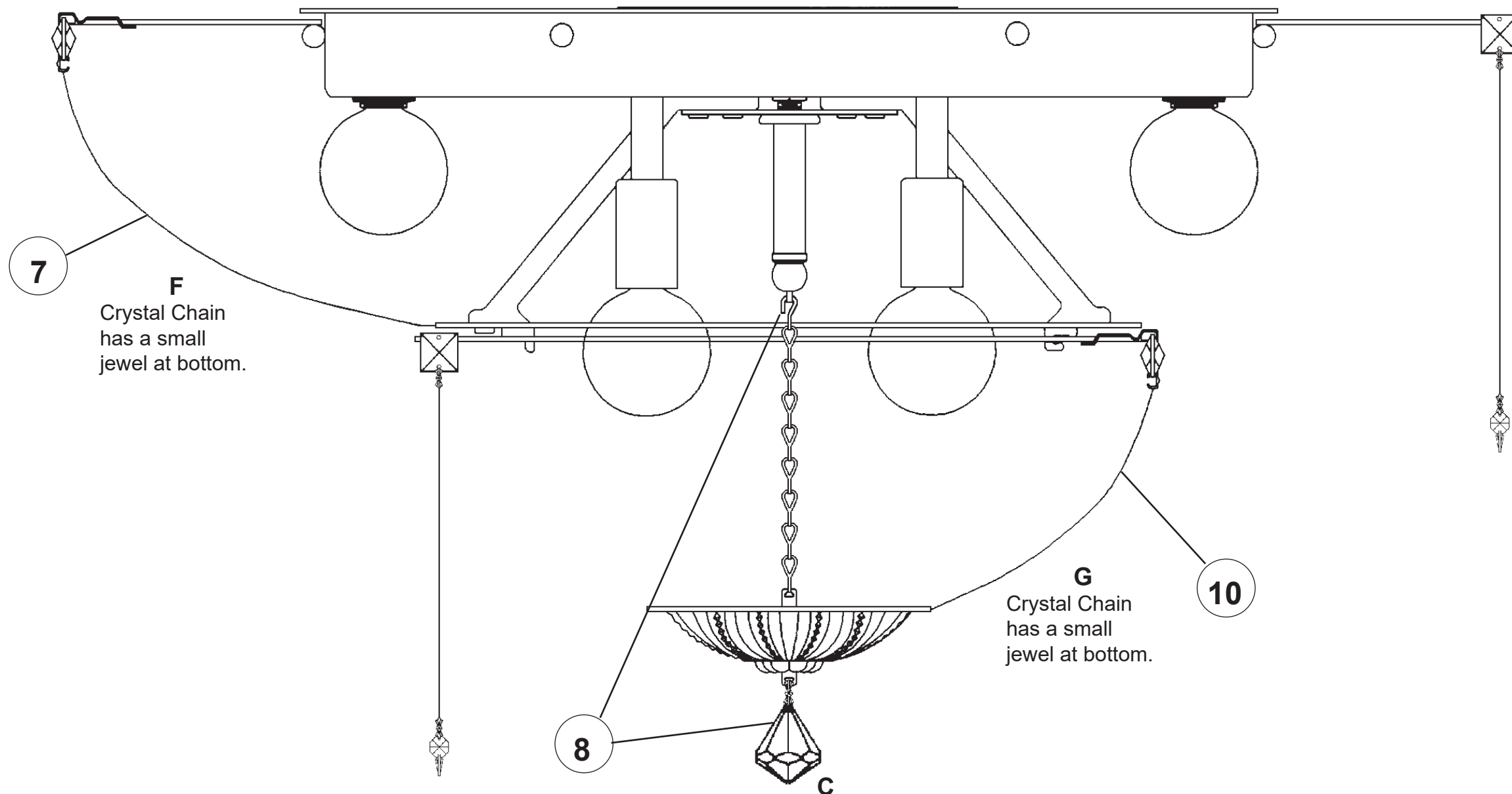

7

F
Crystal Chain
has a small
jewel at bottom.

G

Crystal Chain
has a small
jewel at bottom.

10

8

C

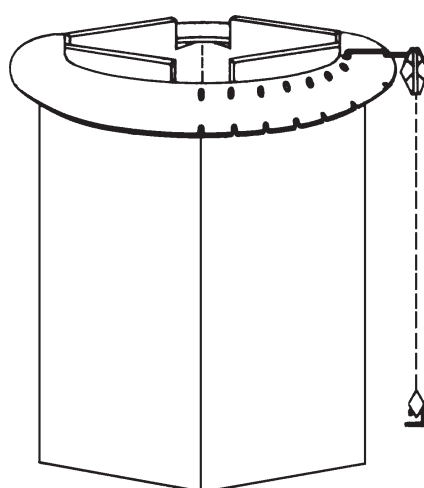

5 Hang upper gallery Chains "F" **FIRST!** Set mirror plate on cardboard stand. Hook all Crystal Chains "F" into slots in the mirror plate so the metal accessories face outwards and the square jewel is on the upper end. See illustrations #1 - #3. NOTE: Allow ends with small jewels to hang loose.

9 Hang lower gallery Chains "G" **SECOND!** Turn cardboard stand over that was used for Chains "F" (notches on bottom and squeeze into a long diamond shape) and then set lower mirror plate on cardboard stand. Hook all Chains "G" into slots in the lower mirror plate so that the metal accessories face outwards and square jewel is on the upper end. (See illustrations #1 - #3.) NOTE: Allow ends with small jewels to hang loose.

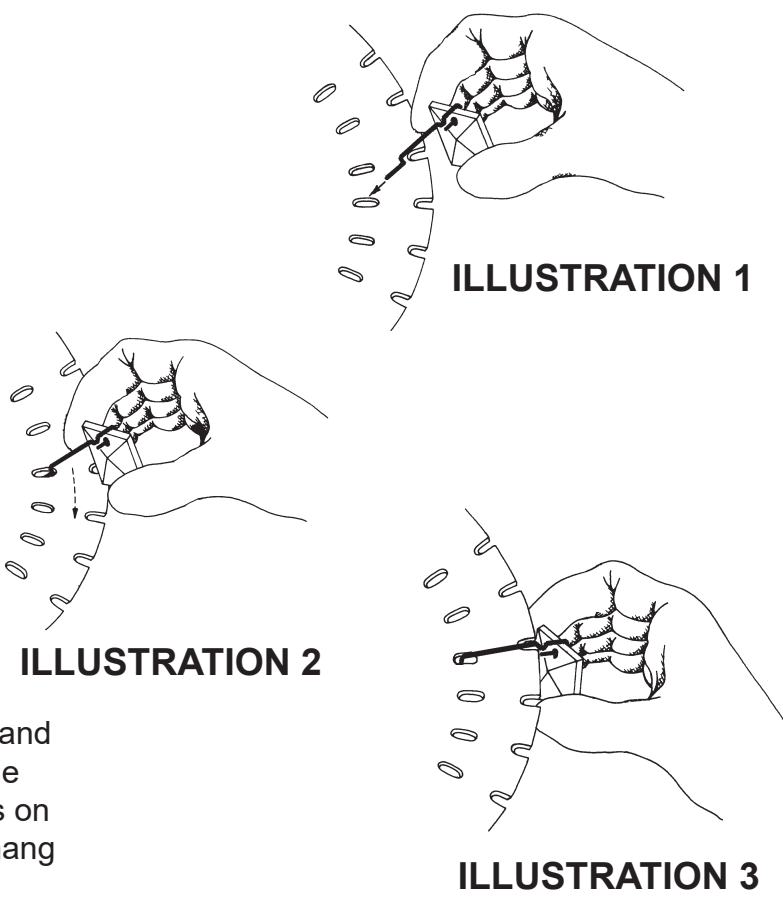

ILLUSTRATION 1

ILLUSTRATION 2

ILLUSTRATION 3

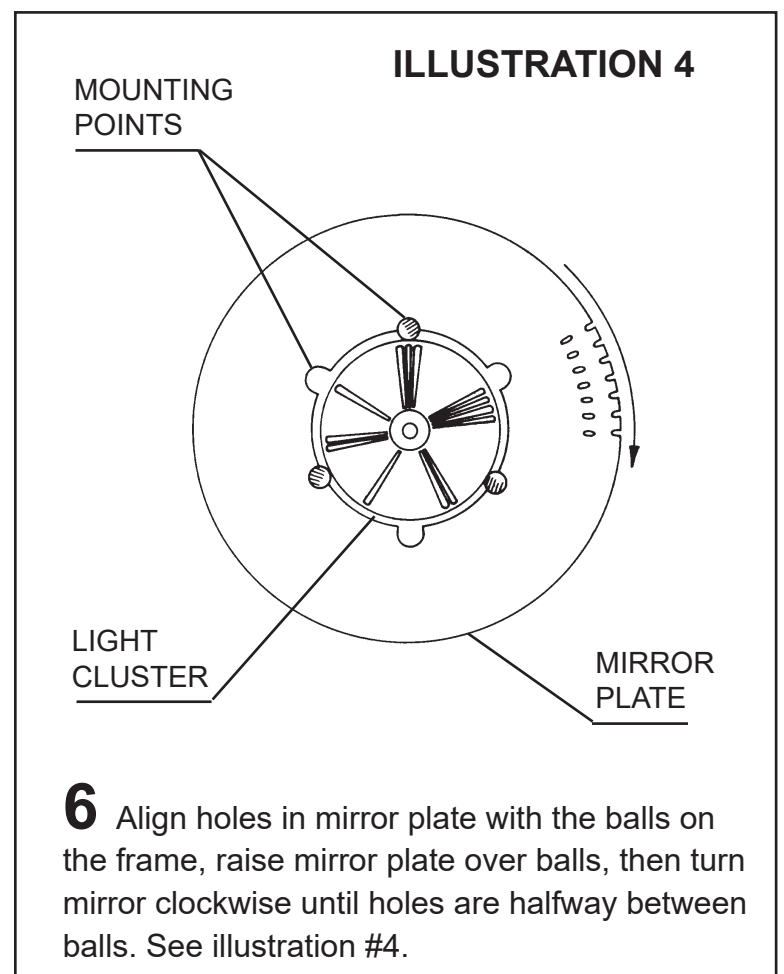
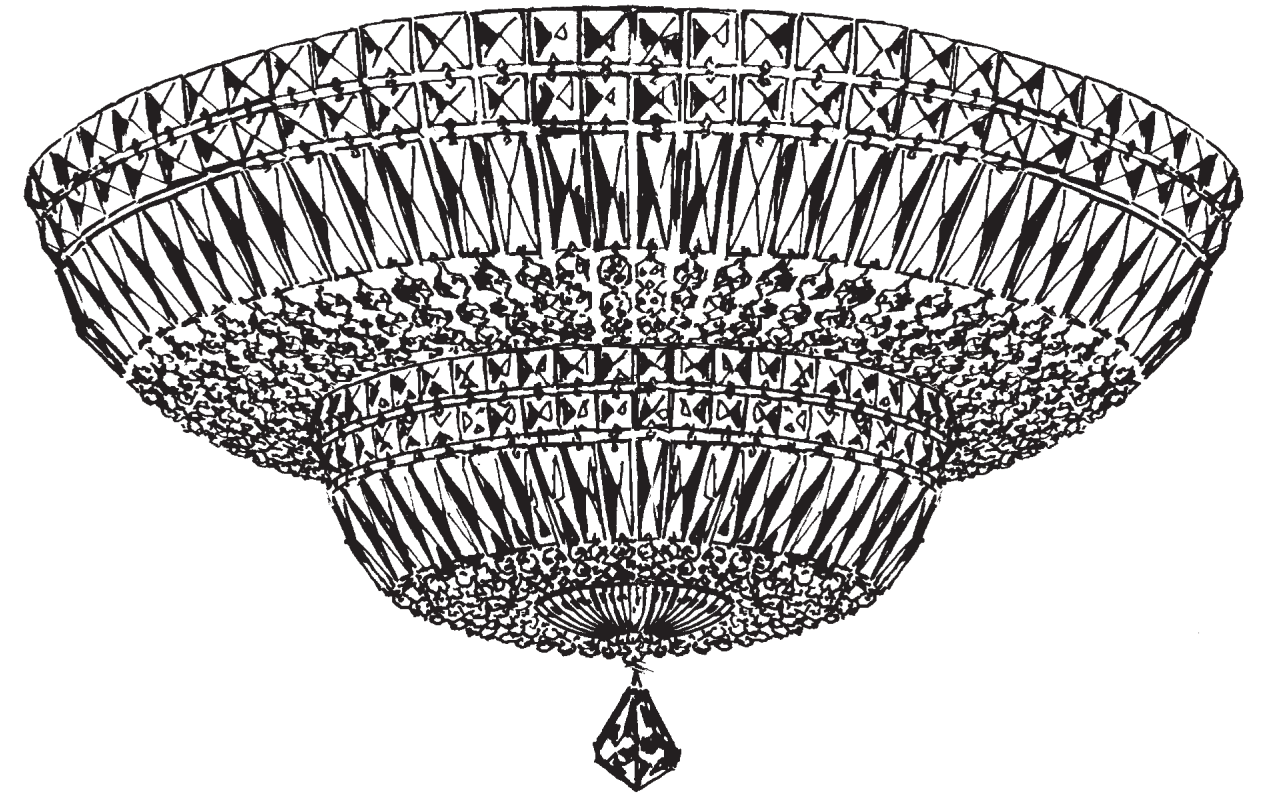

ILLUSTRATION 4

6 Align holes in mirror plate with the balls on the frame, raise mirror plate over balls, then turn mirror clockwise until holes are halfway between balls. See illustration #4.

PETIT CRYSTAL DELUXE 5895-__ __S













13 Lights
Diameter: 24"
Body Length: 12"
Hanging Weight: 24 lbs.

THIS DESIGN IS THE PROPRIETARY
TRADE DRESS/TRADEMARK OF
W SCHONBEK LLC.

 **SCHONBEK** | 1870

 **SCHONBEK** | 1870

| | | | | | | | | |
|---|---|---|---|---|---|---|---|---|
|  |  |  |  |  |  |  |  |  |
| MAX 25 W | | 110-120 V | |  | | | | |

All electrical components must be installed by a licensed electrician in accordance with the National Electric Code and the appropriate local electrical codes.

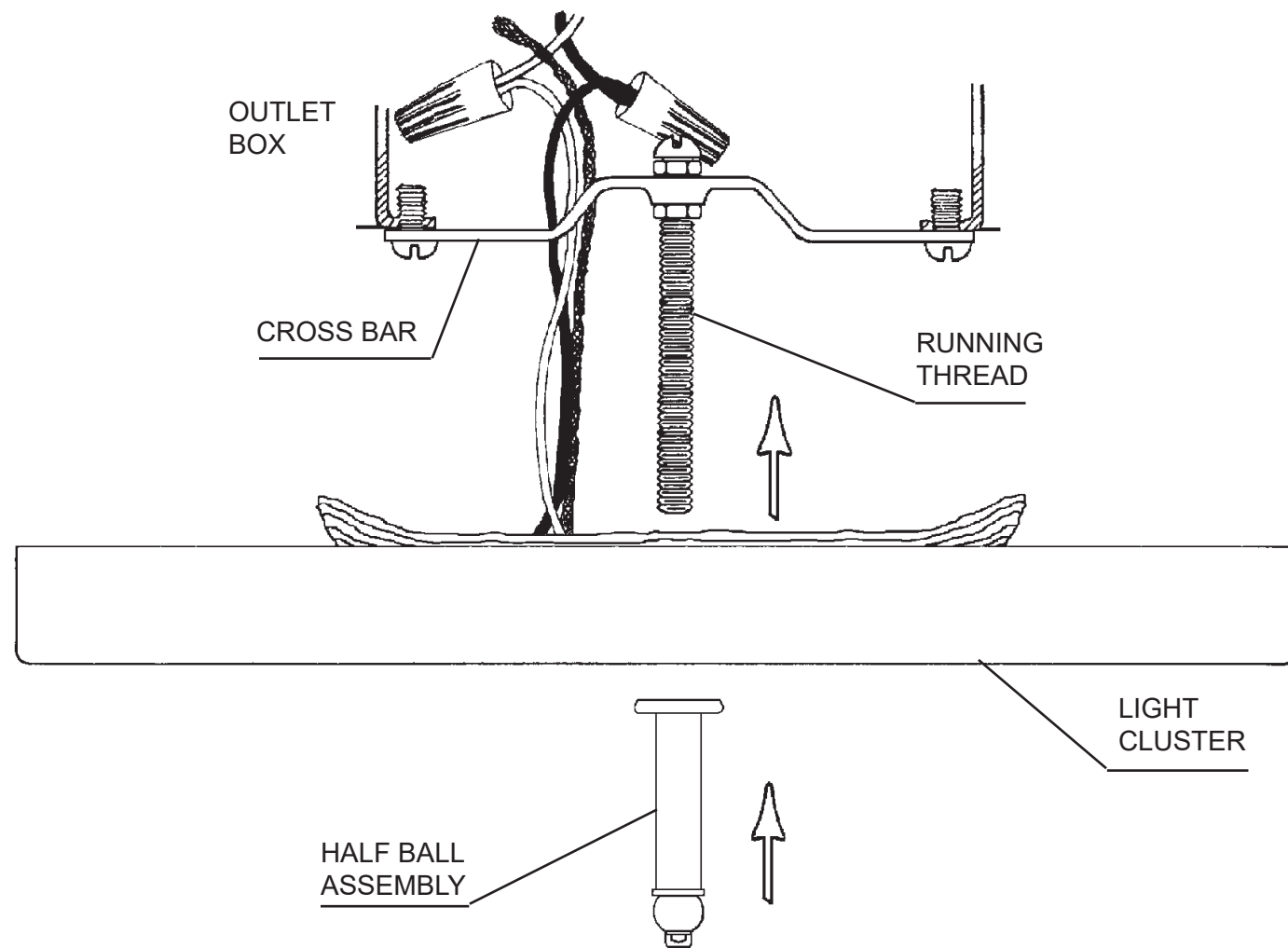

- 1** Remove crossbar from light cluster and attach to outlet box.
- 2** Feed stem wires through crossbar and attach to power wires in outlet box.
- 3** Place light cluster over thread attached to crossbar and secure with half ball assembly.

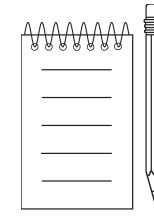



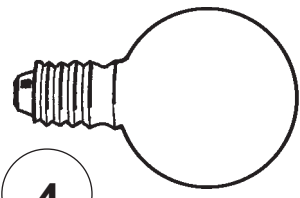

4

You will need 13 - G16-1/2
25 Watts Recommended
25 Watts Max
MIN 75°C SUPPLY
CONDUCTORS

Install bulbs and be sure to
test fixture **BEFORE**
trimming.

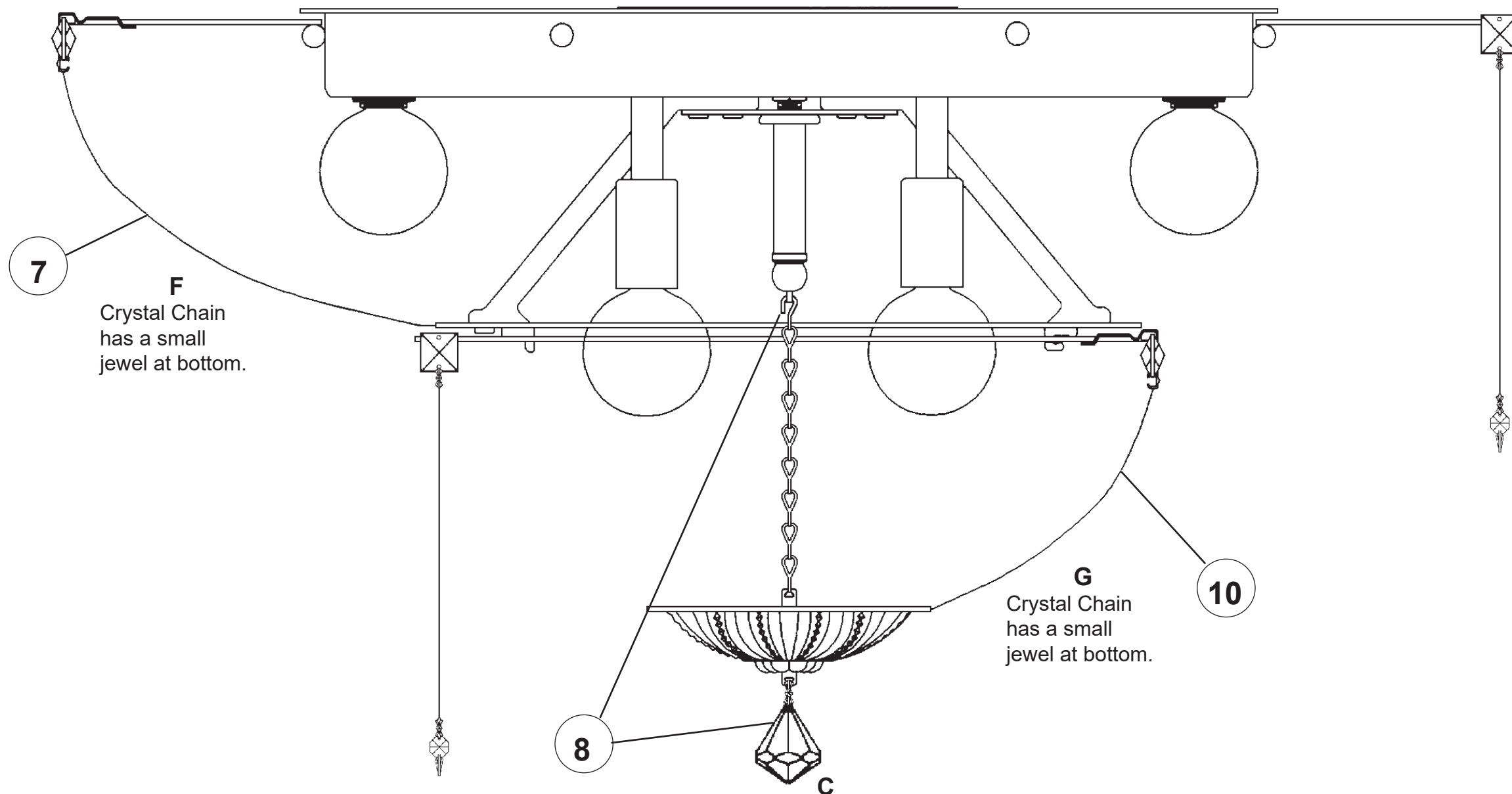

7

F
Crystal Chain
has a small
jewel at bottom.

8

C

G

Crystal Chain
has a small
jewel at bottom.

10

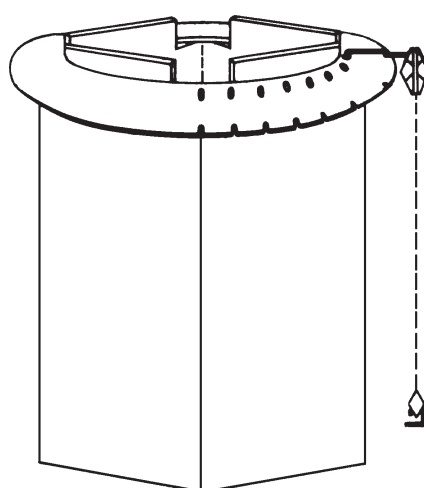

5 Hang upper gallery Chains "F" **FIRST!** Set mirror plate on cardboard stand. Hook all Crystal Chains "F" into slots in the mirror plate so the metal accessories face outwards and the square jewel is on the upper end. See illustrations #1 - #3. NOTE: Allow ends with small jewels to hang loose.

9 Hang lower gallery Chains "G" **SECOND!** Turn cardboard stand over that was used for Chains "F" (notches on bottom and squeeze into a long diamond shape) and then set lower mirror plate on cardboard stand. Hook all Chains "G" into slots in the lower mirror plate so that the metal accessories face outwards and square jewel is on the upper end. (See illustrations #1 - #3.) NOTE: Allow ends with small jewels to hang loose.

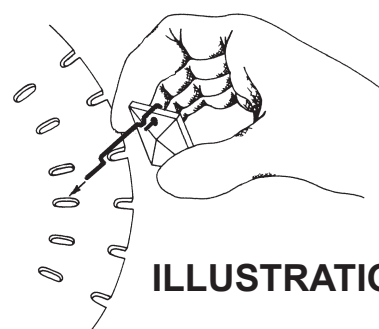

ILLUSTRATION 1

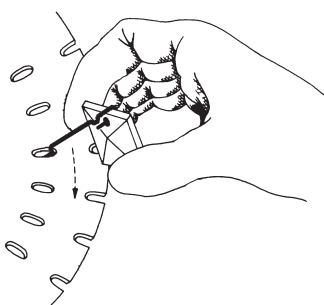

ILLUSTRATION 2

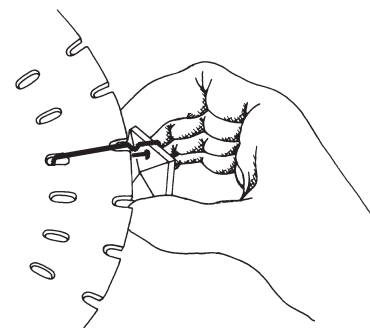

ILLUSTRATION 3

ILLUSTRATION 4

MOUNTING
POINTS

LIGHT
CLUSTER

MIRROR
PLATE

6 Align holes in mirror plate with the balls on the frame, raise mirror plate over balls, then turn mirror clockwise until holes are halfway between balls. See illustration #4.