

RENAISSANCE 3573- _____

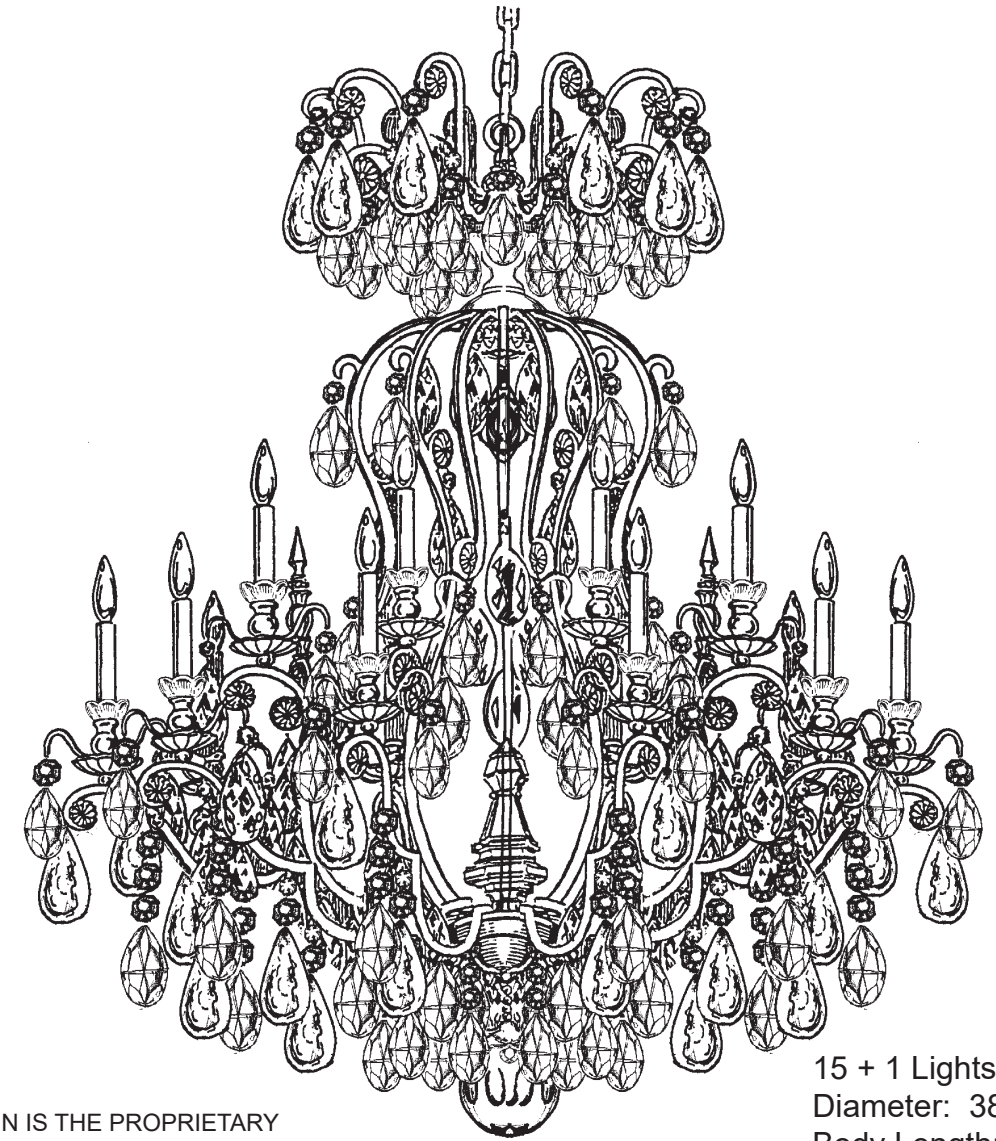











15 + 1 Lights
Diameter: 38"
Body Length: 44"
Hanging Weight: 80 lbs.

THIS DESIGN IS THE PROPRIETARY
TRADE DRESS/TRADEMARK OF
W SCHONBEK LLC.

 **SCHONBEK** | 1870

 **SCHONBEK** | 1870

								
MAX 60 W	MAX 15 W	110-120 V						

All electrical components must be installed by a licensed electrician in accordance with the National Electric Code and the appropriate local electrical codes.

WARNING: THIS LUMINAIRE MUST BE MOUNTED OR SUPPORTED INDEPENDENTLY OF AN OUTLET BOX.

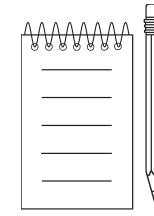
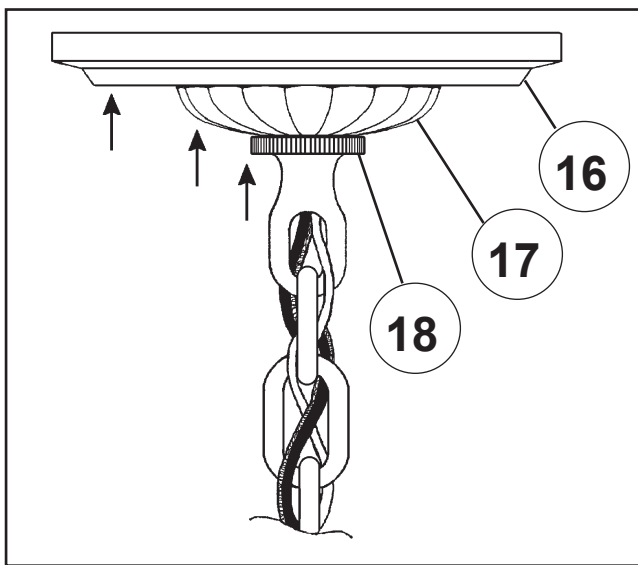
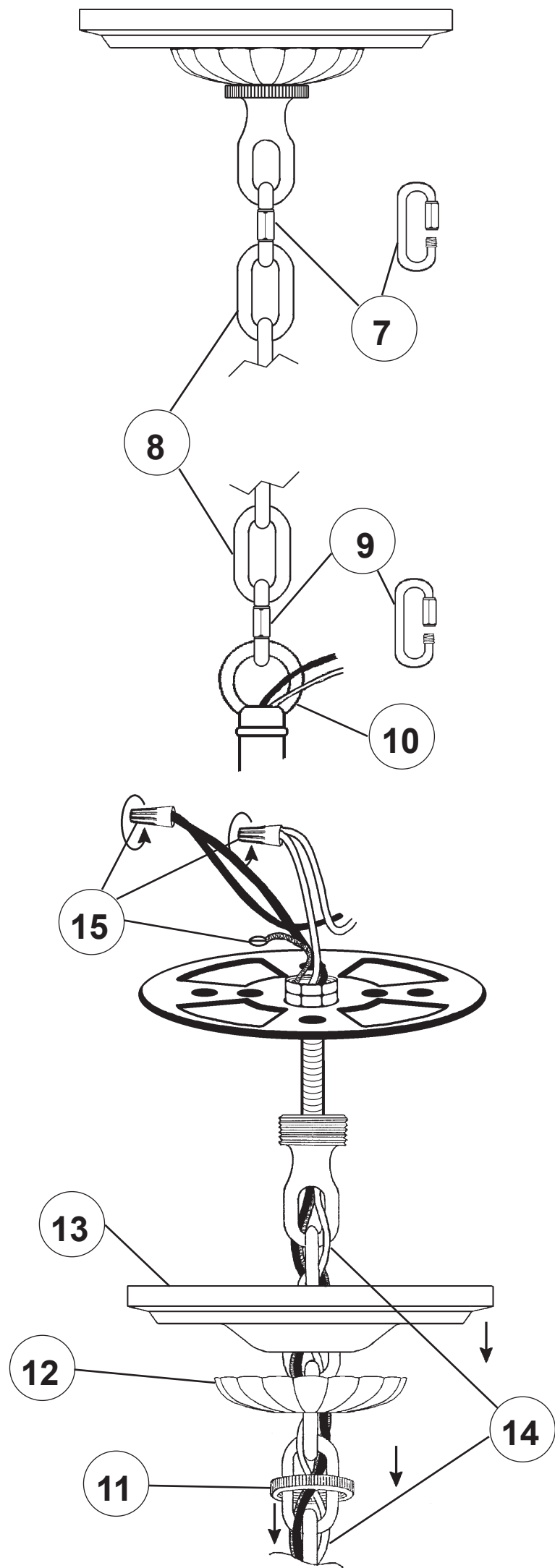
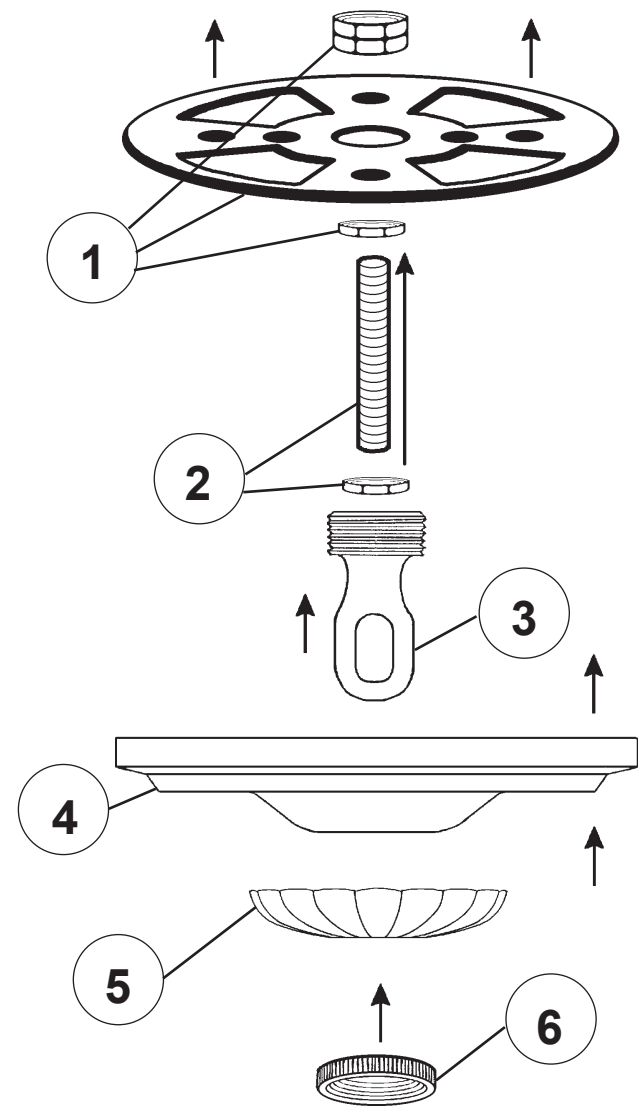

Crystal Set 3 in Black

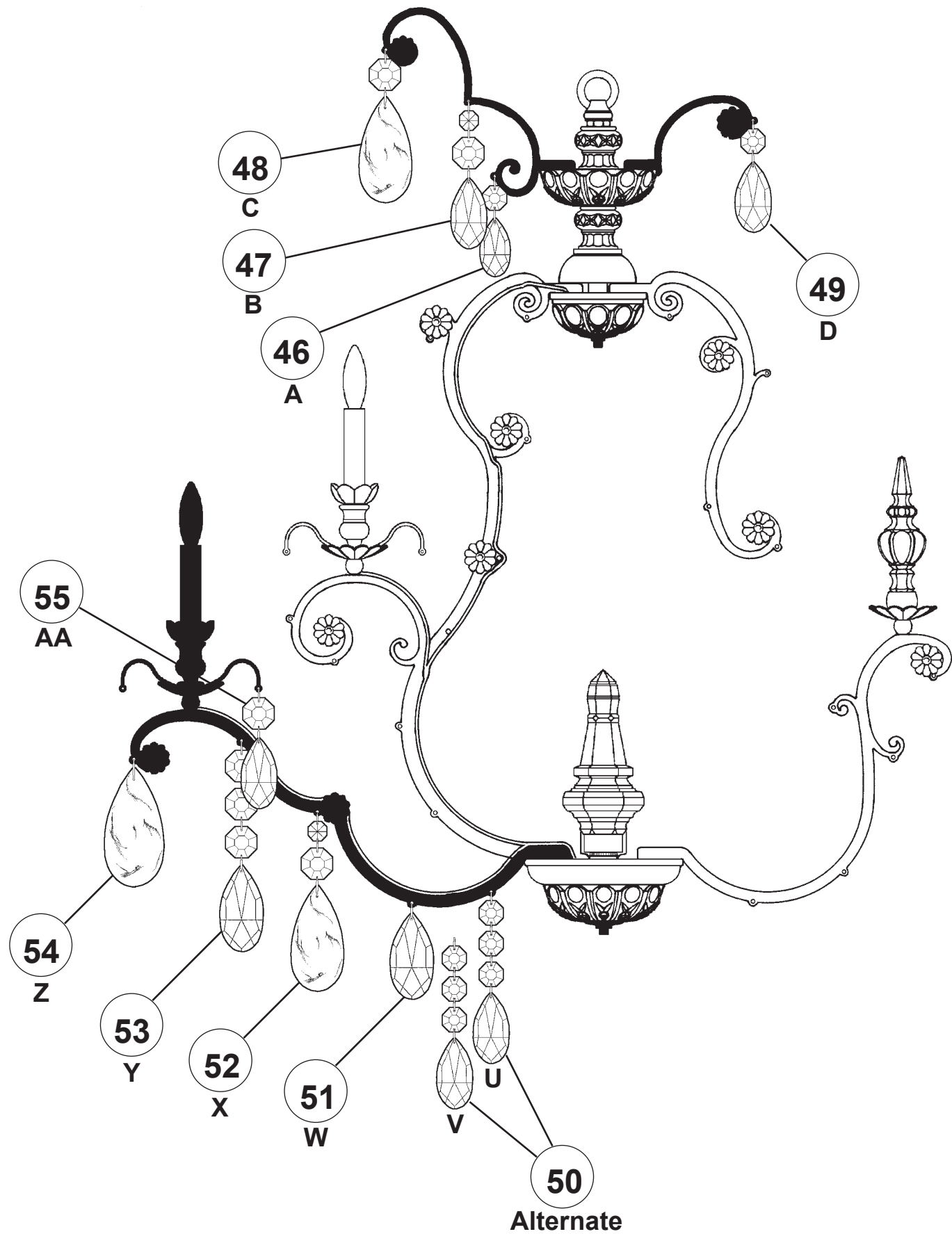

SET 1

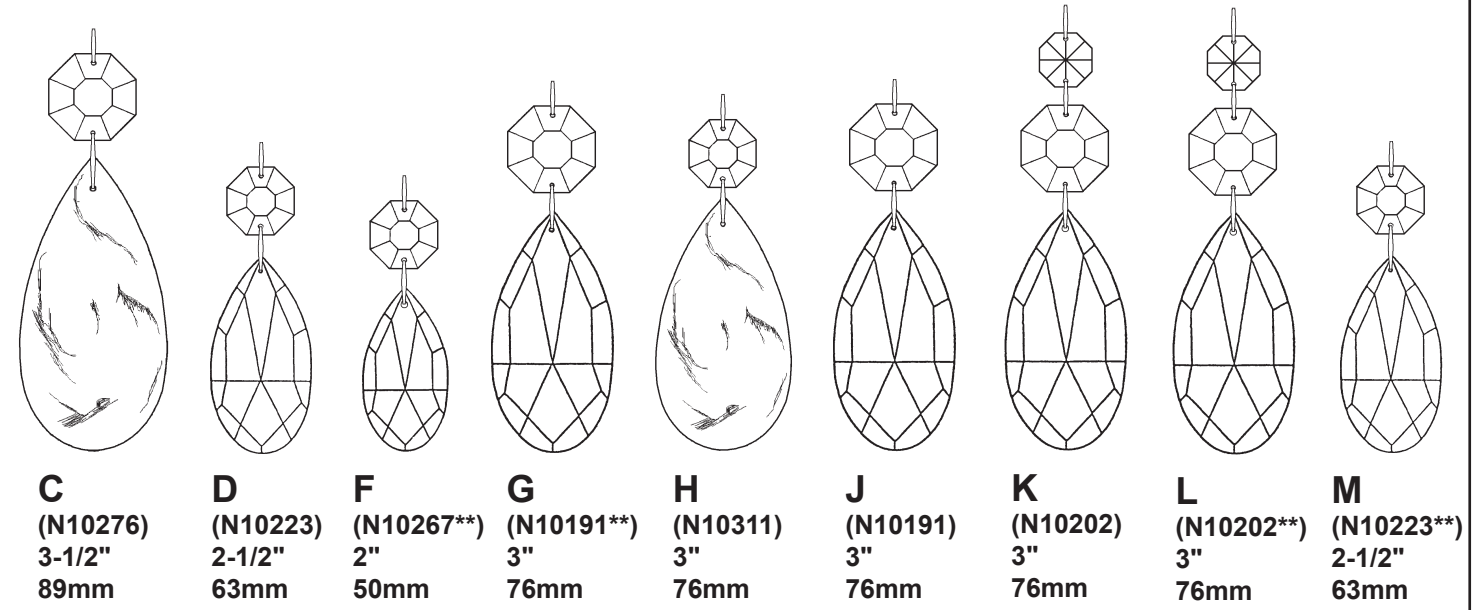

SET 2

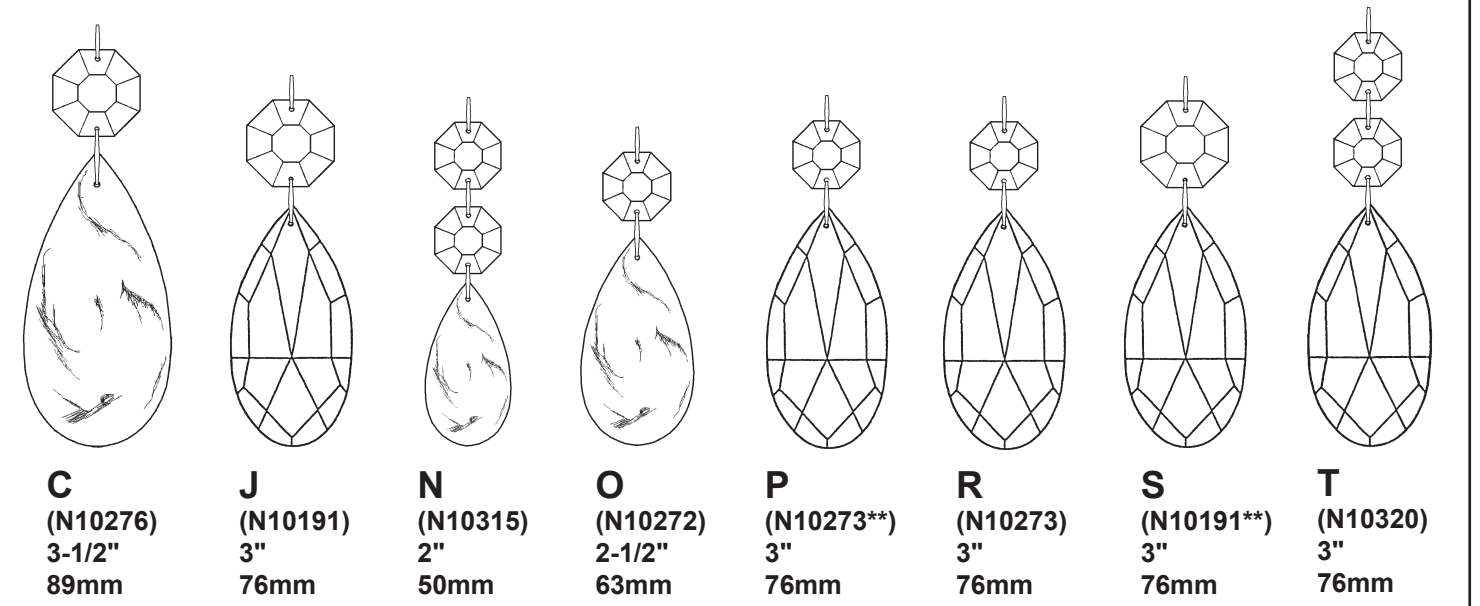

SET 3

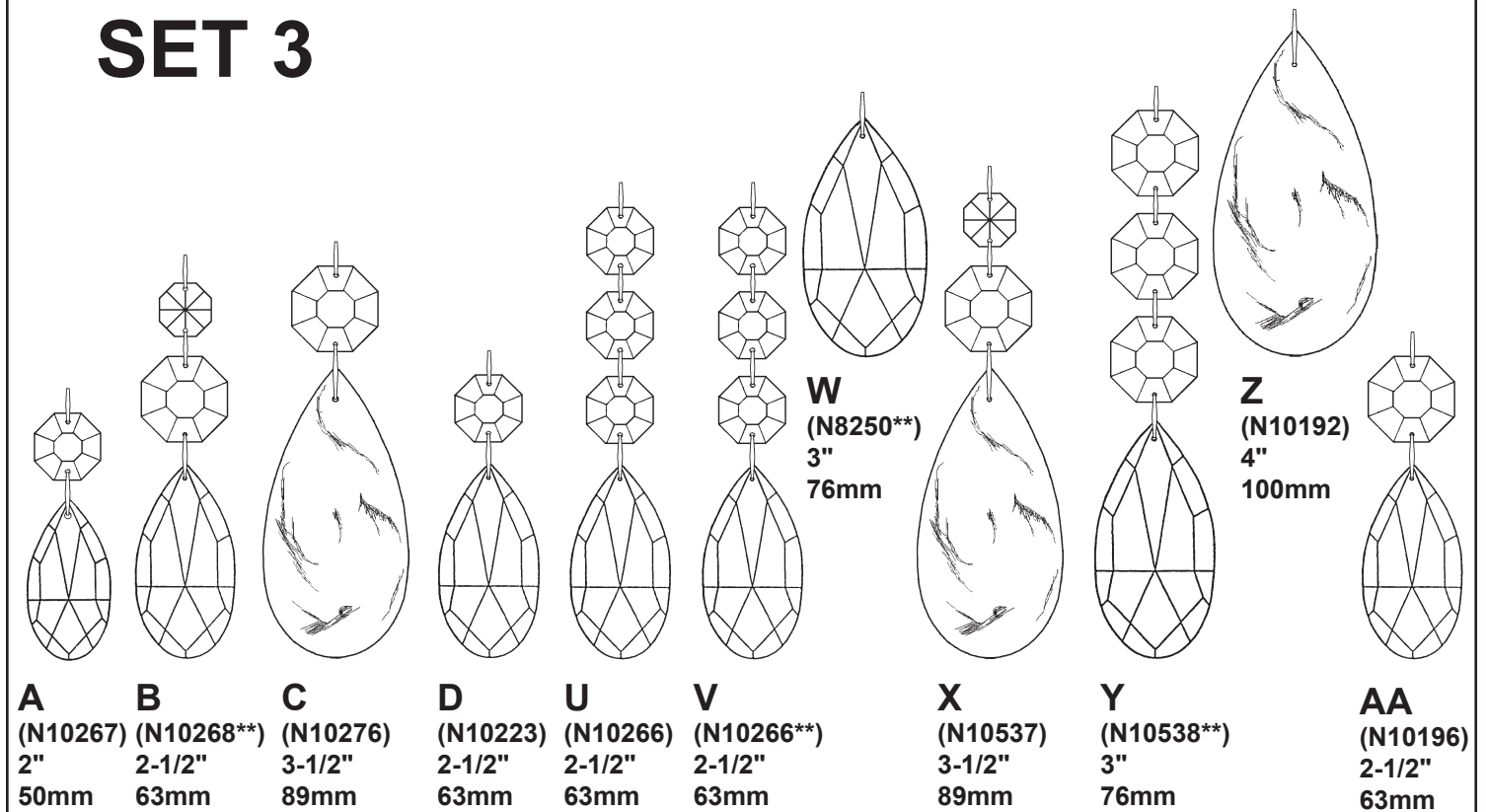

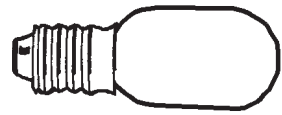

You will need 1 - T7
15 Watts Max
(Center Light)

20

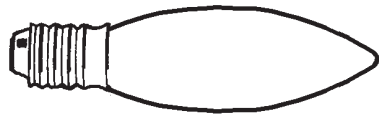

You will need 15 - B10
25 Watts Recommended
60 Watts Max

Install bulbs and be sure
to test fixture **BEFORE**
trimming.

Crystal Set 1 in Black

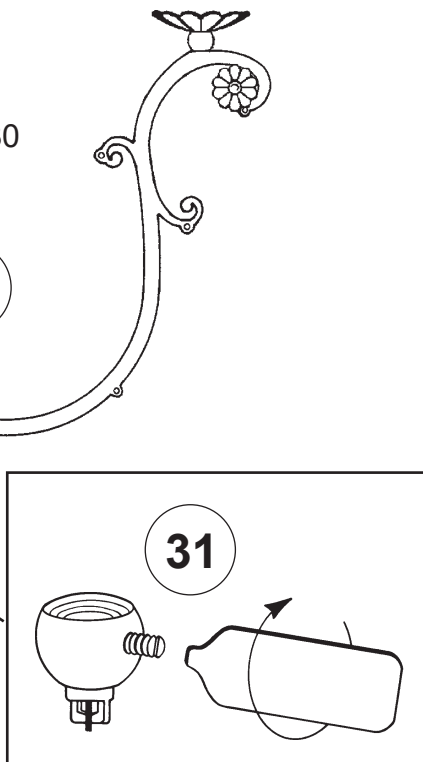
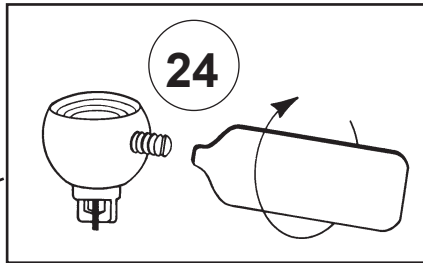
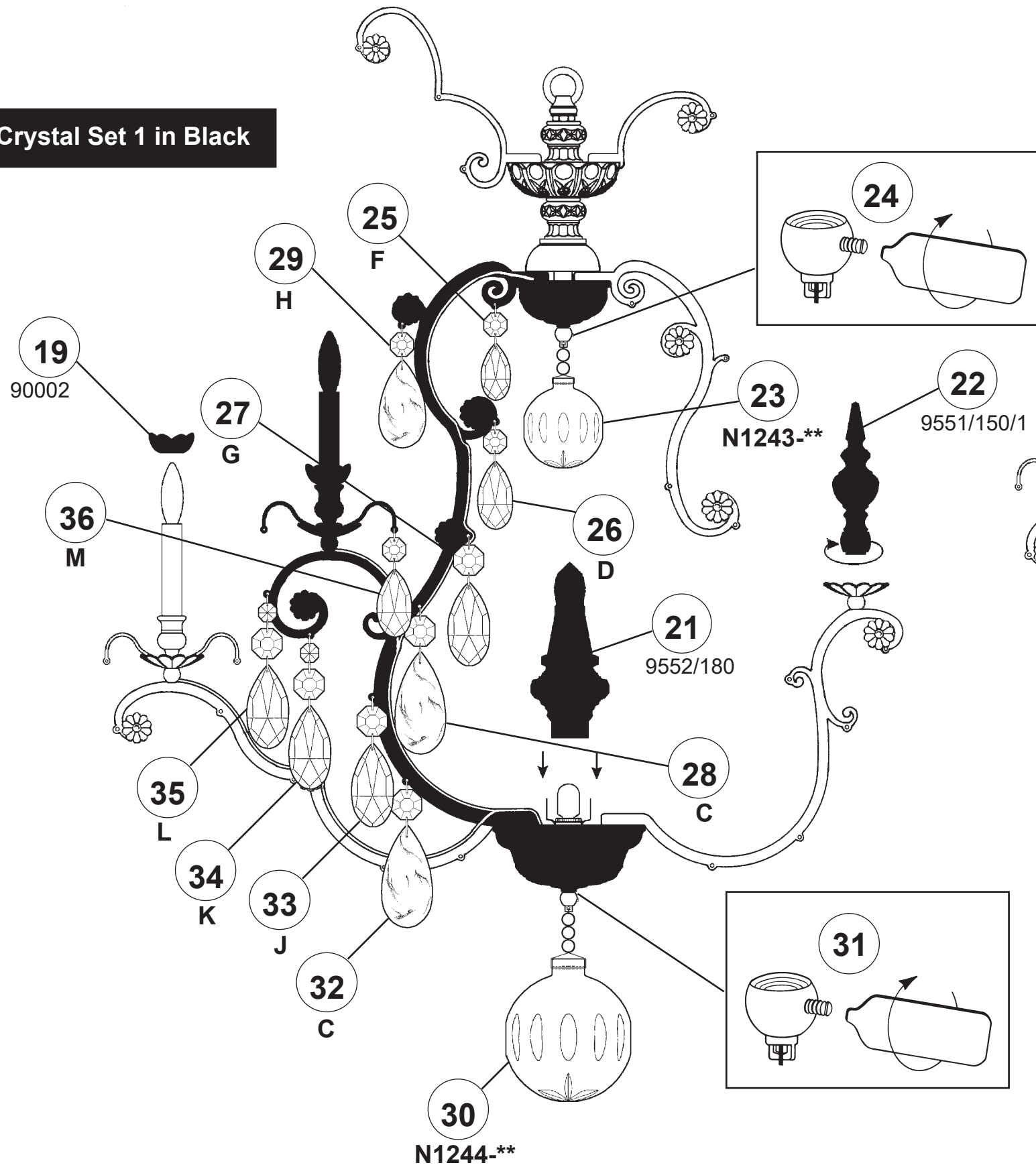

Crystal Set 2 in Black

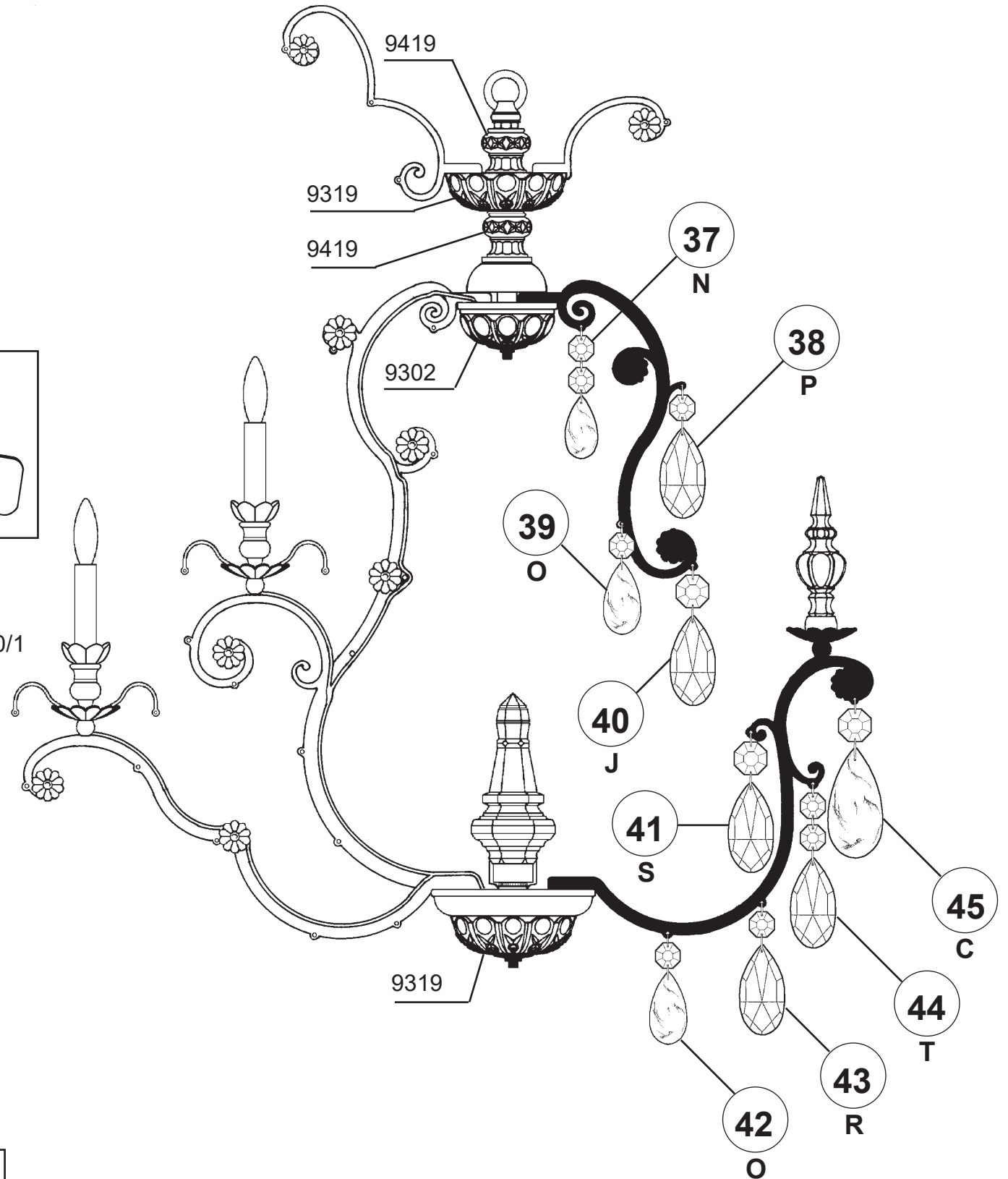

RENAISSANCE 3573- _____

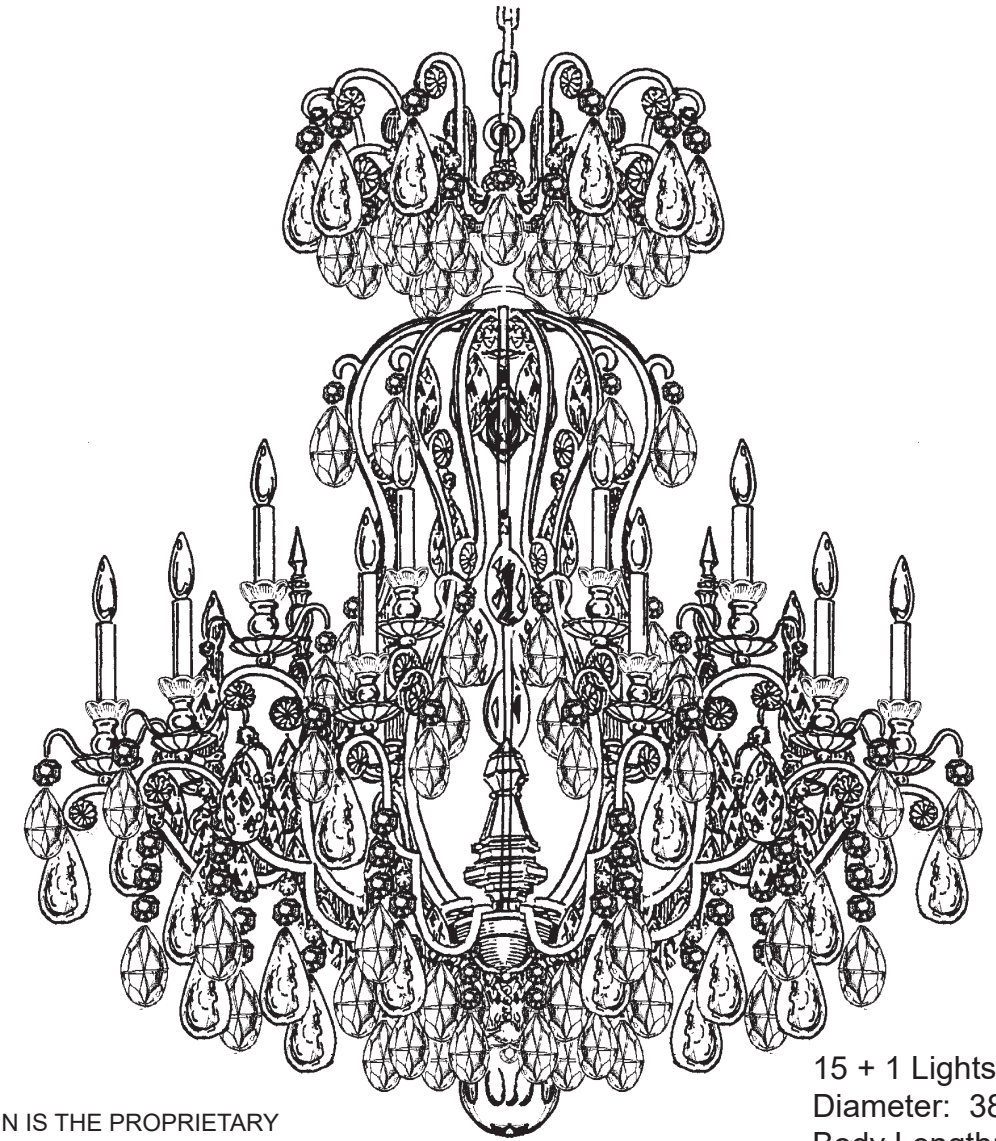











15 + 1 Lights
Diameter: 38"
Body Length: 44"
Hanging Weight: 80 lbs.

THIS DESIGN IS THE PROPRIETARY
TRADE DRESS/TRADEMARK OF
W SCHONBEK LLC.

 **SCHONBEK** | 1870

 **SCHONBEK** | 1870

								
MAX 60 W	MAX 15 W	110-120 V						

All electrical components must be installed by a licensed electrician in accordance with the National Electric Code and the appropriate local electrical codes.



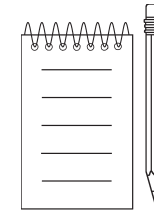
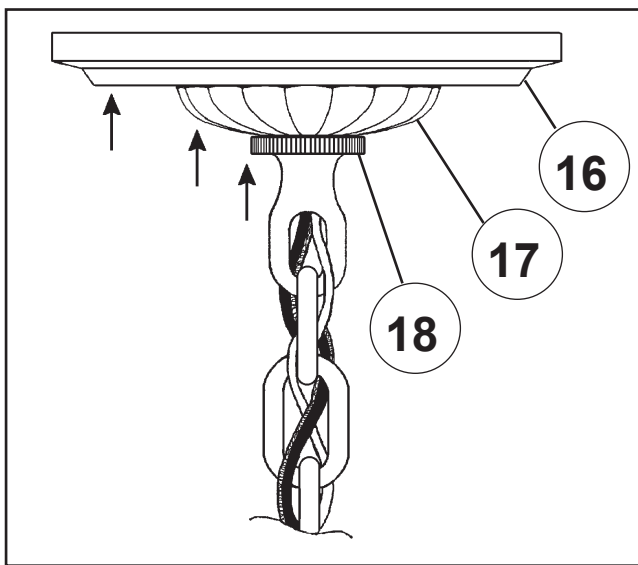
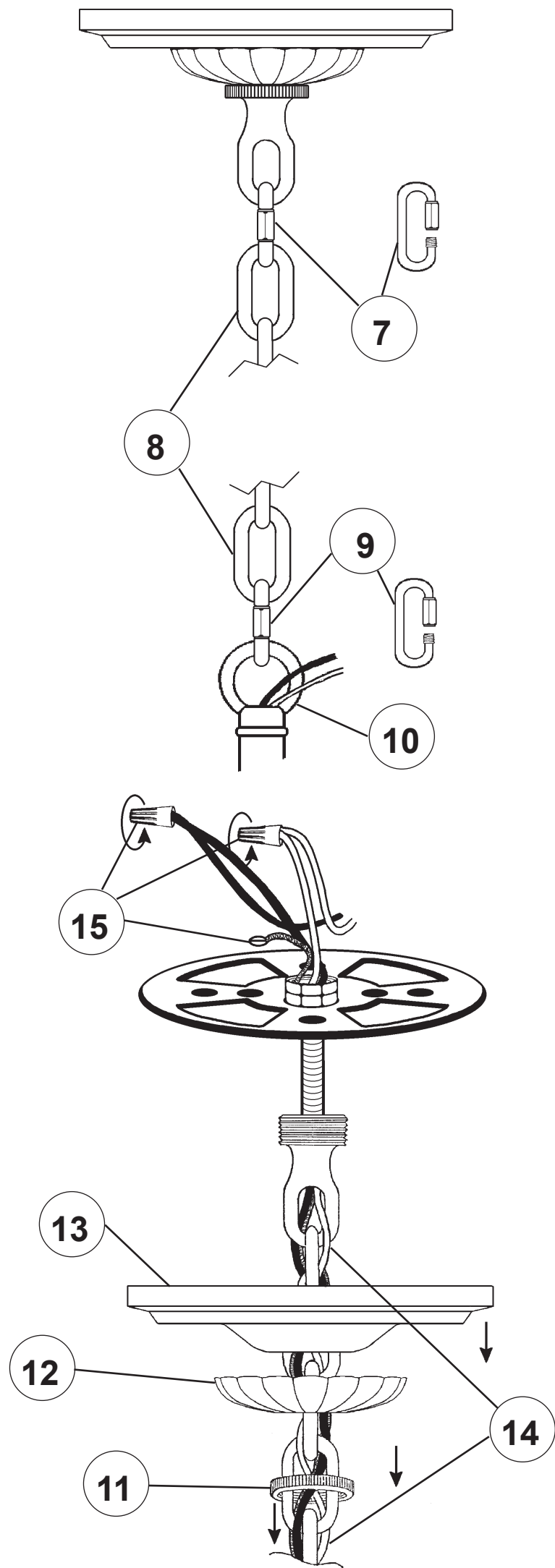
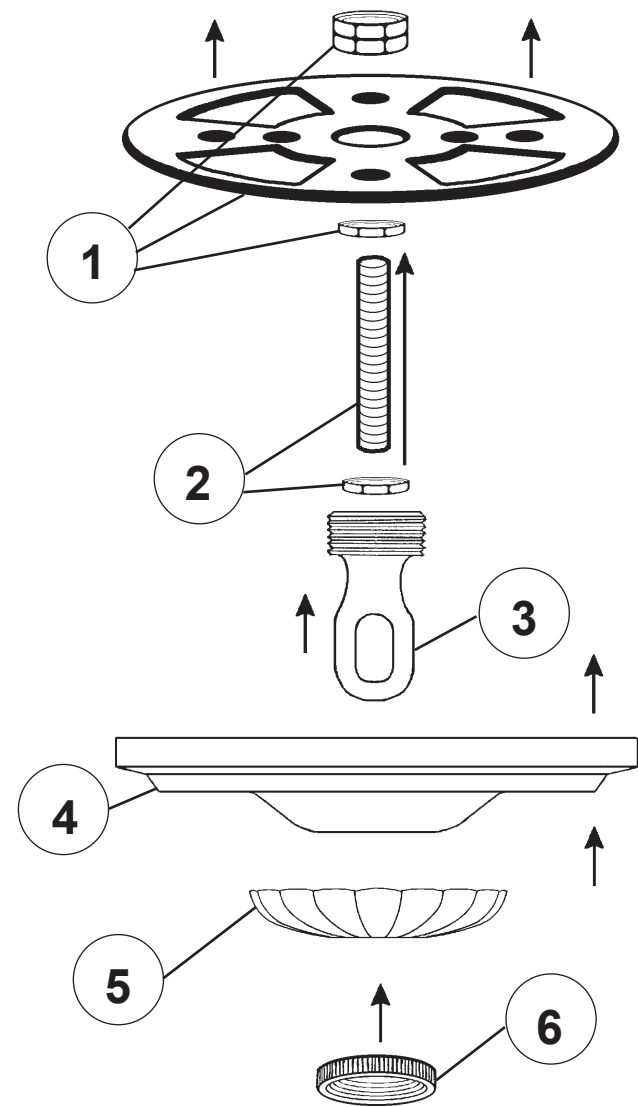

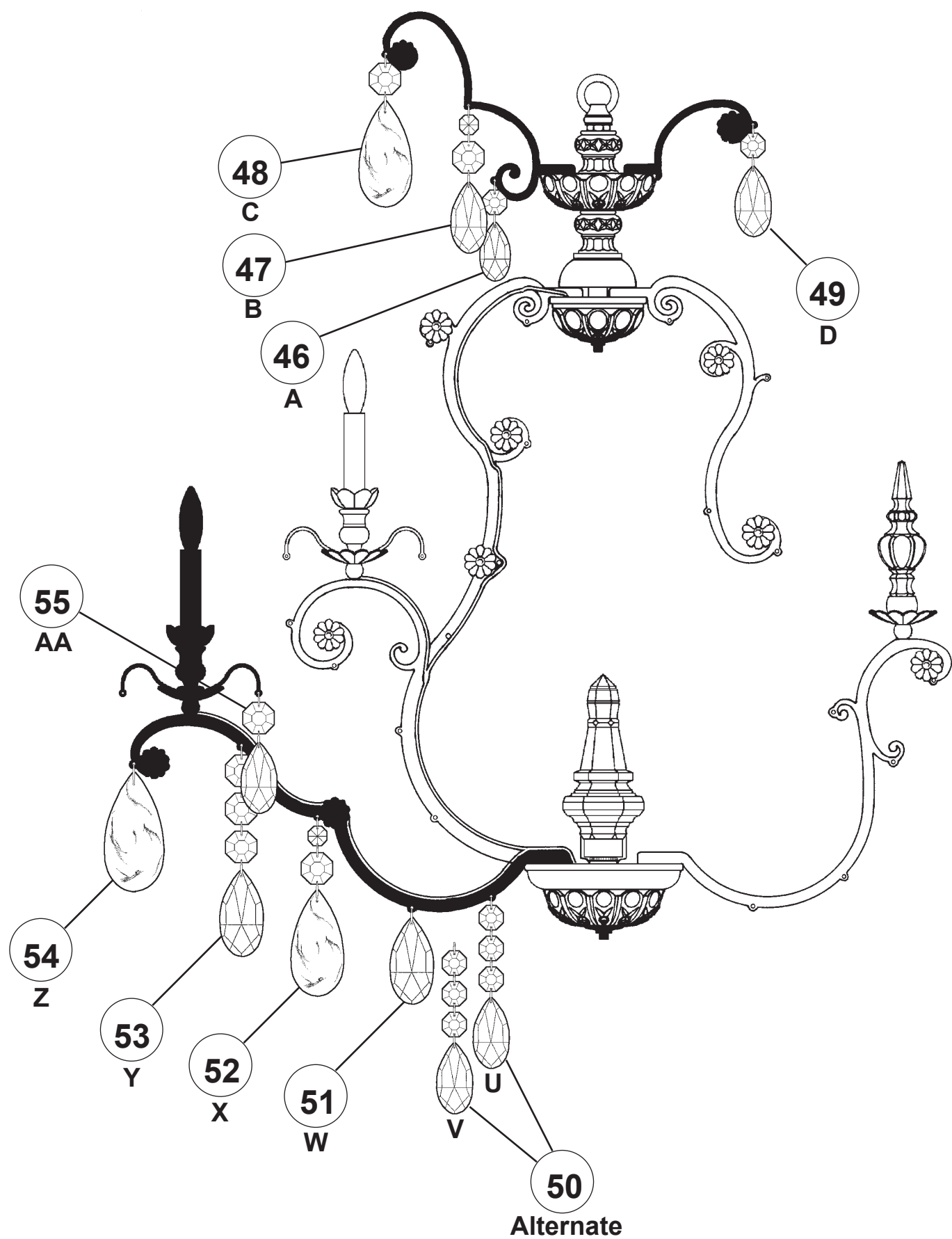

WARNING: THIS LUMINAIRE MUST BE MOUNTED OR SUPPORTED INDEPENDENTLY OF AN OUTLET BOX.

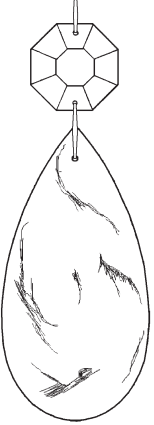

Crystal Set 3 in Black



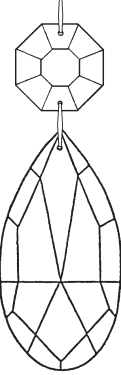
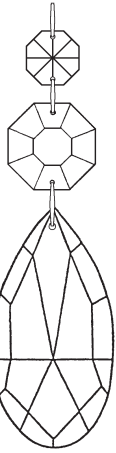
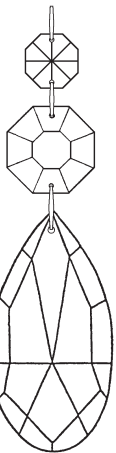



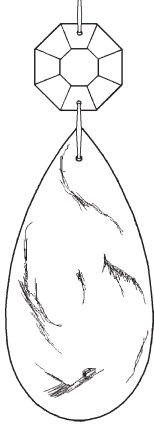
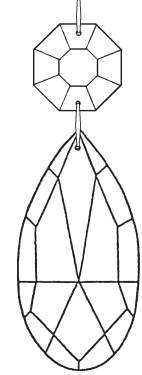
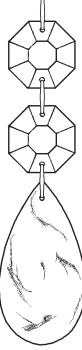
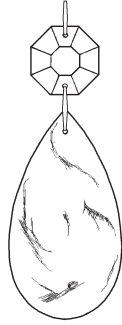
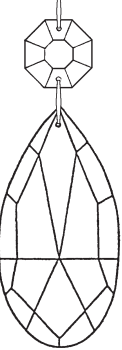
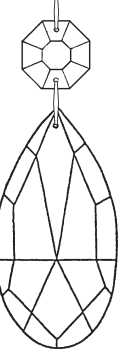
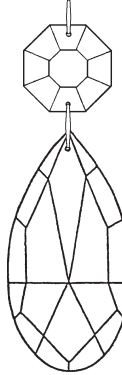
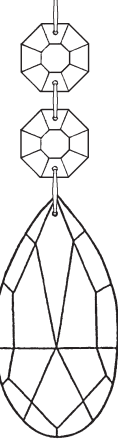

SET 1

								
C (N10276) 3-1/2" 89mm	D (N10223) 2-1/2" 63mm	F (N10267**) 2" 50mm	G (N10191**) 3" 76mm	H (N10311) 3" 76mm	J (N10191) 3" 76mm	K (N10202) 3" 76mm	L (N10202**) 3" 76mm	M (N10223**) 2-1/2" 63mm

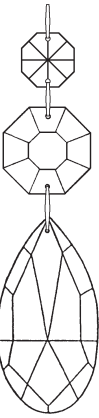
SET 2

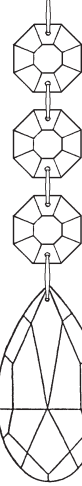
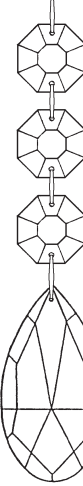
							
C (N10276) 3-1/2" 89mm	J (N10191) 3" 76mm	N (N10315) 2" 50mm	O (N10272) 2-1/2" 63mm	P (N10273**) 3" 76mm	R (N10273) 3" 76mm	S (N10191**) 3" 76mm	T (N10320) 3" 76mm

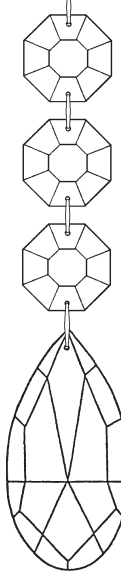
SET 3

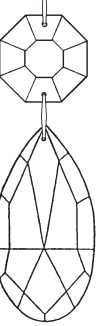
										
A (N10267) 2" 50mm	B (N10268**) 2-1/2" 63mm	C (N10276) 3-1/2" 89mm	D (N10223) 2-1/2" 63mm	U (N10266) 2-1/2" 63mm	V (N10266**) 2-1/2" 63mm	W (N8250**) 3" 76mm	X (N10537) 3-1/2" 89mm	Y (N10538**) 3" 76mm	Z (N10192) 4" 100mm	AA (N10196) 2-1/2" 63mm

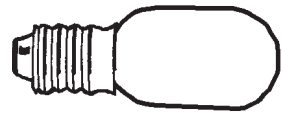

You will need 1 - T7
15 Watts Max
(Center Light)

20



You will need 15 - B10
25 Watts Recommended
60 Watts Max

Install bulbs and be sure
to test fixture **BEFORE**
trimming.

Crystal Set 1 in Black

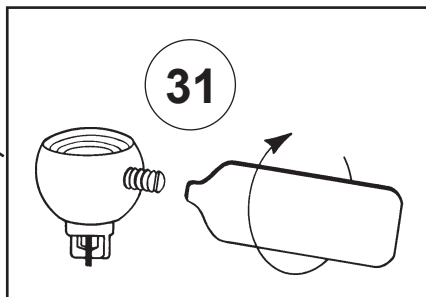
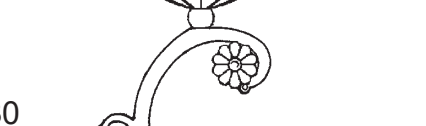
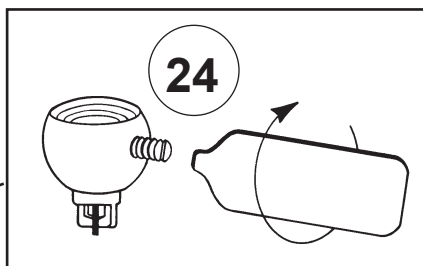
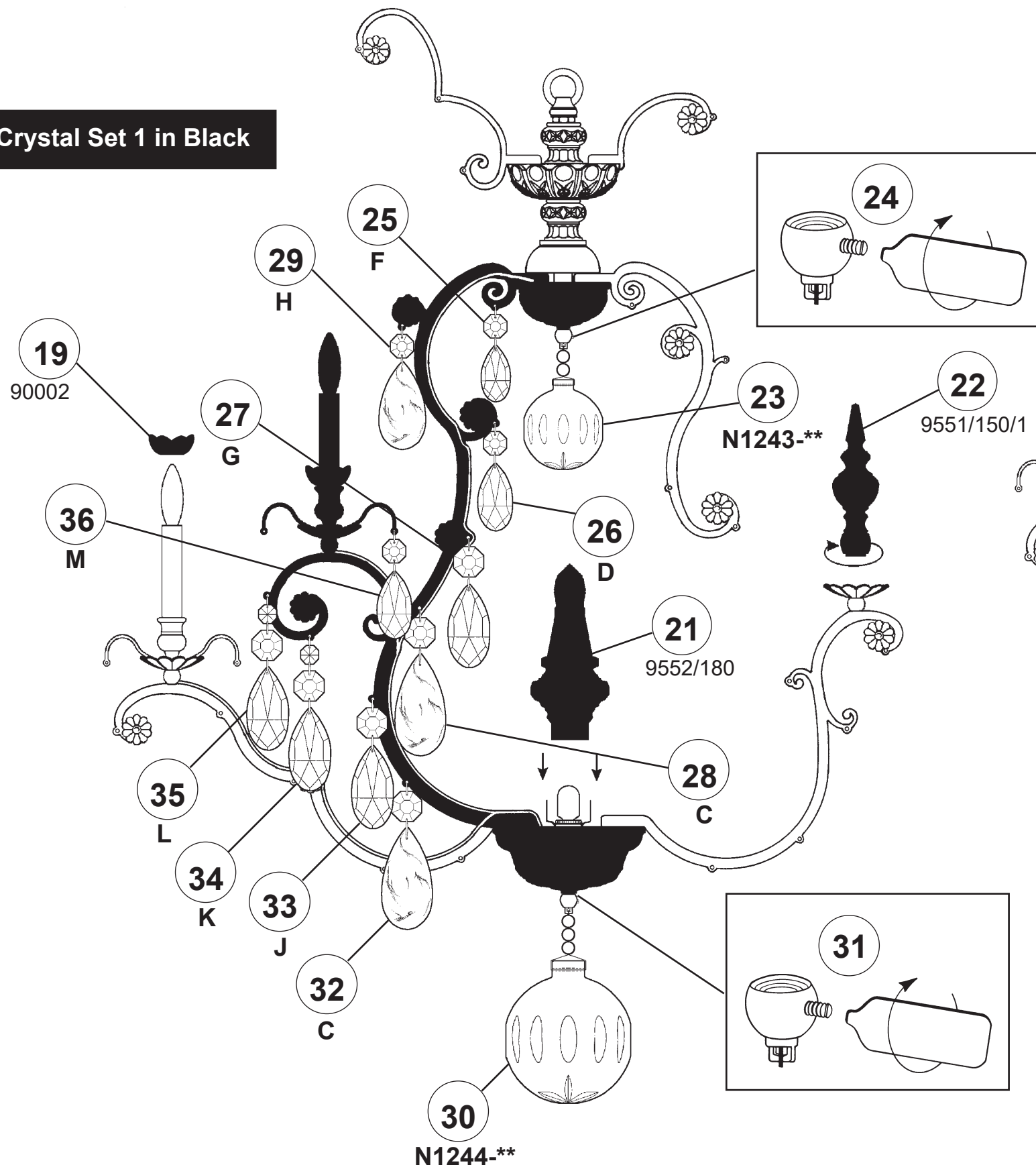

Crystal Set 2 in Black

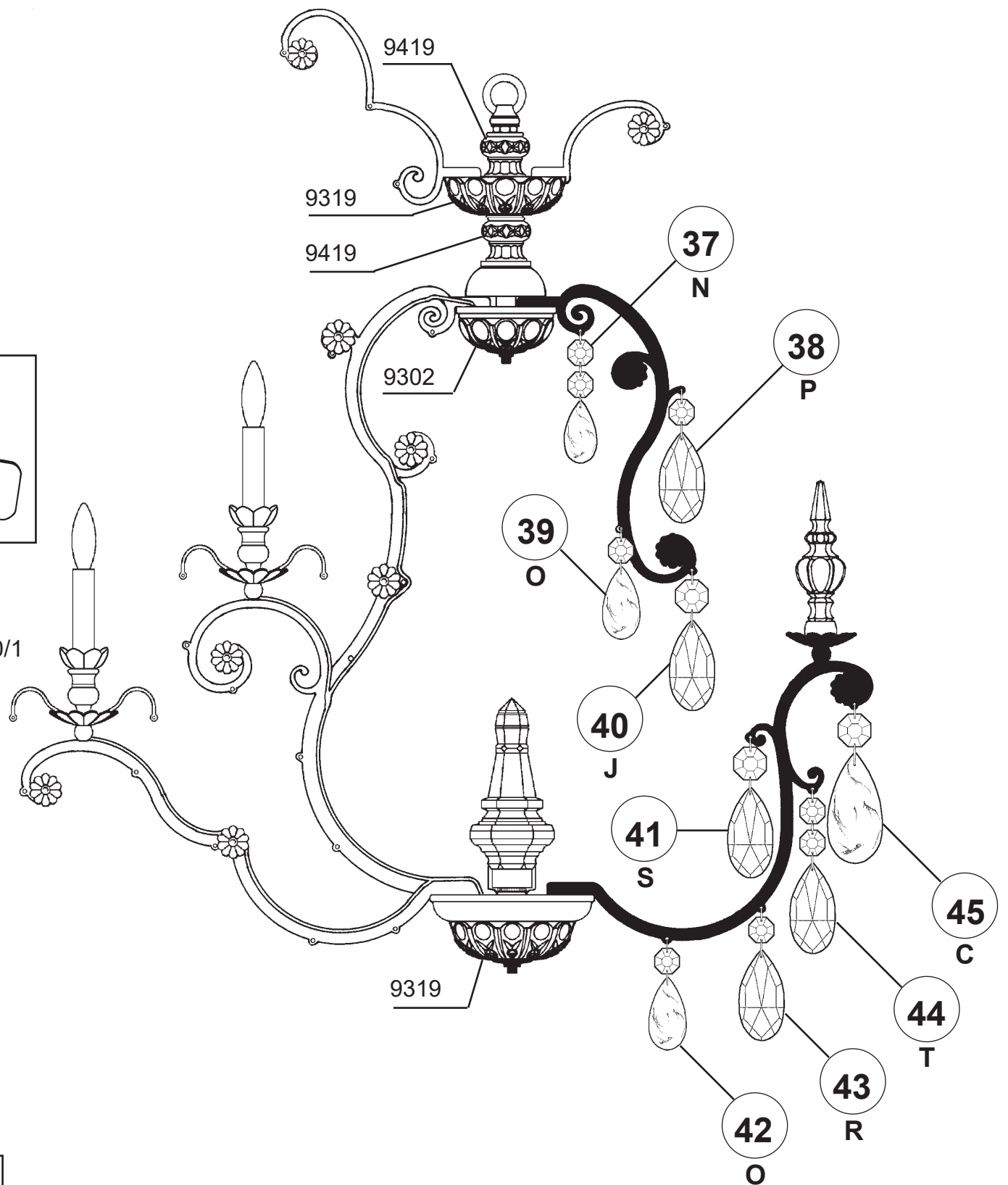

RENAISSANCE 3573- _____

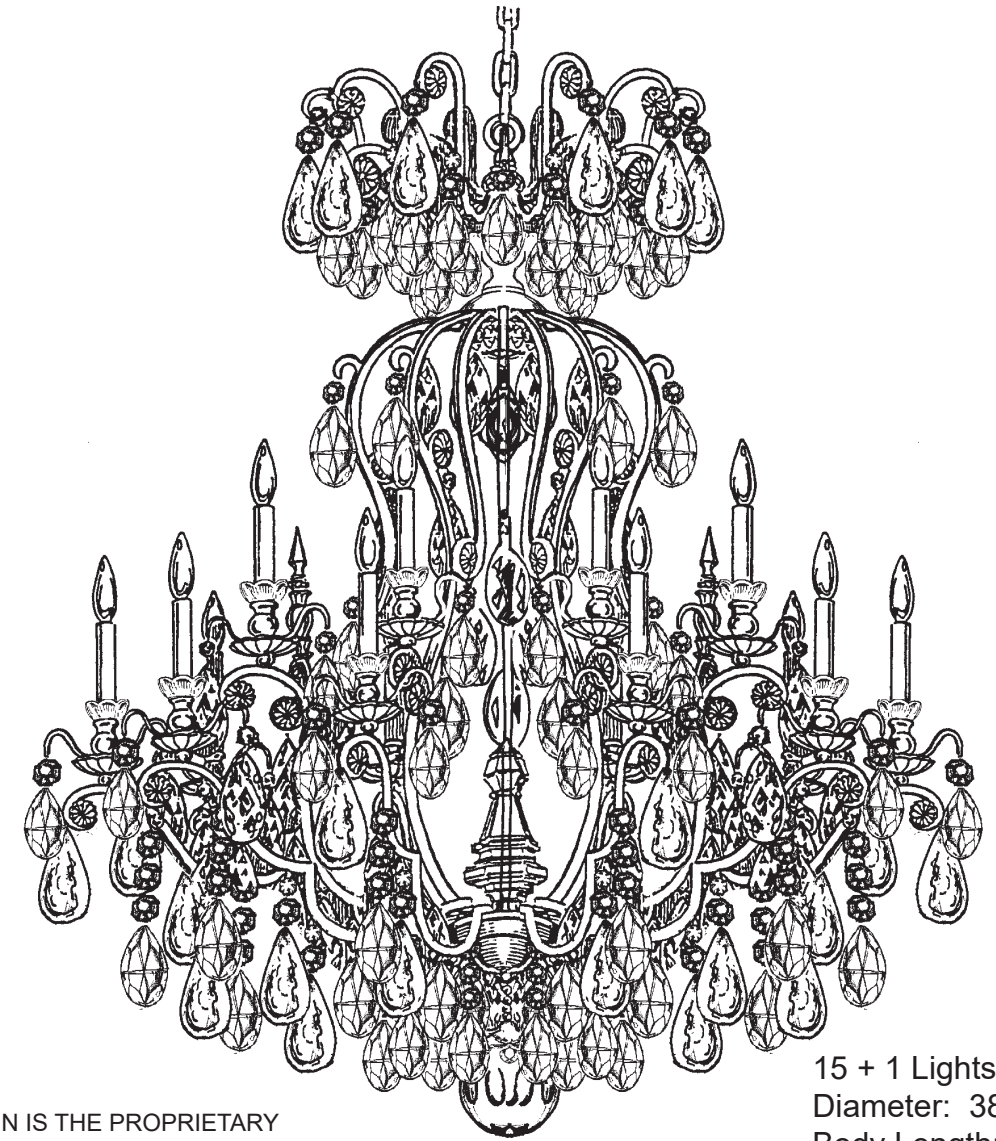











15 + 1 Lights
Diameter: 38"
Body Length: 44"
Hanging Weight: 80 lbs.

THIS DESIGN IS THE PROPRIETARY
TRADE DRESS/TRADEMARK OF
W SCHONBEK LLC.

 **SCHONBEK** | 1870

 **SCHONBEK** | 1870

								
MAX 60 W	MAX 15 W	110-120 V						

All electrical components must be installed by a licensed electrician in accordance with the National Electric Code and the appropriate local electrical codes.



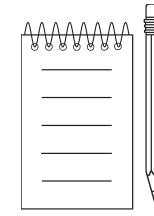
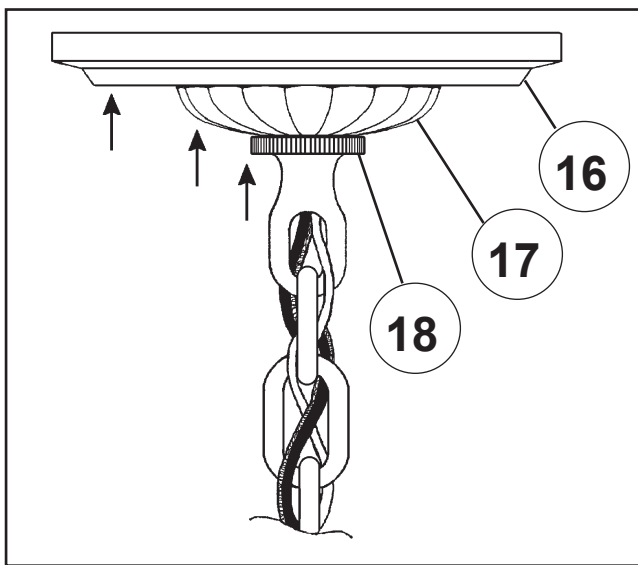
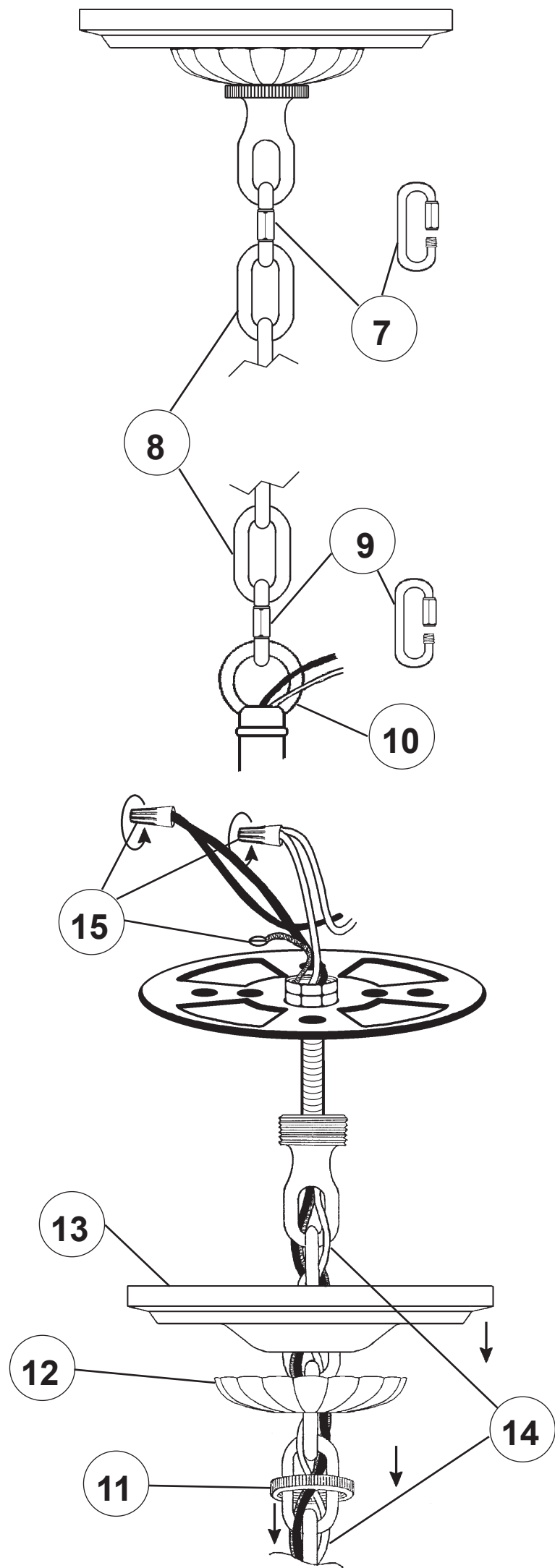
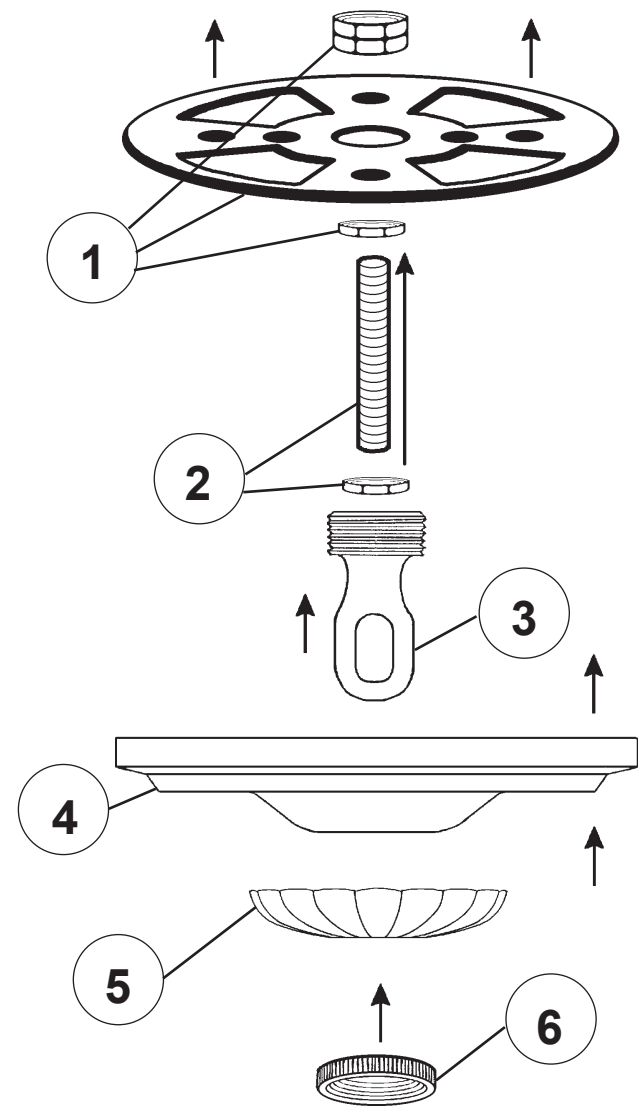

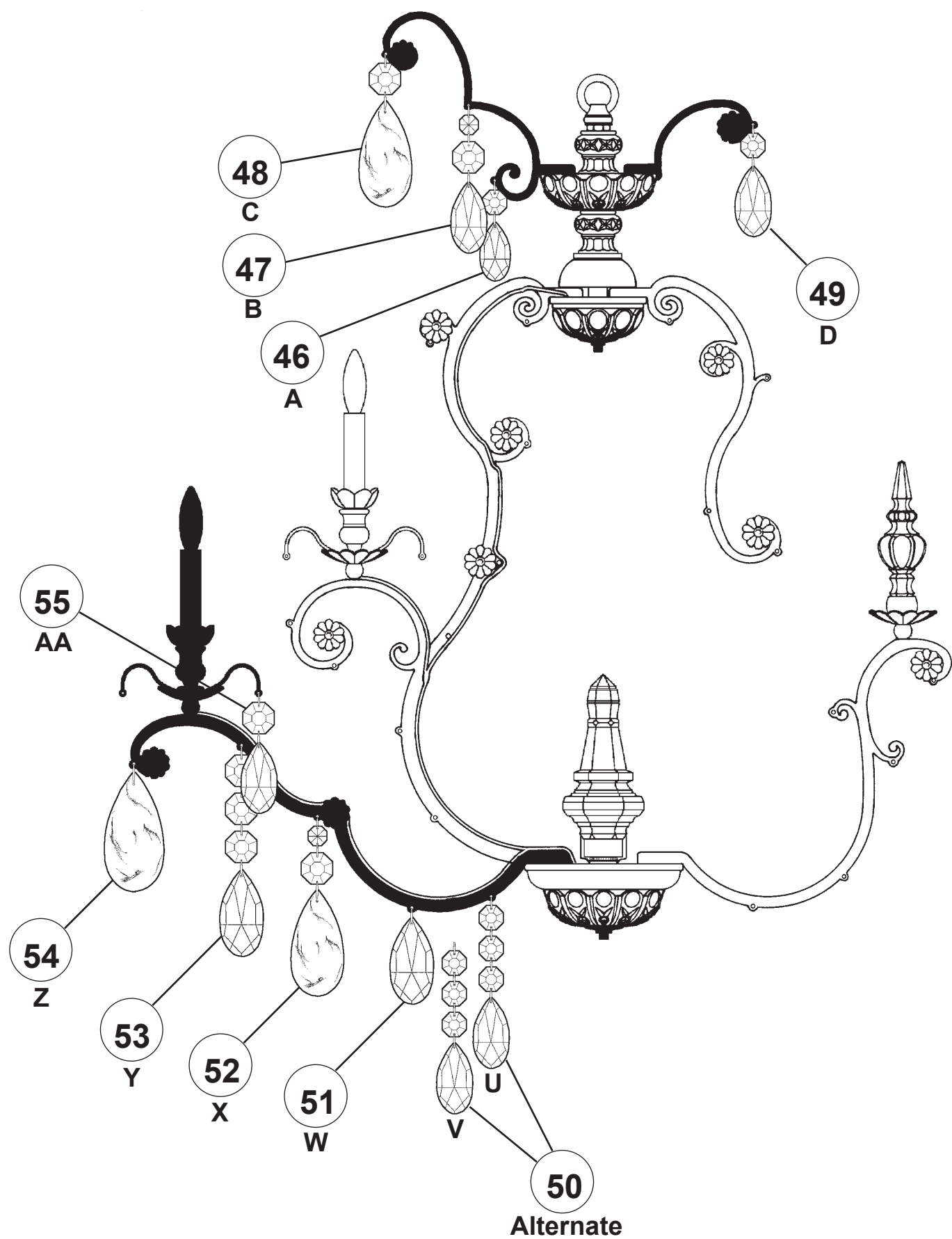

WARNING: THIS LUMINAIRE MUST BE MOUNTED OR SUPPORTED INDEPENDENTLY OF AN OUTLET BOX.

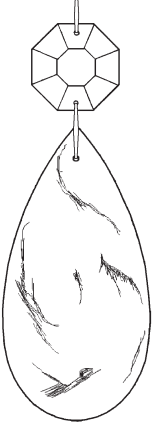

Crystal Set 3 in Black

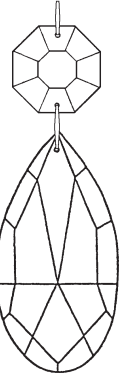

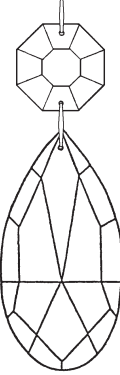
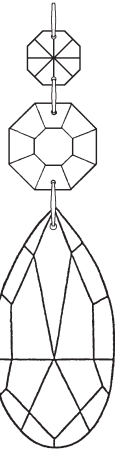
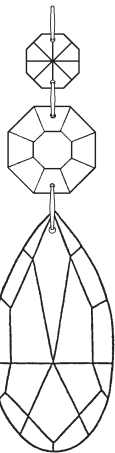



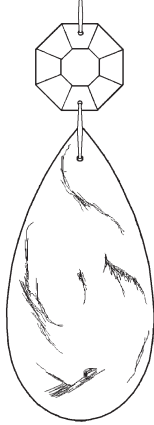
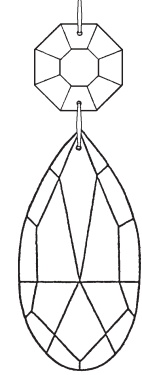
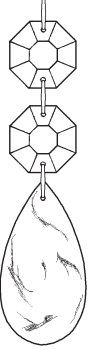
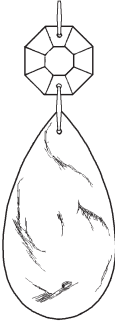
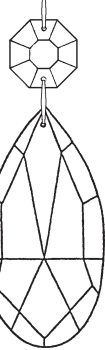
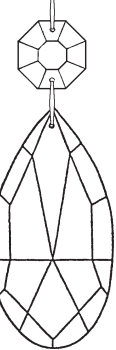
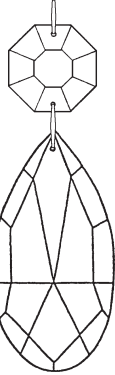
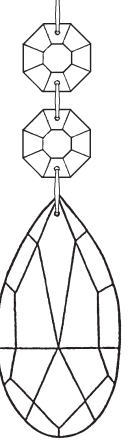

SET 1

								
C (N10276) 3-1/2" 89mm	D (N10223) 2-1/2" 63mm	F (N10267**) 2" 50mm	G (N10191**) 3" 76mm	H (N10311) 3" 76mm	J (N10191) 3" 76mm	K (N10202) 3" 76mm	L (N10202**) 3" 76mm	M (N10223**) 2-1/2" 63mm

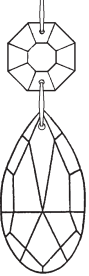
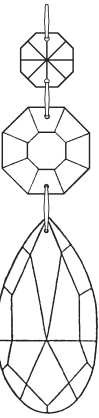
SET 2

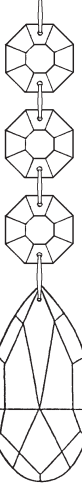
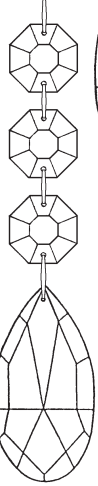
							
C (N10276) 3-1/2" 89mm	J (N10191) 3" 76mm	N (N10315) 2" 50mm	O (N10272) 2-1/2" 63mm	P (N10273**) 3" 76mm	R (N10273) 3" 76mm	S (N10191**) 3" 76mm	T (N10320) 3" 76mm

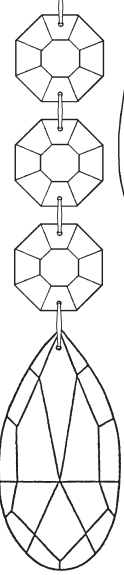
SET 3

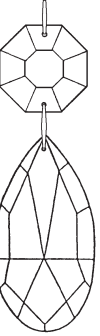
										
A (N10267) 2" 50mm	B (N10268**) 2-1/2" 63mm	C (N10276) 3-1/2" 89mm	D (N10223) 2-1/2" 63mm	U (N10266) 2-1/2" 63mm	V (N10266**) 2-1/2" 63mm	W (N8250**) 3" 76mm	X (N10537) 3-1/2" 89mm	Y (N10538**) 3" 76mm	Z (N10192) 4" 100mm	AA (N10196) 2-1/2" 63mm

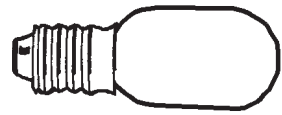

You will need 1 - T7
15 Watts Max
(Center Light)

20



You will need 15 - B10
25 Watts Recommended
60 Watts Max

Install bulbs and be sure
to test fixture **BEFORE**
trimming.

Crystal Set 1 in Black

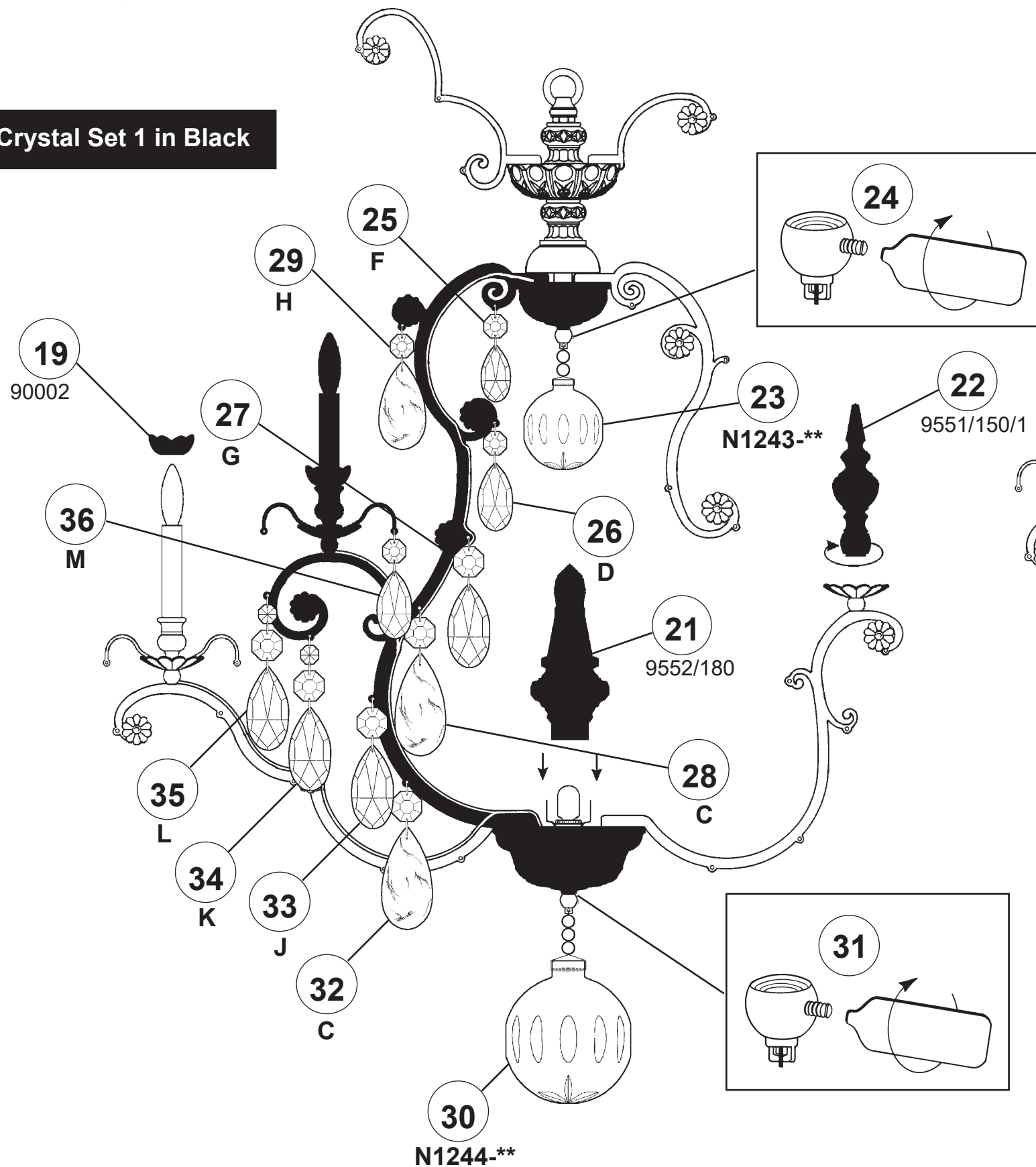

Crystal Set 2 in Black

