

STERLING 2992- \_\_\_ \_H

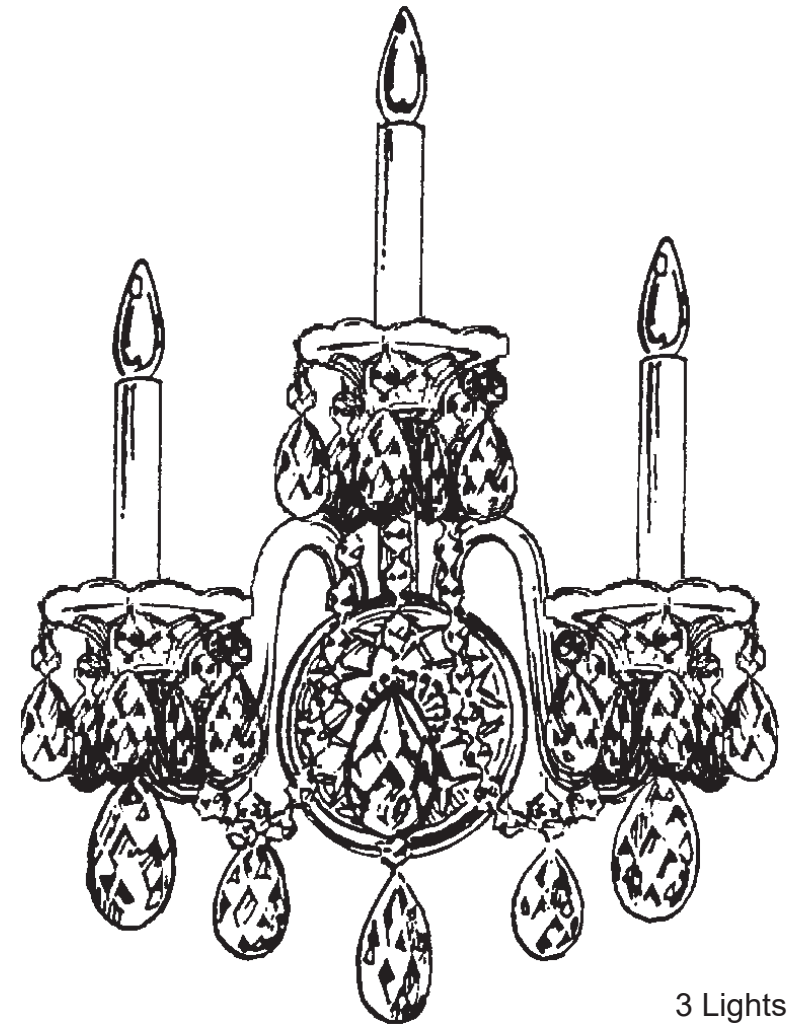











3 Lights  
Diameter: 15-1/2"  
Body Length: 21"  
Extension: 7-1/2"  
Hanging Weight: 5 lbs.

**T**HIS DESIGN IS THE PROPRIETARY  
TRADE DRESS/TRADEMARK OF  
W SCHONBEK LLC.

 **SCHONBEK** | 1870

 **SCHONBEK** | 1870

								
MAX <b>60</b> W	110-120 V							

All electrical components must be installed by a licensed electrician in accordance with the National Electric Code and the appropriate local electrical codes.

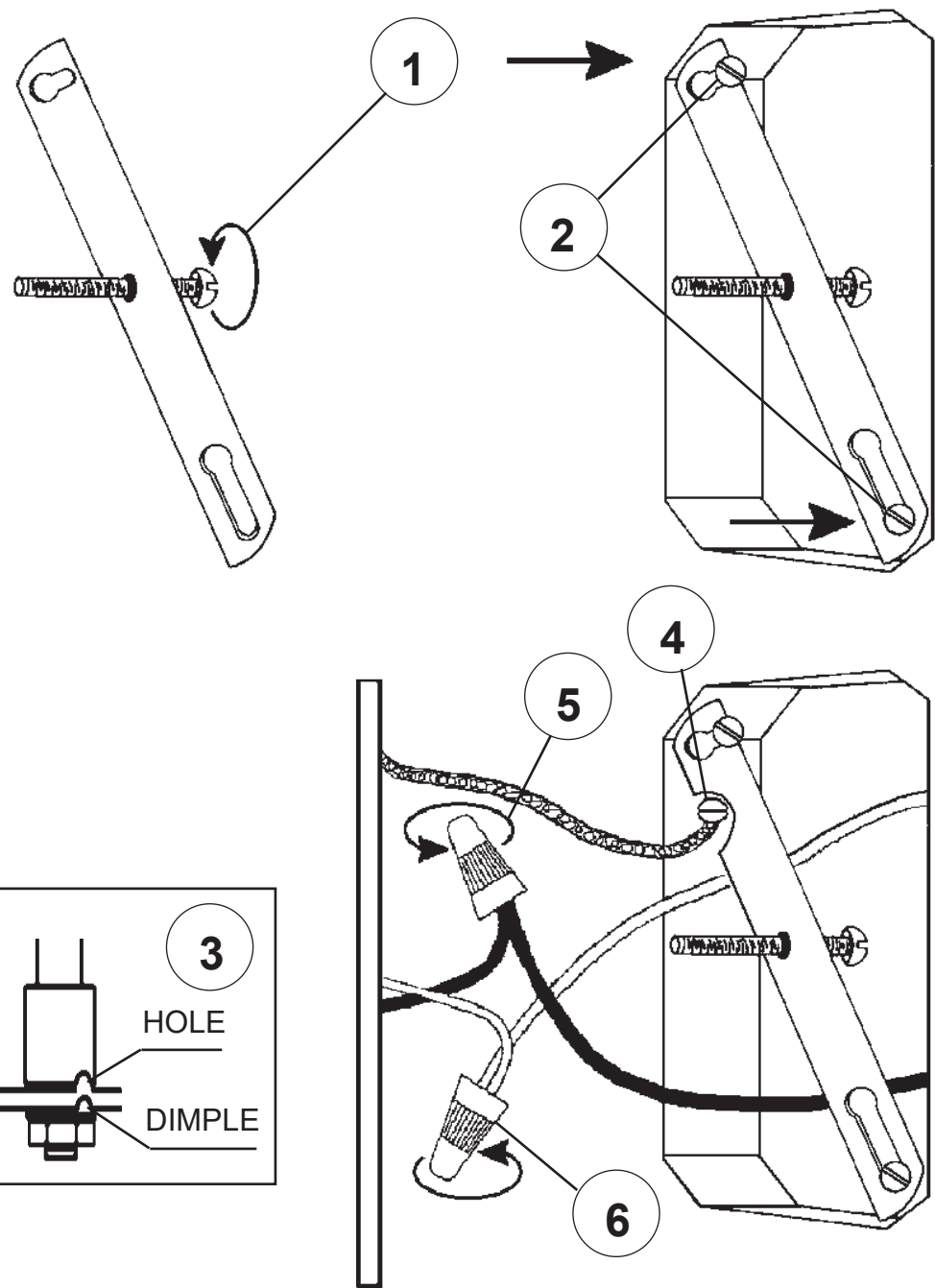

Turn arms to line up holes in arms with dimple in plate. Tighten lock washer and nut to secure arms in place.

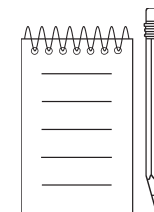
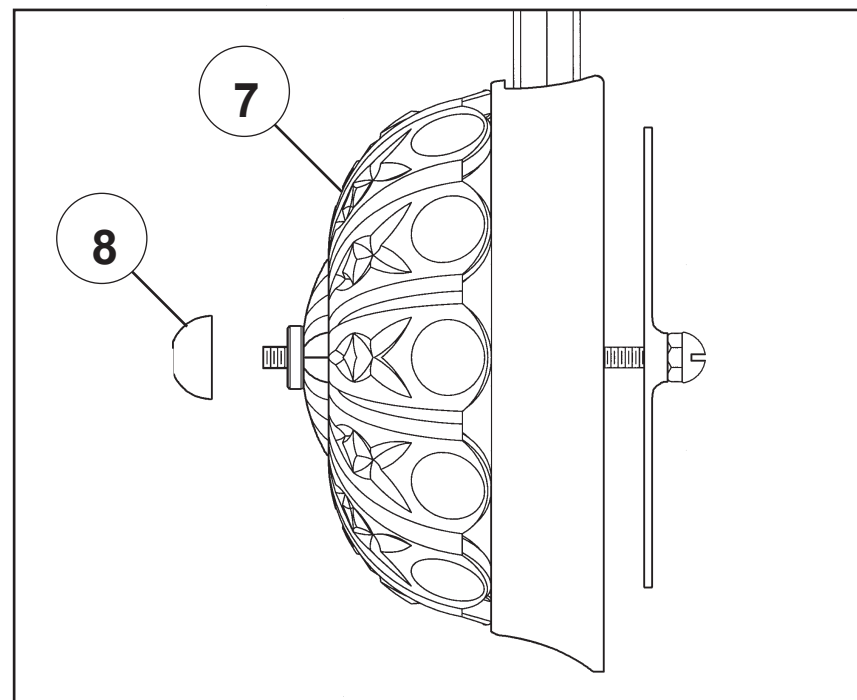
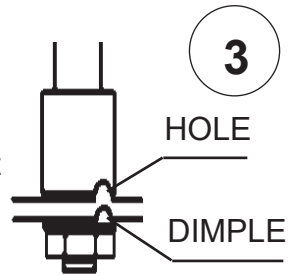

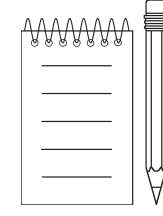
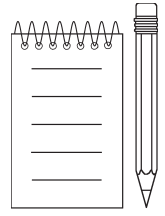



9

You will need 3 - B10  
25 Watts Recommended  
60 Watts Max

Install bulbs and be sure  
to test fixture **BEFORE**  
trimming.

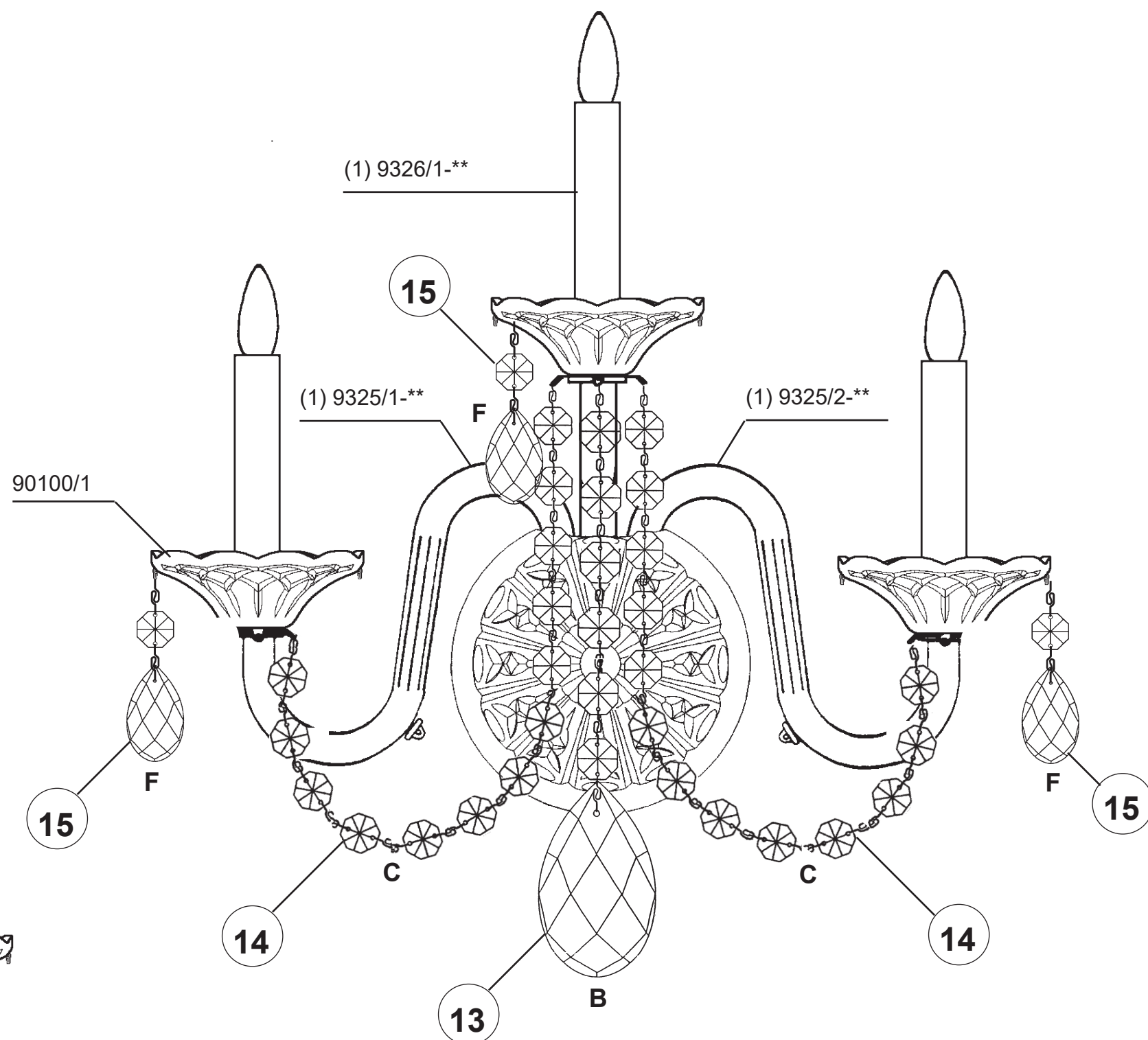
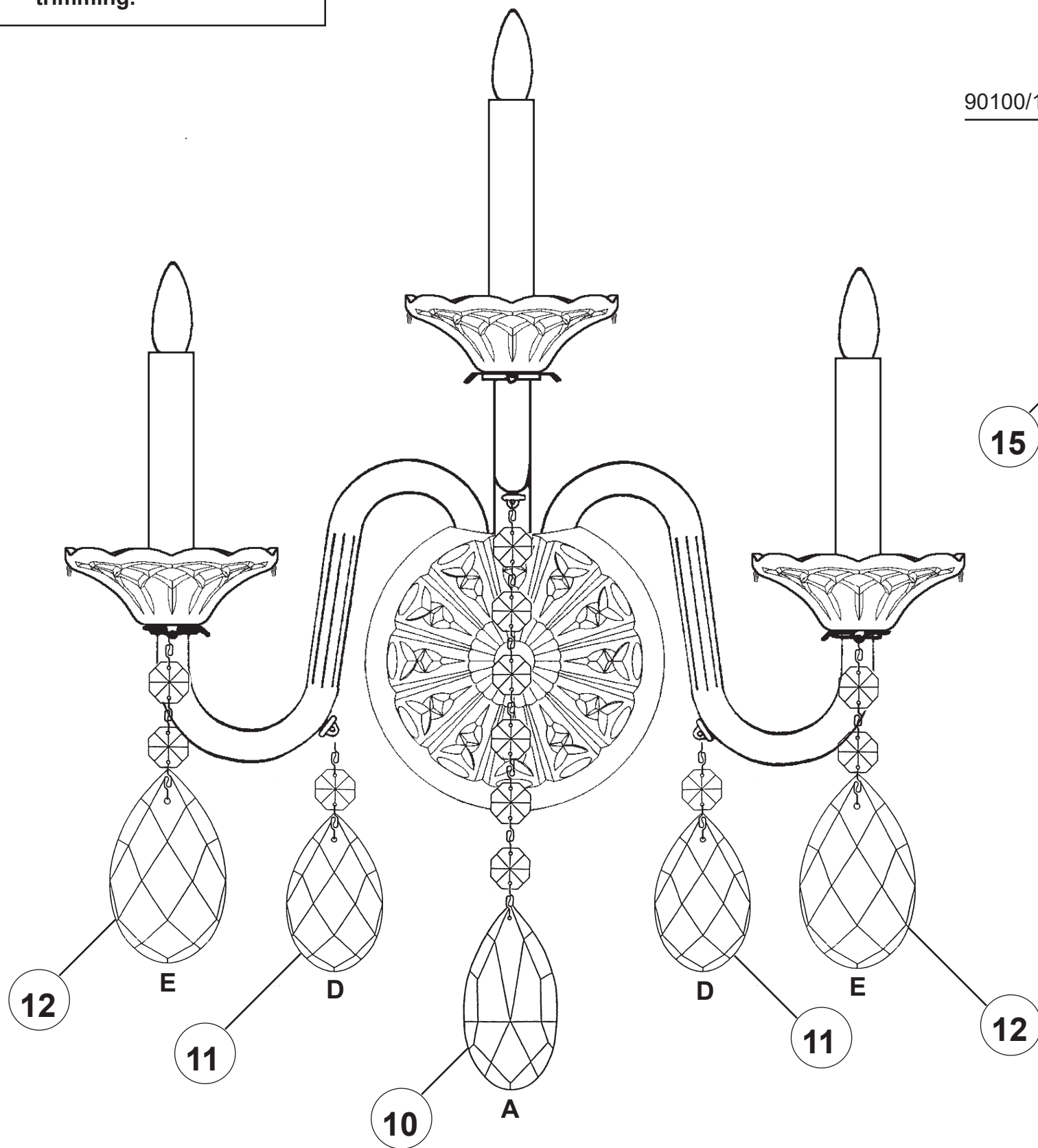

**CAUTION:**  
Glass parts are fragile. To Avoid  
breakage use care when  
assembling or cleaning.

