

BAGATELLE 1246- _ _ _













6 + 1 Lights
Diameter: 21"
Body Length: 22-1/2"
Hanging Weight: 13 lbs.

THIS DESIGN IS THE PROPRIETARY
TRADE DRESS/TRADEMARK OF
W SCHONBEK LLC.

 **SCHONBEK** | 1870

 **SCHONBEK** | 1870

								
MAX 60 W		110-120 V						

All electrical components must be installed by a licensed electrician in accordance with the National Electric Code and the appropriate local electrical codes.

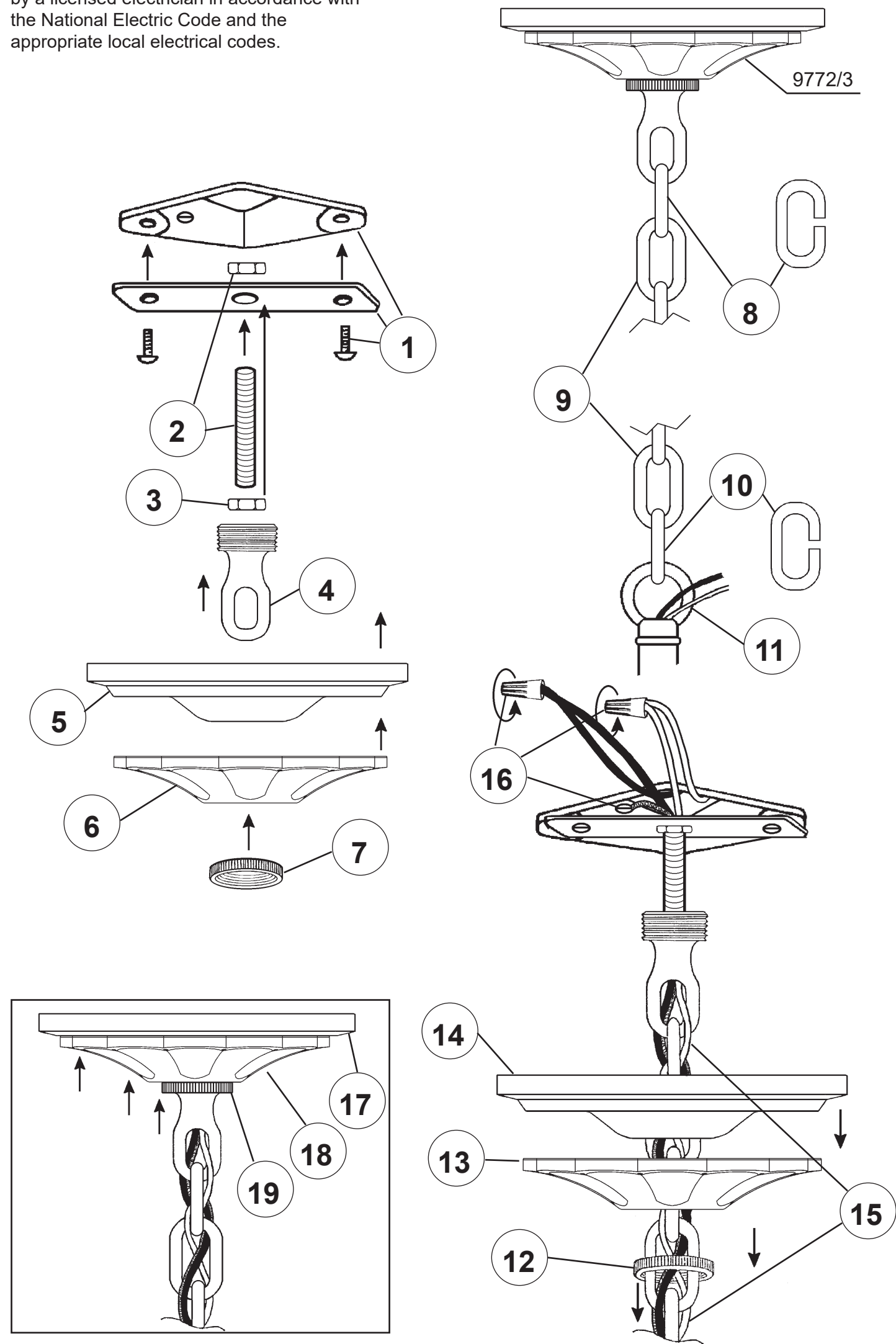





20

You will need 6 - B10
25 Watts Recommended
60 Watts Max

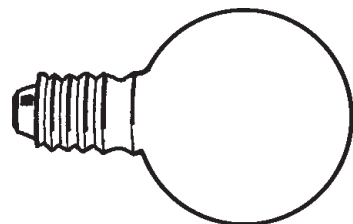

You will need 1 - G16-1/2
25 Watts Recommended
60 Watts Max

Install bulbs and be sure
to test fixture **BEFORE**
trimming.

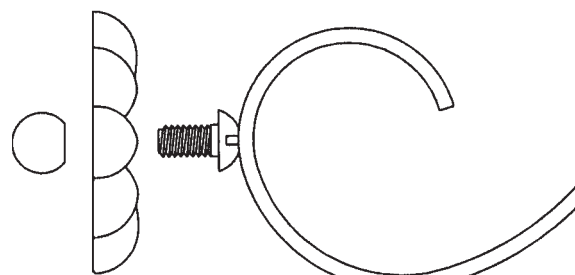

21

Slide rosettes with flat side
facing towards you onto
the screws and secure with
balls provided.

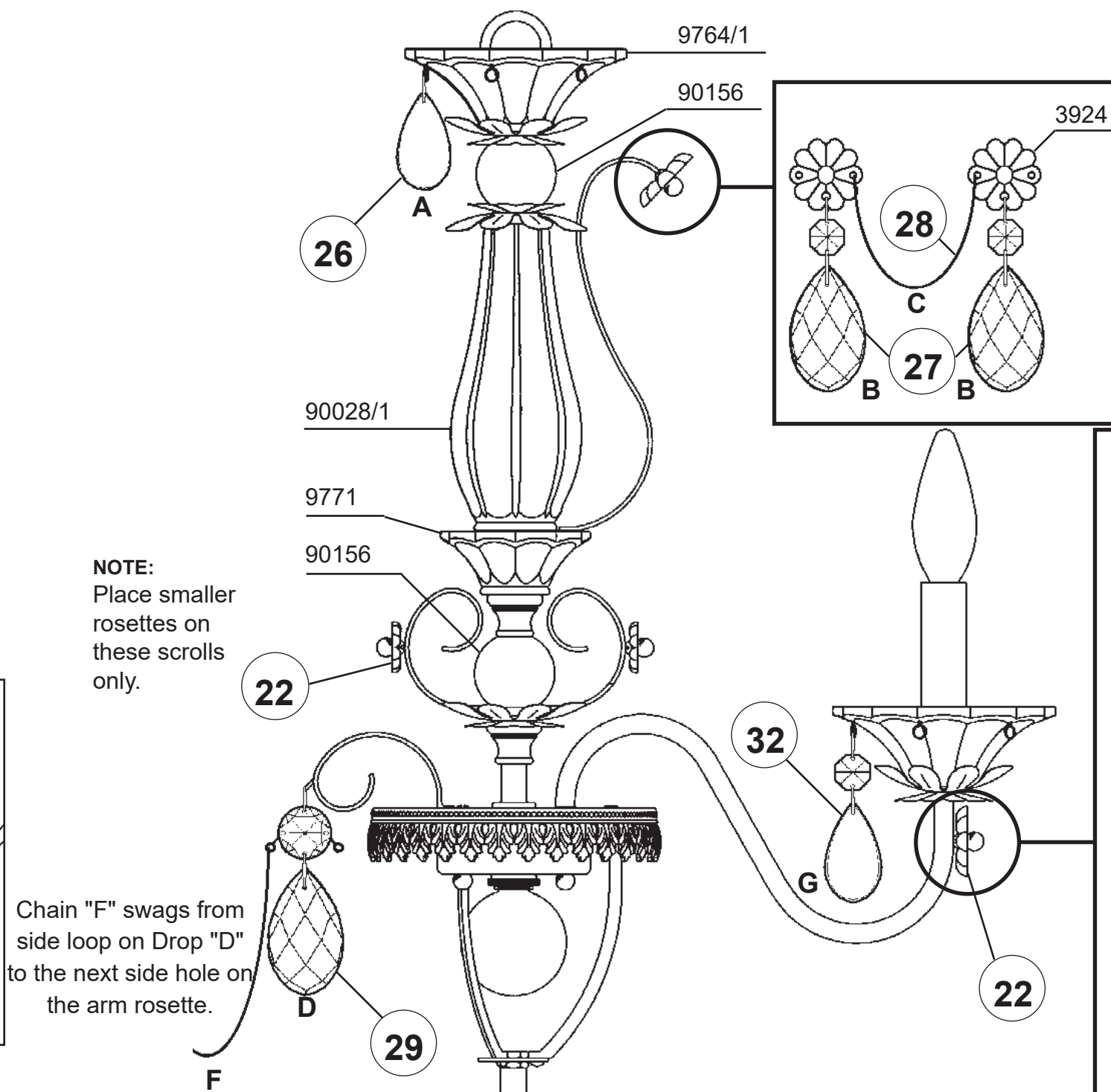

NOTE:
Place smaller
rosettes on
these scrolls
only.

Chain "F" swags from
side loop on Drop "D"
to the next side hole on
the arm rosette.

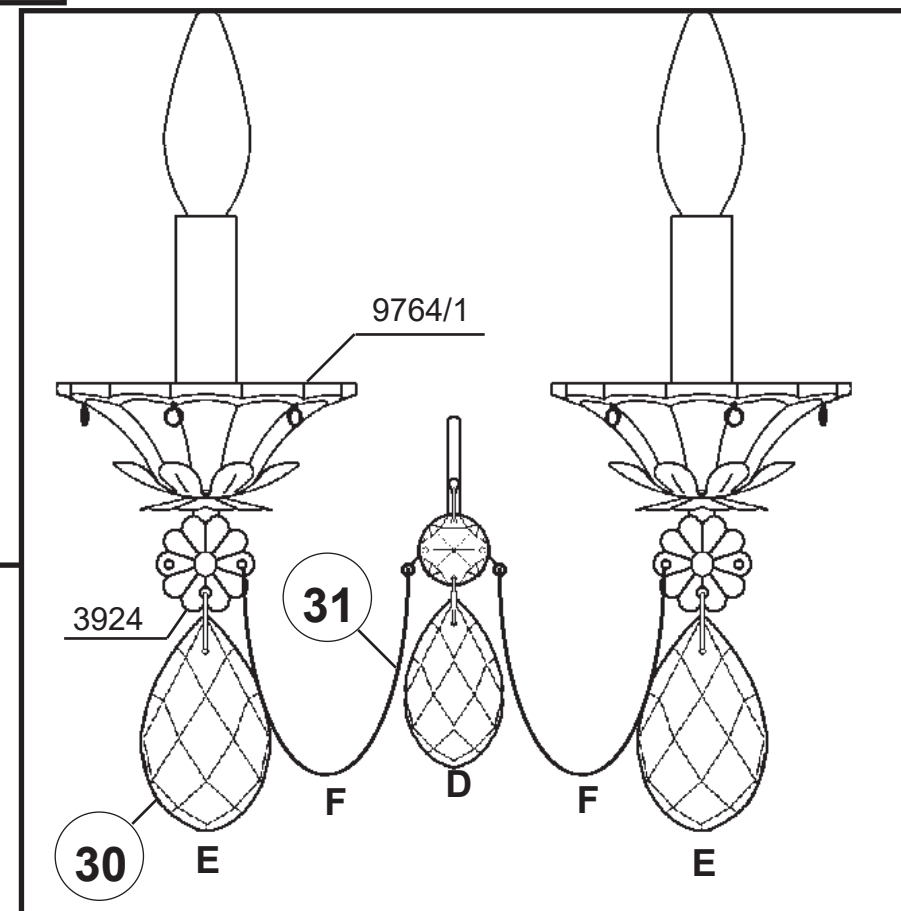

BAGATELLE 1246-__ __R













THIS DESIGN IS THE PROPRIETARY TRADE DRESS/TRADEMARK OF W SCHONBEK LLC.

6 + 1 Lights
Diameter: 21"
Body Length: 22-1/2"
Hanging Weight: 13 lbs.

 **SCHONBEK** | 1870

 **SCHONBEK** | 1870

								
MAX 60 W		110-120 V						

All electrical components must be installed by a licensed electrician in accordance with the National Electric Code and the appropriate local electrical codes.

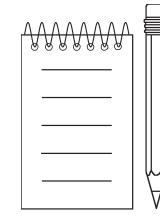
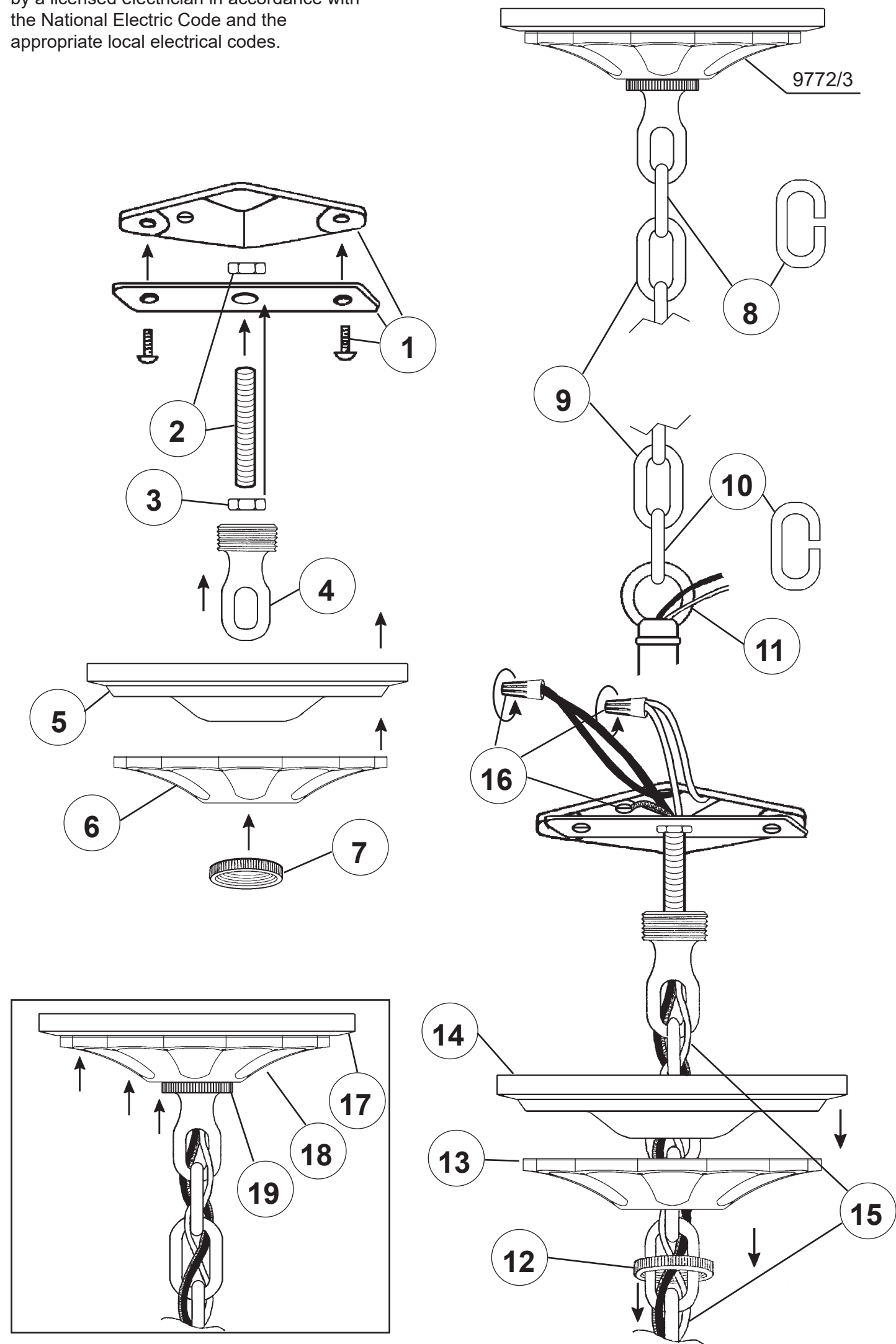

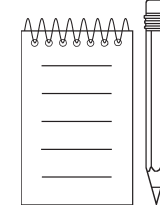
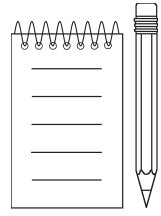



20

You will need 6 - B10
25 Watts Recommended
60 Watts Max

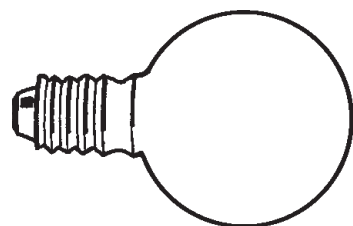

You will need 1 - G16-1/2
25 Watts Recommended
60 Watts Max

Install bulbs and be sure
to test fixture **BEFORE**
trimming.

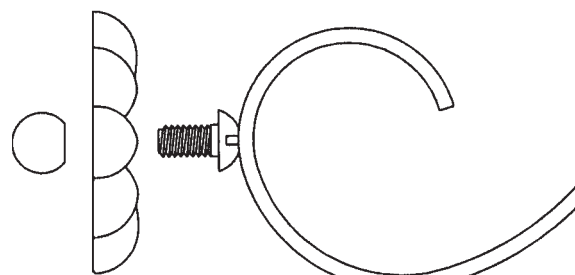

21

Slide rosettes with flat side
facing towards you onto
the screws and secure with
balls provided.

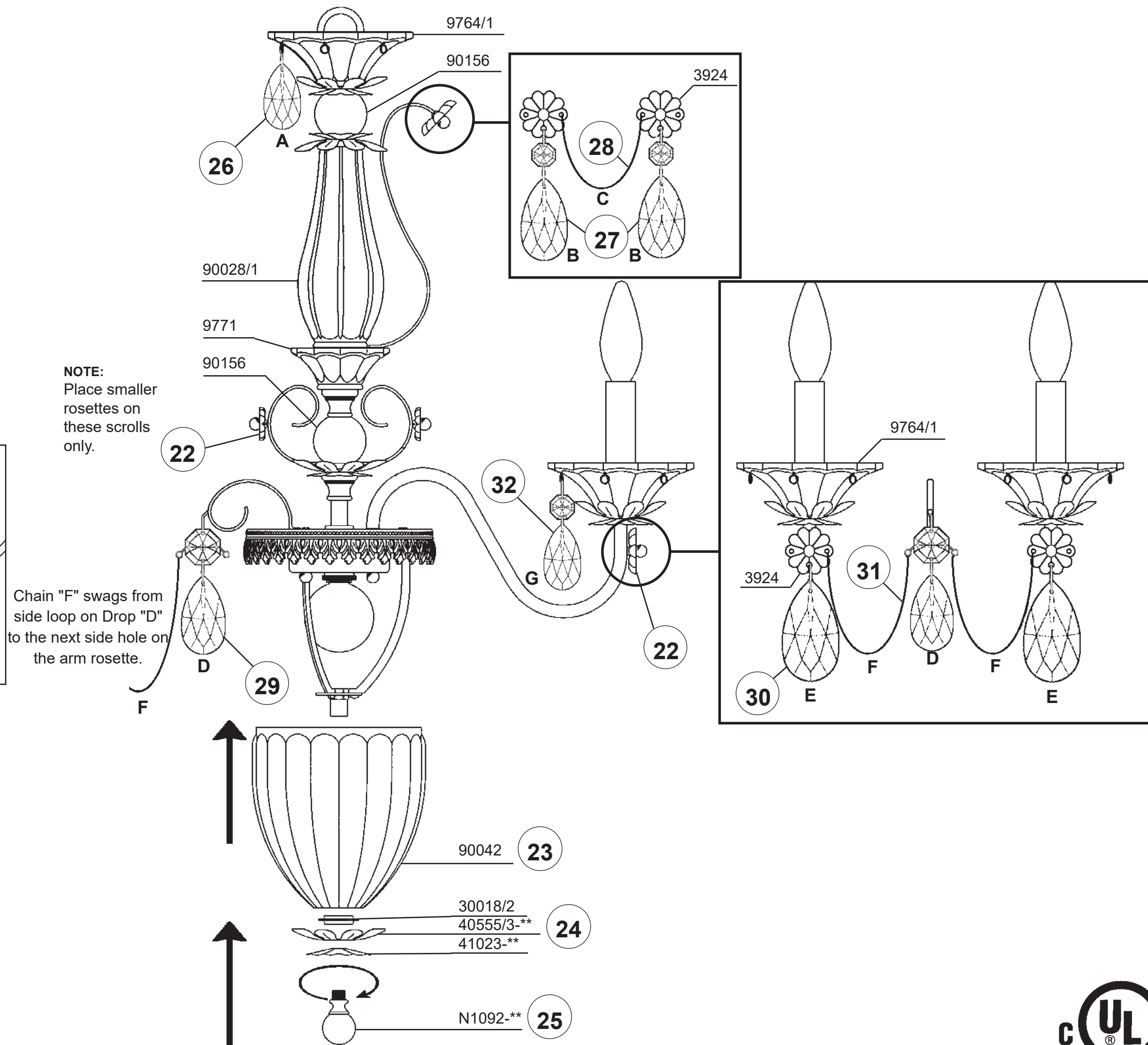

BAGATELLE 1246- _____













6 + 1 Lights
Diameter: 21"
Body Length: 22-1/2"
Hanging Weight: 13 lbs.

THIS DESIGN IS THE PROPRIETARY
TRADE DRESS/TRADEMARK OF
W SCHONBEK LLC.

 **SCHONBEK** | 1870

 **SCHONBEK** | 1870

								
MAX 60 W		110-120 V						

All electrical components must be installed by a licensed electrician in accordance with the National Electric Code and the appropriate local electrical codes.

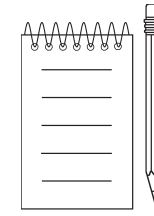
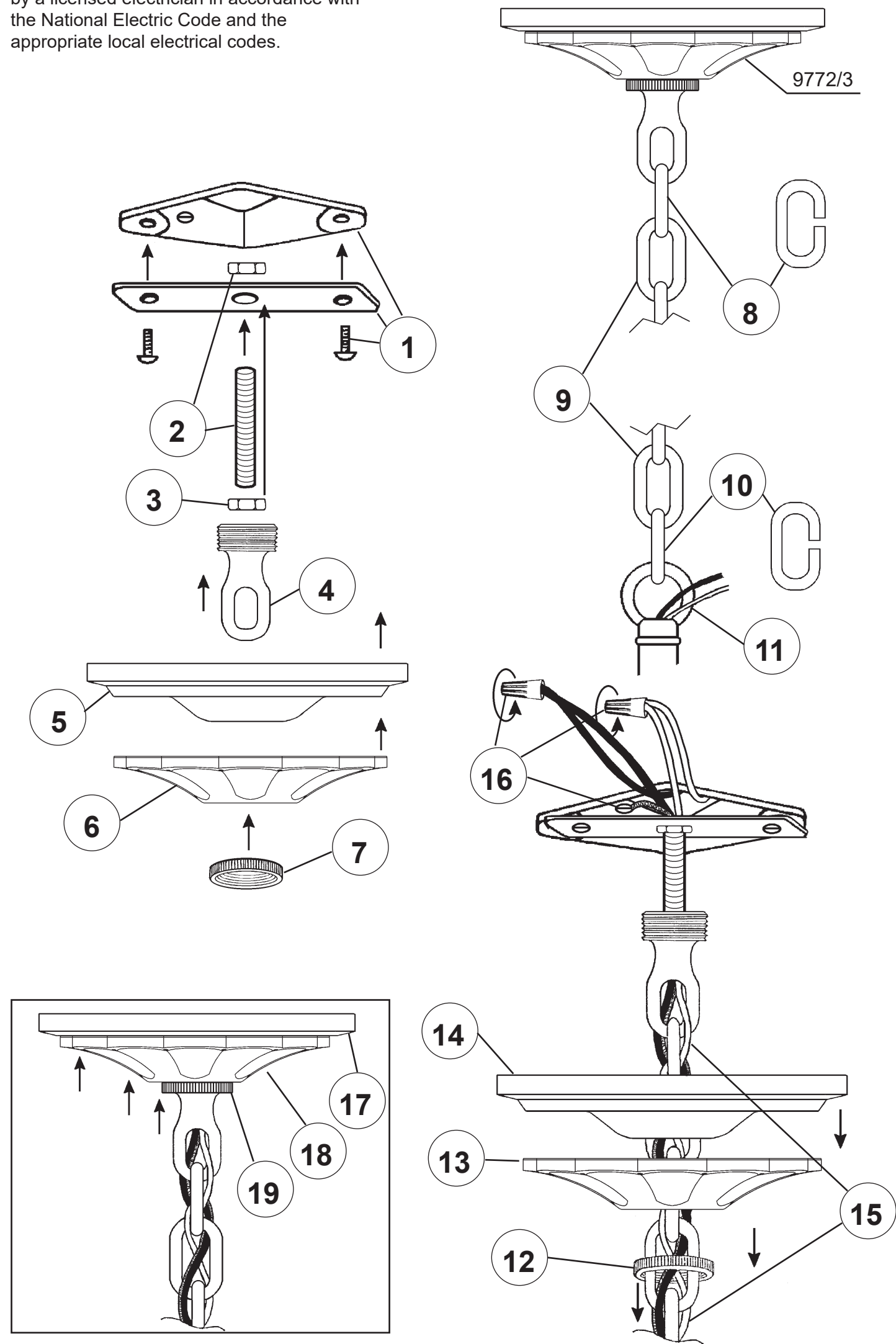





20

You will need 6 - B10
25 Watts Recommended
60 Watts Max

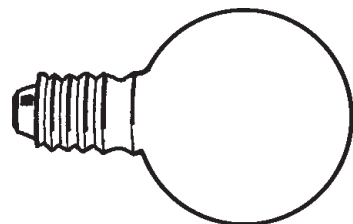

You will need 1 - G16-1/2
25 Watts Recommended
60 Watts Max

Install bulbs and be sure
to test fixture **BEFORE**
trimming.

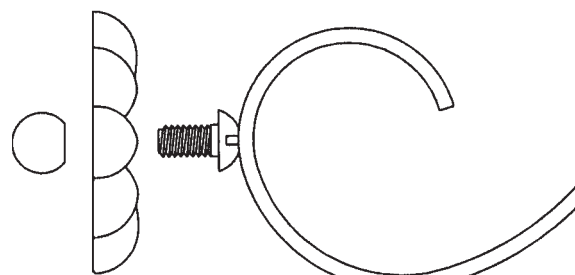

21

Slide rosettes with flat side
facing towards you onto
the screws and secure with
balls provided.

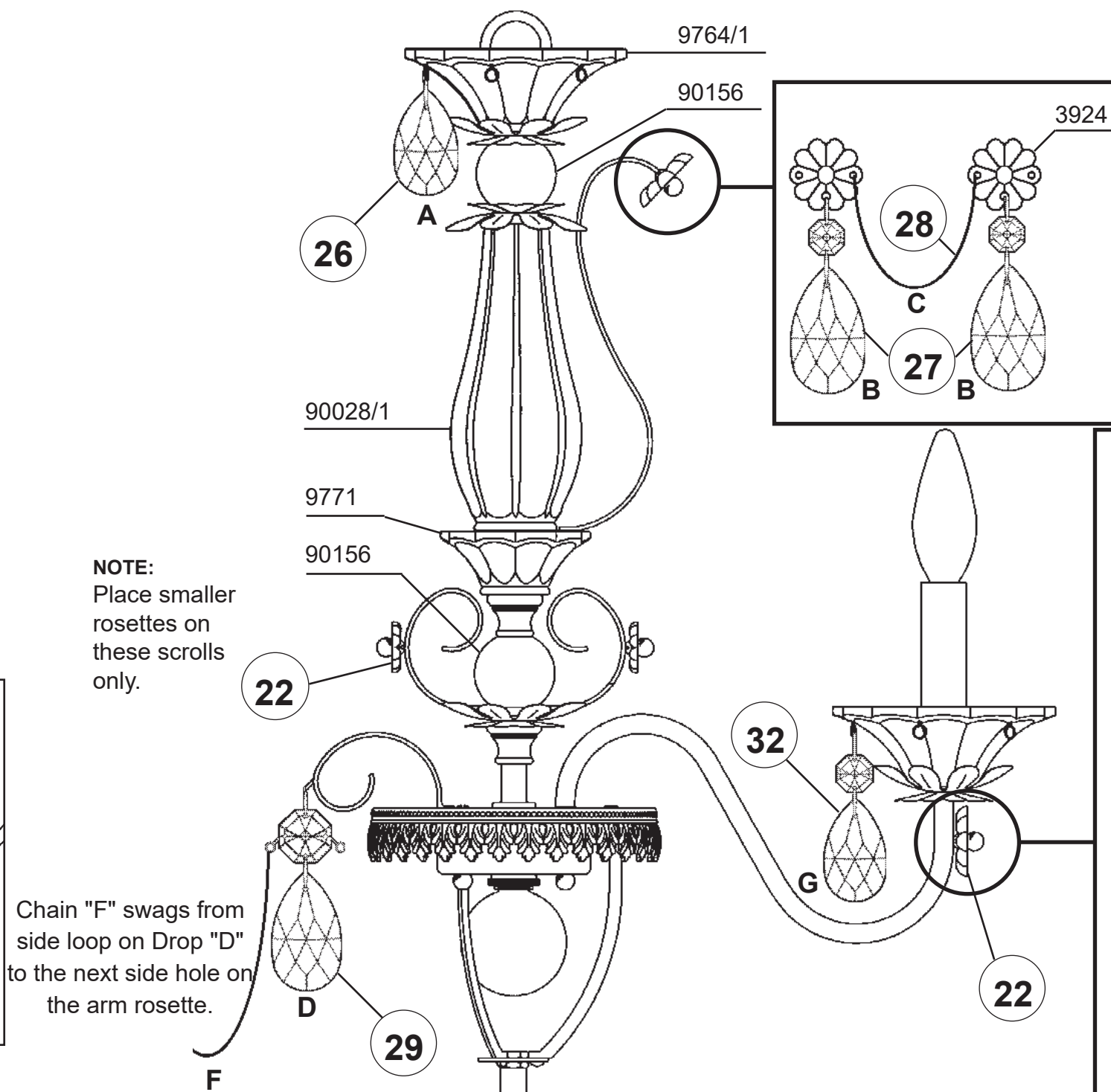

NOTE:
Place smaller
rosettes on
these scrolls
only.

Chain "F" swags from
side loop on Drop "D"
to the next side hole on
the arm rosette.

