

Tools Required

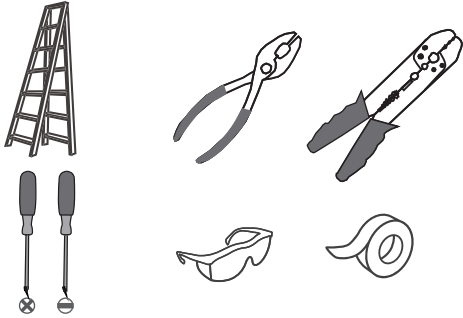

Light Source

15W
LED

Warnings and Cautions

Turn off the electricity at the circuit breaker before installation. Consult a licensed electrician if in doubt about installation.

Package Contents

Preparation: Identify and inspect all parts before beginning the installation.

Missing or damaged parts? Contact your original place of purchase.

PARTS BAG

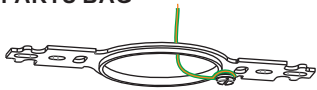

A Mounting Bracket
x 1



B Outlet Box Screw
x 2



C Wire Connector
x 3



D Fixture Body
x 1

Table of Contents

Mounting Bracket

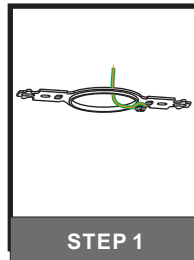

Wiring

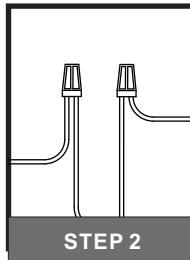

Fixture Body

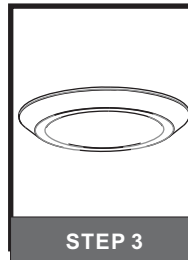

STEP 1

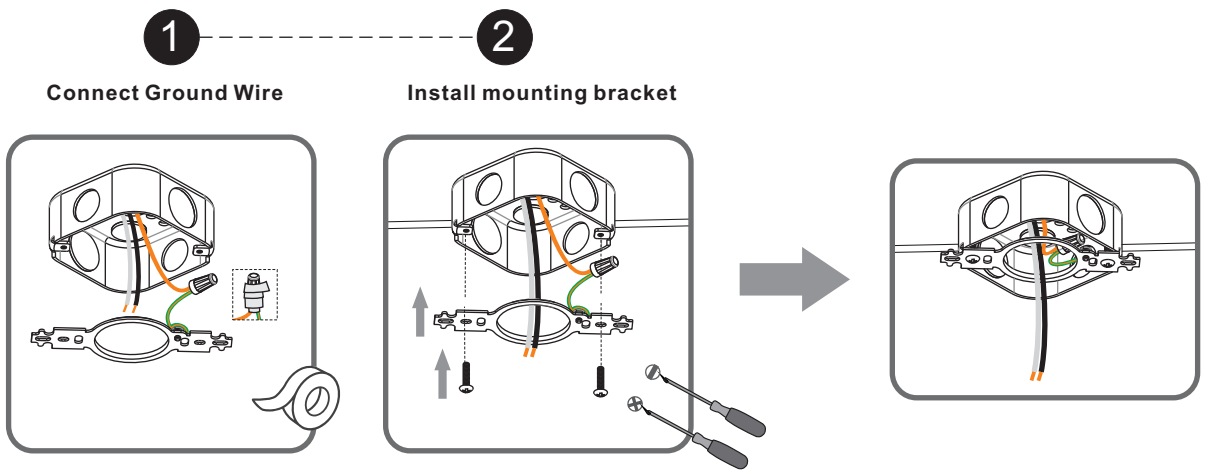

STEP 2

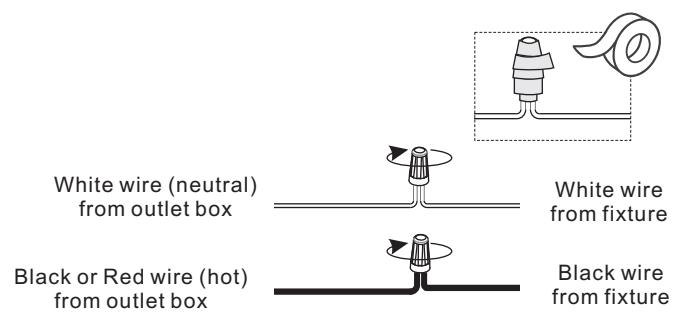

STEP 3

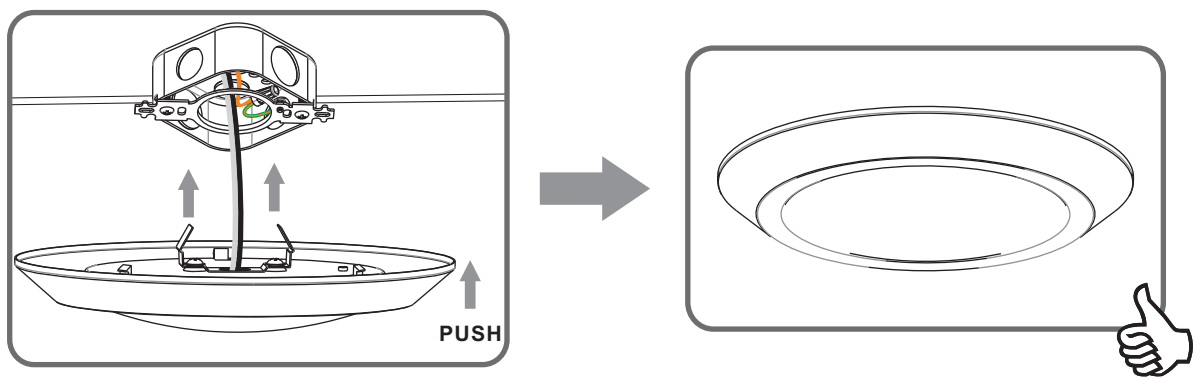

MAINTENANCE - HOW TO REMOVE THE FIXTURE BODY AFTER ASSEMBLY.

