

**Tools Required**

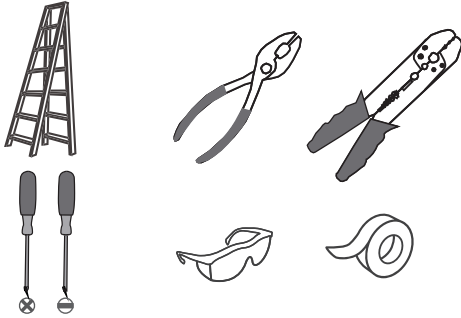

**Light Source**

15W  
**LED**

**Warnings and Cautions**

Turn off the electricity at the circuit breaker before installation. Consult a licensed electrician if in doubt about installation.

**Package Contents**

**Preparation:** Identify and inspect all parts before beginning the installation.

Missing or damaged parts? Contact your original place of purchase.

**PARTS BAG**

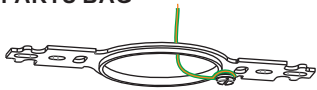

**A** Mounting Bracket  
x 1



**B** Outlet Box Screw  
x 2



**C** Wire Connector  
x 3



**D** Fixture Body  
x 1

**Table of Contents**

**Mounting Bracket**

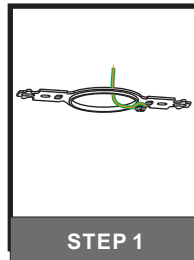

**Wiring**

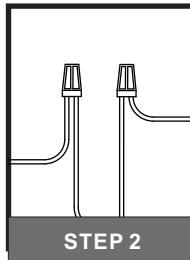

**Fixture Body**

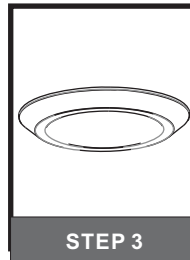

**STEP 1**

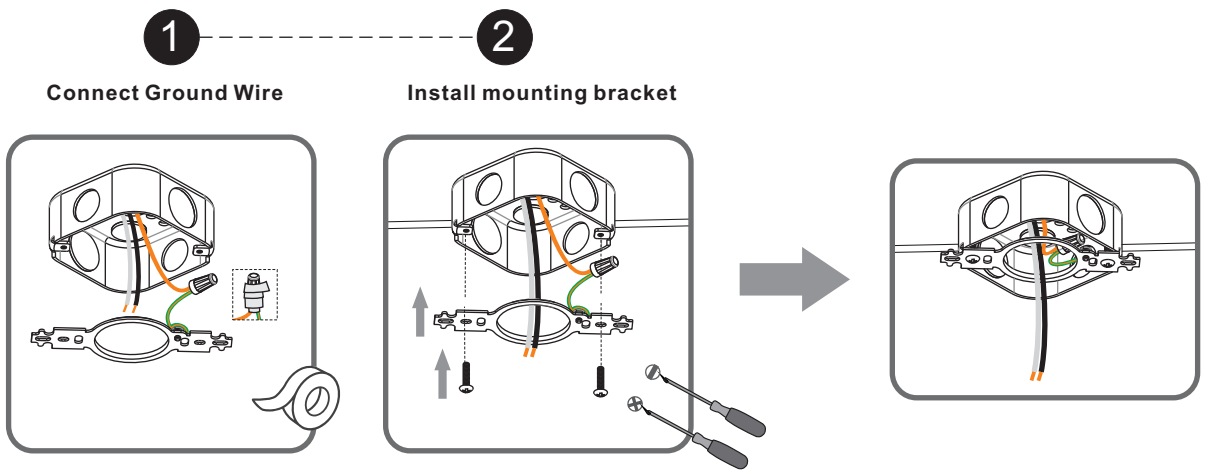

**STEP 2**

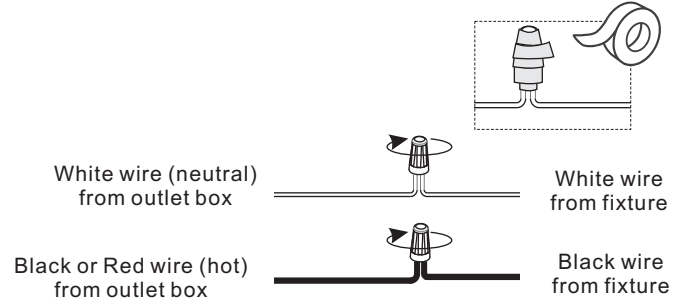

**STEP 3**

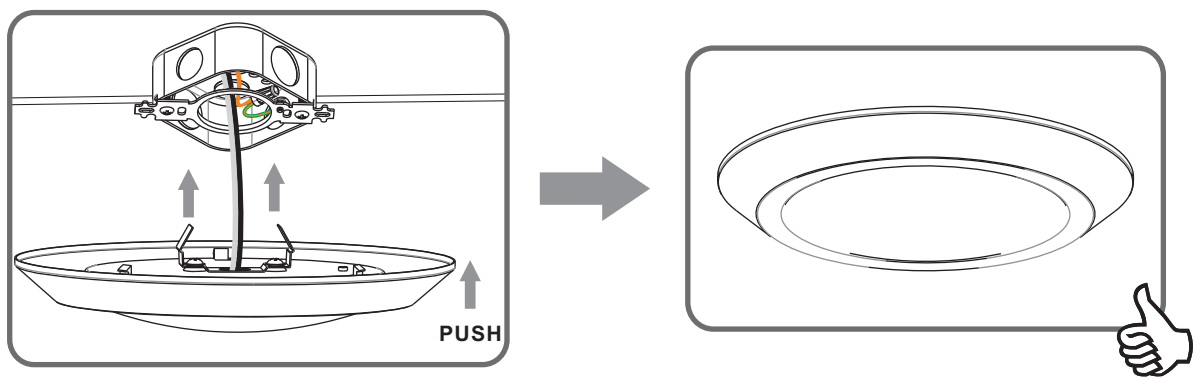

**MAINTENANCE - HOW TO REMOVE THE FIXTURE BODY AFTER ASSEMBLY.**

