

Please go to www.quoizel.com for product cleaning tips. Go to the **Care + Maintenance** selection.

Tools Required: Flathead screwdriver, Phillips screwdriver, pliers, wire cutters, wire strippers, electrical tape, safety glasses.

Light Source: (4) G9 Xenon Frosted bulb (Supplied), 40W Maximum.

Estimated Assembly Time: 20-30 minutes

Preparation: Identify and inspect all parts before beginning installation. Check package content list and diagrams below to be sure all parts are present. If any parts are missing or damaged, do not attempt to assemble, install, or operate the fixture. Missing Parts? Contact your original place of purchase.

⚠ Warnings and Cautions

Turn off electricity at circuit breaker or main fuse box before installation. Consult a licensed electrician if in doubt.

These instructions are provided for your safety. It is very important you read them completely before installing the fixture. We strongly recommend that a licensed, professional electrician perform the installation.

Disconnect fixture from power source before replacing bulbs. Make sure bulbs are given sufficient time to cool before removal.

Do not touch the bulb with bare hands use a cloth or glove.

Package Contents

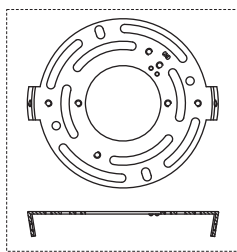

A Crossbar
x 1

B Mounting Screw
x 2

C G9 Frosted
Xenon Bulb
x 4

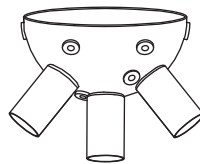

D Fixture Body
x 1

E Stem
x 9

I Outlet Box Screw
x 2

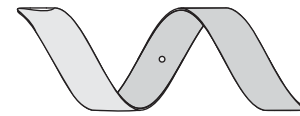

F Trimming
x 9

G Rubber Washer
x 18

H Lock Ball
x 9

J Wire Connector
x 3

STEP 1 - Install the Crossbar to the junction box

A. Attach the Crossbar (A) to the outlet box with the head of the green ground screw facing you. Secure it with Outlet Box Screws (I). Hand tighten until snug with screwdrivers.

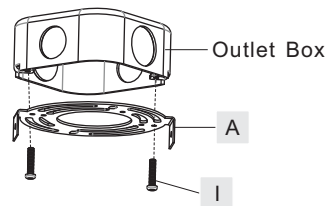

Figure 1

STEP 2 - Wire Connections

A. Wrap bare or green ground wire around green ground screw on the crossbar, no less than 2 inches from the end of the wire. Tighten the green ground screw.
B. Use standard wire connectors (J) to make all wire connections. Twist connectors until wires are tightly joined together. Wrap each connection with approved electrical tape and carefully stuff all the connected wires into the outlet box.

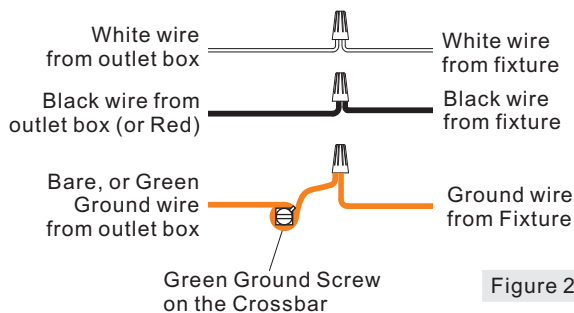

Figure 2

STEP 3 - Install Fixture to Ceiling

A. Place ceiling canopy on the Fixture Body (D) over the Crossbar (A). Line up Holes on the side of ceiling canopy and the Mounting Hole on the Crossbar (A). Secure by threading Mounting Screws (B) into the Crossbar (A). Tighten until snug.

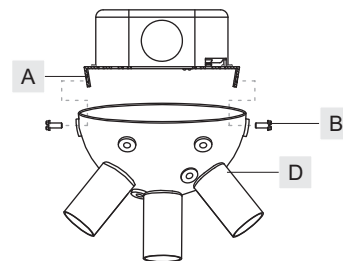

Figure 3

STEP 4 - Install Bulbs

A. Insert bulbs (C) into sockets and push snugly into place.

IMPORTANT: Do not touch the bulb with bare hands use a cloth or glove.

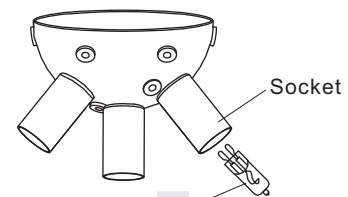

Figure 4

STEP 5 – Install Trimming to Fixture

- A. Thread the Short Nipple end of Stem (E) into the Fixture Body (D). Hand tighten until snug.
- B. Peel off Protective Films on Trimmings (F).
Note: Gloves are required to avoid leaving fingerprints or scratches on Trimmings (F).
- C. Place the Trimming (F) and Rubber Washers (G) over the other end of Stem (E) as shown. Secure by threading Lock Ball (H) onto the Stem (E). Hand tighten until snug.

Your fixture is now assembled and ready to use. Enjoy!

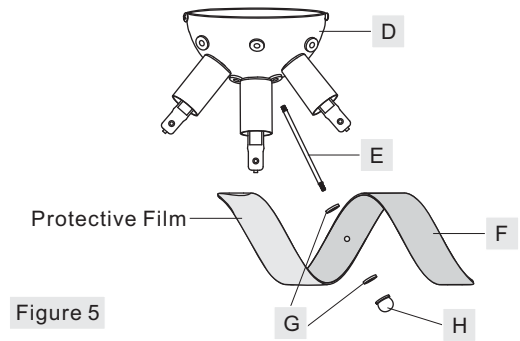

Figure 5

CAUTION FOR BULB REPLACING

- A. When replace bulb, turn off power and allow lamp to cool. For safety purpose, wear gloves and eye protection.
- B. If bulb is scratched or cracked, DO NOT use the lamp to avoid breakage during use or installation.
- C. Use only in fixtures rated for lamps wattage and voltage.
- D. Prevent the bulb from contacting liquid or combustible materials.