

Please go to www.quoise.com for product cleaning tips. Go to the **Care + Maintenance** selection.

Tools Required: Flathead screwdriver, Phillips screwdriver, pliers, wire cutters, wire strippers, electrical tape, safety glasses.

Light Source: (1) A19 Medium Base bulb 100W Maximum, Medium Base T9 Vintage Bulb is recommended, bulb not included.

Estimated Assembly Time: 30-45 minutes

Preparation: Identify and inspect all parts before beginning installation. Check package content list and diagrams below to ensure all parts are present. If any parts are missing or damaged, do not attempt to assemble, install, or operate the fixture. Contact your original place of purchase.

⚠ Warnings and Cautions

Turn off electricity at circuit breaker or main fuse box before installation. Consult a licensed electrician if in doubt.

These instructions are provided for your safety. It is very important you read them completely before installing the fixture. We strongly recommend that a licensed, professional electrician perform the installation.

Disconnect fixture from power source before replacing bulbs. Make sure bulbs are given sufficient time to cool before removal.

Package Contents

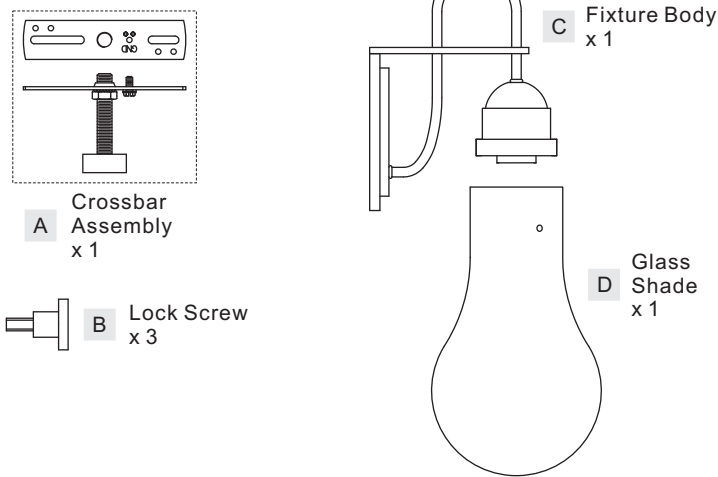

STEP 2 - Wire Connections

- Wrap bare or green ground wire around green ground screw on the crossbar, no less than 2 inches from the end of the wire. Tighten the green ground screw.
- Use standard wire connectors (not included) to make all wire connections. Twist connectors until wires are tightly joined together. Wrap each connection with approved electrical tape and carefully stuff all the connected wires into the Outlet Box.

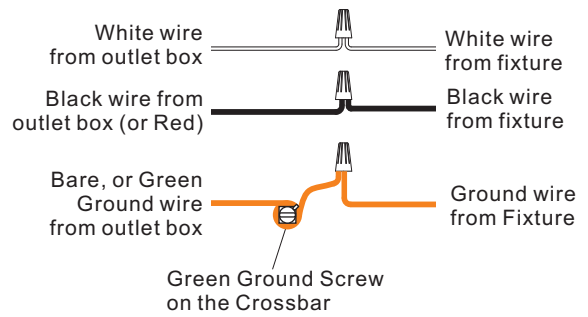

Figure 2

STEP 1 - Install the Crossbar Assembly to Outlet Box and Adjust the length of the Nipple

- Attach the Crossbar Assembly (A) to the outlet box with the head of the green ground screw facing you. Secure it with outlet box screws (not included), tighten until snug.
- Remove mounting ball from the Crossbar Assembly (A). Place the Fixture Body (C) over the end of the nipple against the wall to determine the correct position of the nipple. Thread the mounting ball onto the nipple. Adjust the nipple to allow the Fixture Body (C) to rest against the wall when held in place by the mounting ball.
- Remove the mounting ball and the Fixture Body (C). Tighten the lock washer and the hex nut against the crossbar to secure in place.

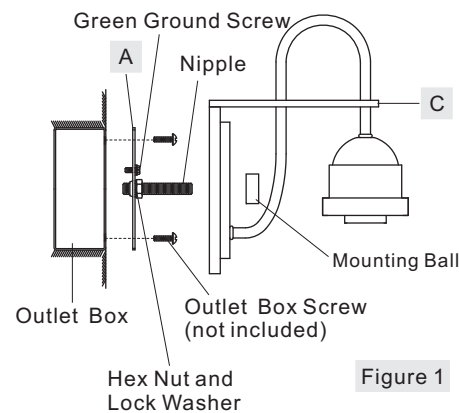

Figure 1

STEP 3 - Install Fixture Body

- Place the Fixture Body (C) over the end of the nipple and secure with previously removed mounting ball. Hand tighten until snug.

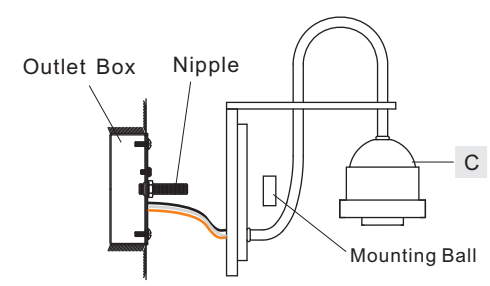

Figure 3

STEP 4 - Install Bulbs and Glass Shade

- A. Insert the bulb onto the socket and screw snugly into place.
- B. Place the Glass Shade (D) over the bulb and align the holes on the Glass Shade (D) to mounting holes on the socket cup. Place Lock Screws (B) through the holes on the Glass Shade (D) and thread them into mounting holes on the socket cup. Carefully release your hand after all Lock Screws (B) are tighten until snug.

Your fixture is now assembled and ready to use. Enjoy!

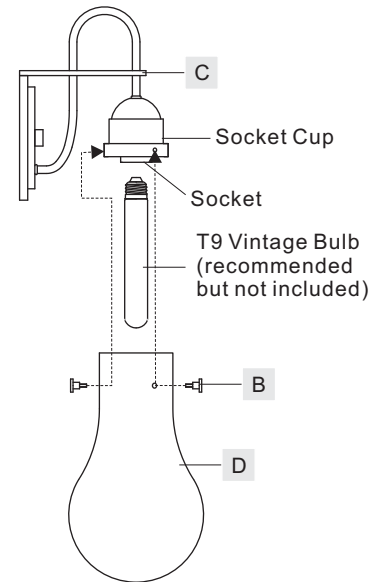
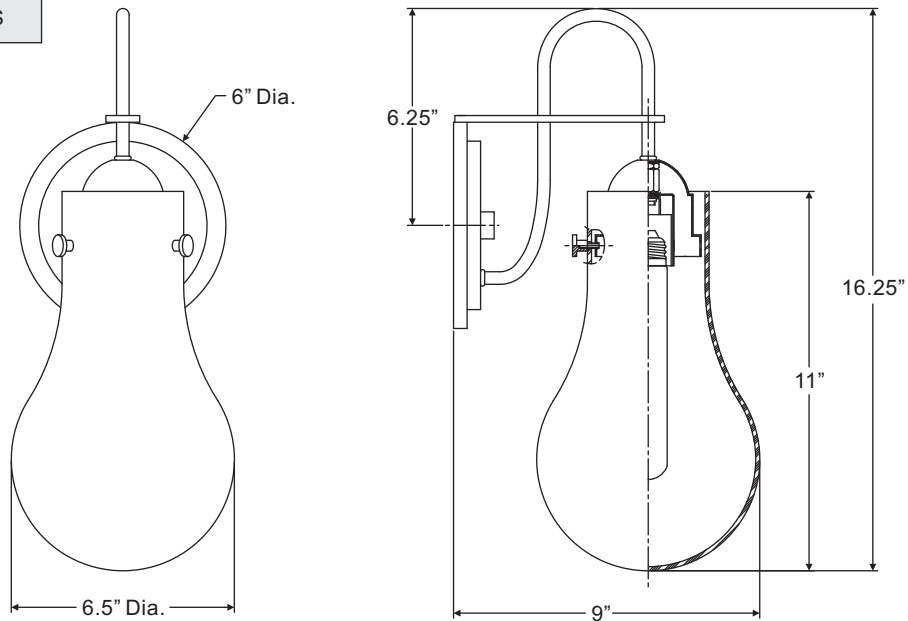
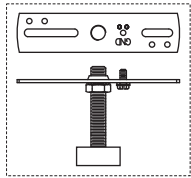

Figure 4

QW4065WS

FINISH: WEATHERED BRASS



NOTE: ALL DIMENSIONS ARE ROUNDED UP TO THE NEAREST 1/4"