

SAFETY INFORMATION

Released Date: 2021-10-15

Please read and understand this entire manual before attempting to assemble, install or operate the product.

CAUTION

- For your safety, read instructions completely before beginning installation.
- Quozel recommends 2 people for each step during assembly.

TOOLS REQUIRED

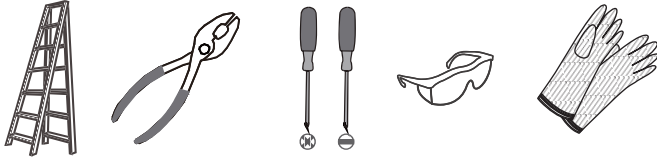

CARE AND MAINTENANCE

- Wipe clean using soft, dry cloth or static duster. Always avoid using harsh chemicals and abrasives to clean fixture as they may damage the finish.

If you need further assistance call Quozel Customer Care at 1-800-645-3184 (9:00am - 5:00pm EST), or visit us on-line at www.quozel.com.

PACKAGE CONTENTS

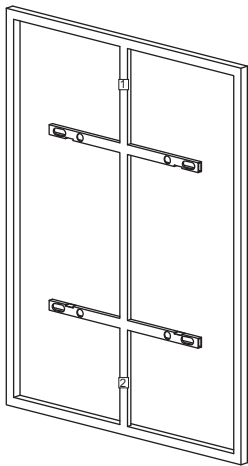

A Mirror Frame
x 1

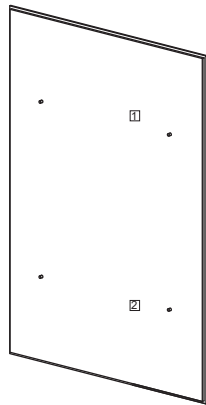

B Mirror
x 1



C Lock Ball
(preassembled
on mirror)
x 4

MOUNTING HARDWARE



AA Mirror Hanger
x 2



BB Hanger Nail
x 4

INSTALLATION

1 Install Mirror

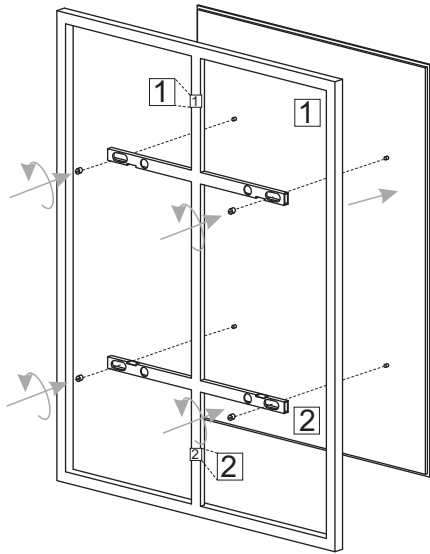

2 Identify the Points for mounting the Mirror Hangers By Using Measurement

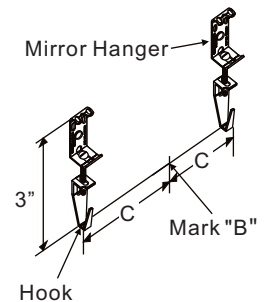
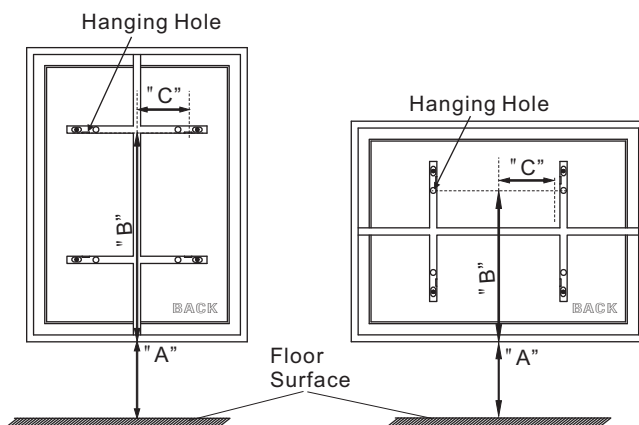

- Determine where the mirror will be placed on the wall and hold the mirror on the wall in the position you wish. Mark the wall at the bottom center of the mirror with a pencil lightly. This will be Measurement A, the distance from the floor to the bottom of the mirror.
- Place the mirror on a flat surface again and measure from the bottom of the mirror to the top quarter of Hanging Holes that will be used to hang the mirror, this is measurement B.
- Add measurement A from step A above and measurement B together and mark this spot on the wall where the mirror will be hung. Measurement B is straight up from Measurement A you marked on the wall in step A above.
- Measure the distance between the centerline of each hanging hole and then divide this measurement by 2, this is Measurement C. In order to locate the exact hanger location on the wall, from Measurement B go to the right the distance of Measurement C and mark the wall. Do this going to the left of Measurement B as well and mark the wall. These two marks are the center of the hangers, Measurement C. The two marks you just made on the wall are the same distance apart as the two hangers.
- To determine where the Mirror Hangers (A) will be fastened to the wall, measure up from Measurement C 3". Do this in two locations as illustrated and mark the wall.
- Refer to Step 3 to install Mirror Hangers on the wall.

INSTALLATION

3 Installing the 2 Mirror Hangers

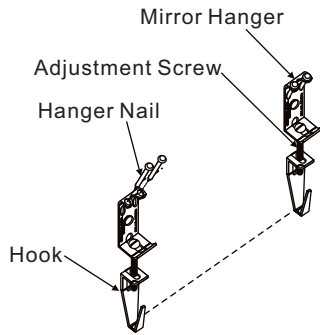

- A. Using the Nails provided with the Mirror Hangers attach the 2 Mirror Hangers to the wall at the position just marked by Option A or Option B. **Please note the Mirror Hangers are adjustable allowing for easy leveling of the mirror as needed.**
- B. Once you have both Mirror Hangers securely nailed in place, adjust as the length of the Mirror Hangers so that each Mirror Hanger is the same length.

4 Hanging the Mirror

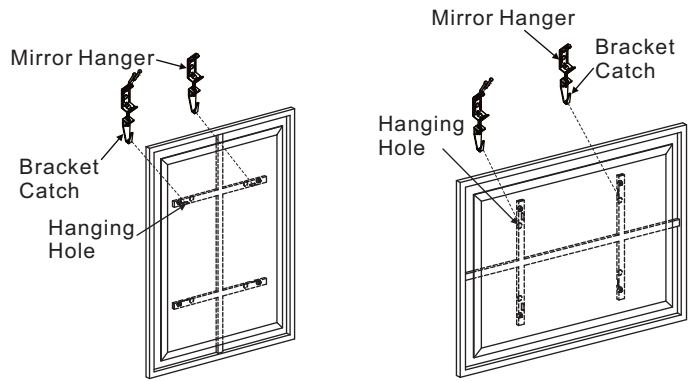

VERTICAL

HORIZONTAL

- A. With the help of another person place the mirror onto the mirror hanger hooks. Making sure each hook is securely hooked into the hangers before letting go of the mirror.
- B. If needed you May remove the mirror and adjust the mirror hanger hooks to level the mirror and replace the mirror.

Clean glass with household glass cleaner. Retain this sheet for future reference.