

**Tools Required**

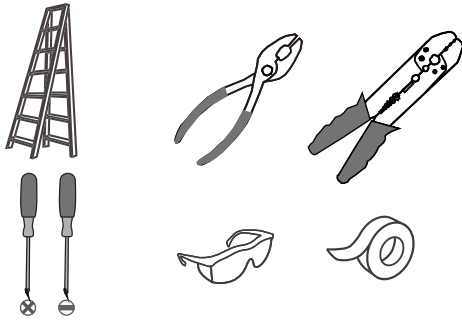

**Light Source**

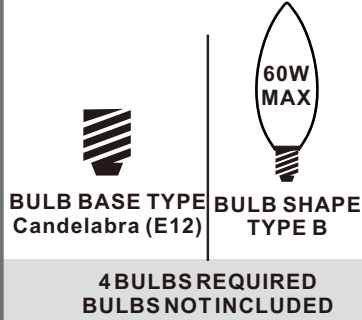

**Fixture Height Adjustable 25.5" to 61.5"**

**Warnings and Cautions**

Turn off the electricity at the circuit breaker before installation. Consult a licensed electrician if in doubt about installation.

Turn off power to the fixture and allow the bulbs to cool before replacing.

**Package Contents**

**Preparation:** Identify and inspect all parts before beginning the installation.

Missing or damaged parts? Contact your original place of purchase.

**PARTS BAG**

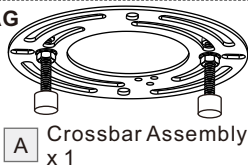

**A** Crossbar Assembly x 1



**B** Outlet Box Screw x 2



**C** Wire Connector x 3

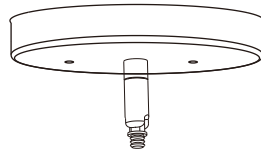

**D** Ceiling Canopy x 1



**E** 6" L Rod x 2



**F** 12" L Rod x 2

**G** Fixture Body x 1

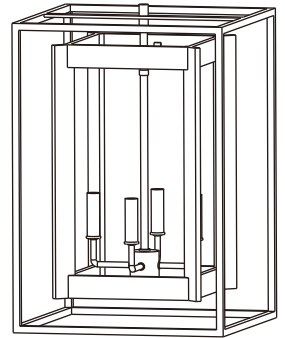

**Table of Contents**

**Crossbar Assembly**

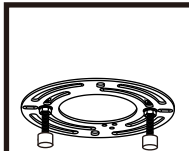

STEP 1

**Downrod**



STEP 2

**Lanyard**

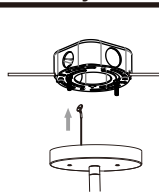

STEP 3

**Wiring**

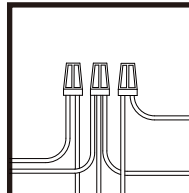

STEP 4

**Ceiling Canopy**

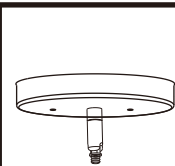

STEP 5

**Bulb**



STEP 6

**STEP 1**

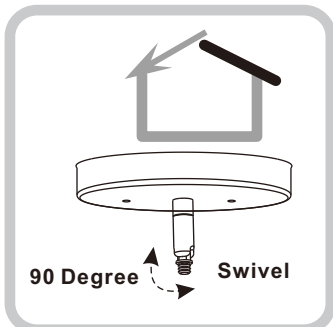

90 Degree Swivel

For angled ceilings, Swivel opening towards wall.

**1**

Step 1  
Install crossbar assembly

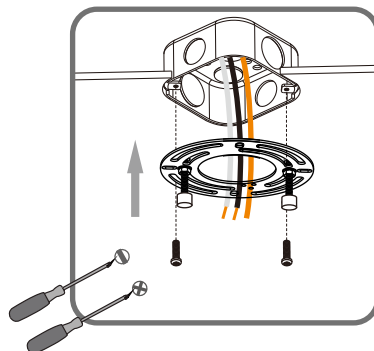

**2**

Step 2 - 3  
Test fitting ceiling canopy to mounting screws

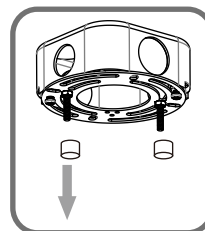

**3**

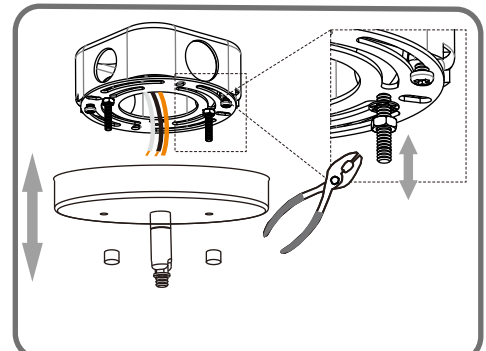

## STEP 2

### Optional Rods

8' ceiling:  
(2) 6"L rods  
9' ceiling:  
(2) 6"L + (1) 12"L rods  
10' ceiling:  
(2) 6"L + (2) 12"L rods

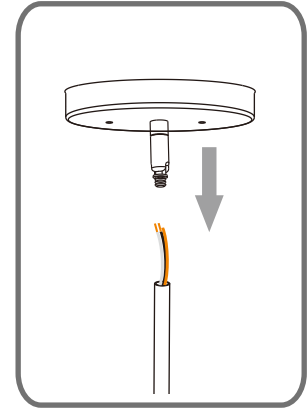
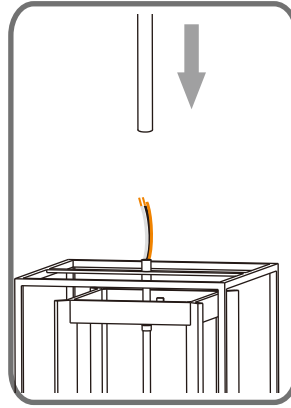
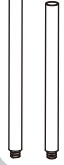

## STEP 3

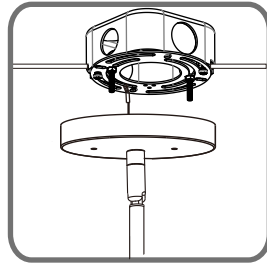
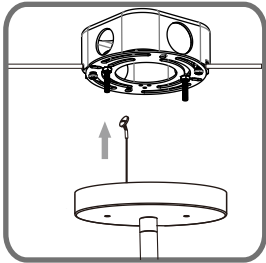

## STEP 4

White wire (neutral)  
from outlet box

Black or Red wire (hot)  
from outlet box

Bare or Green ground wire  
from outlet box

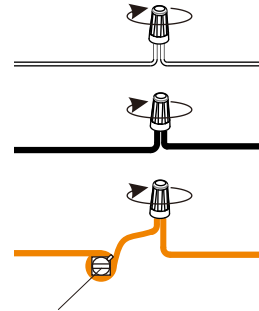

White wire  
from fixture

Black wire  
from fixture

Ground wire  
from Fixture

\*Green Ground Screw on crossbar optional

## STEP 5

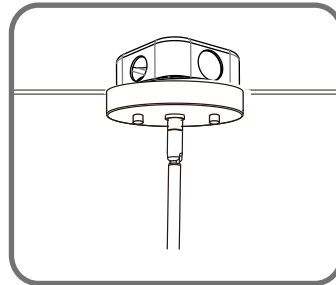
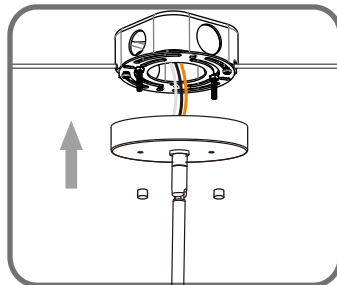

## STEP 6

