

Tools Required

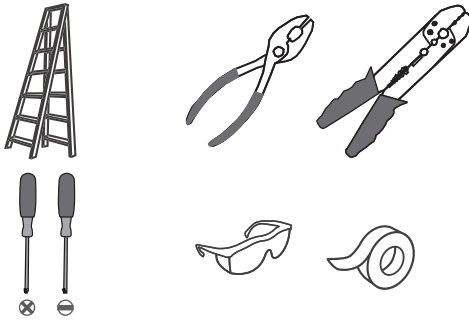

Light Source

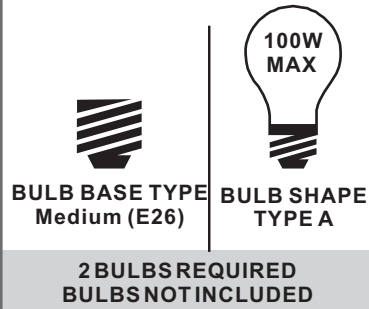

Warnings and Cautions

Turn off the electricity at the circuit breaker before installation. Consult a licensed electrician if in doubt about installation.

Turn off power to the fixture and allow the bulbs to cool before replacing.

Package Contents

Preparation: Identify and inspect all parts before beginning the installation.

Missing or damaged parts? Contact your original place of purchase.

PARTS BAG

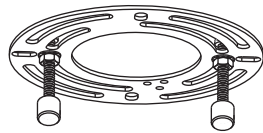

- A** Crossbar Assembly x 1
- B** Outlet Box Screw x 2
- C** Wire Connector x 3

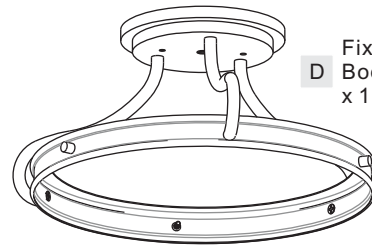

D Fixture Body x 1



F Stem Assembly x 1

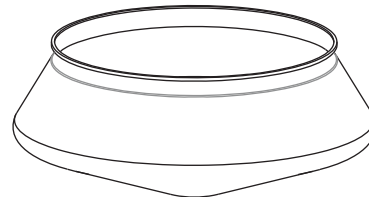

E Shade x 1

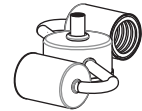

G Socket Assembly x 1

Table of Contents

Socket Assembly, Stem Assembly & Fixture Body

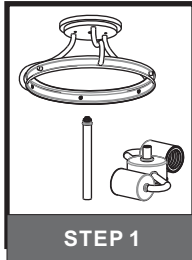

Crossbar Assembly

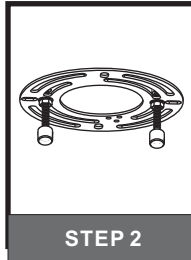

Wiring

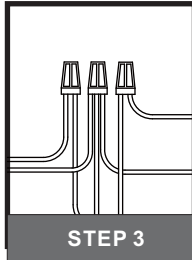

Fixture Body

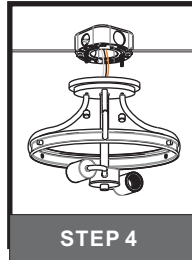

Shade

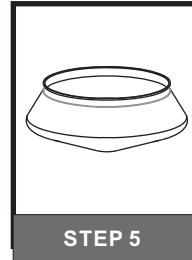

Bulbs

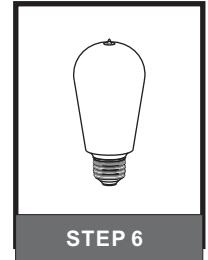

STEP 1

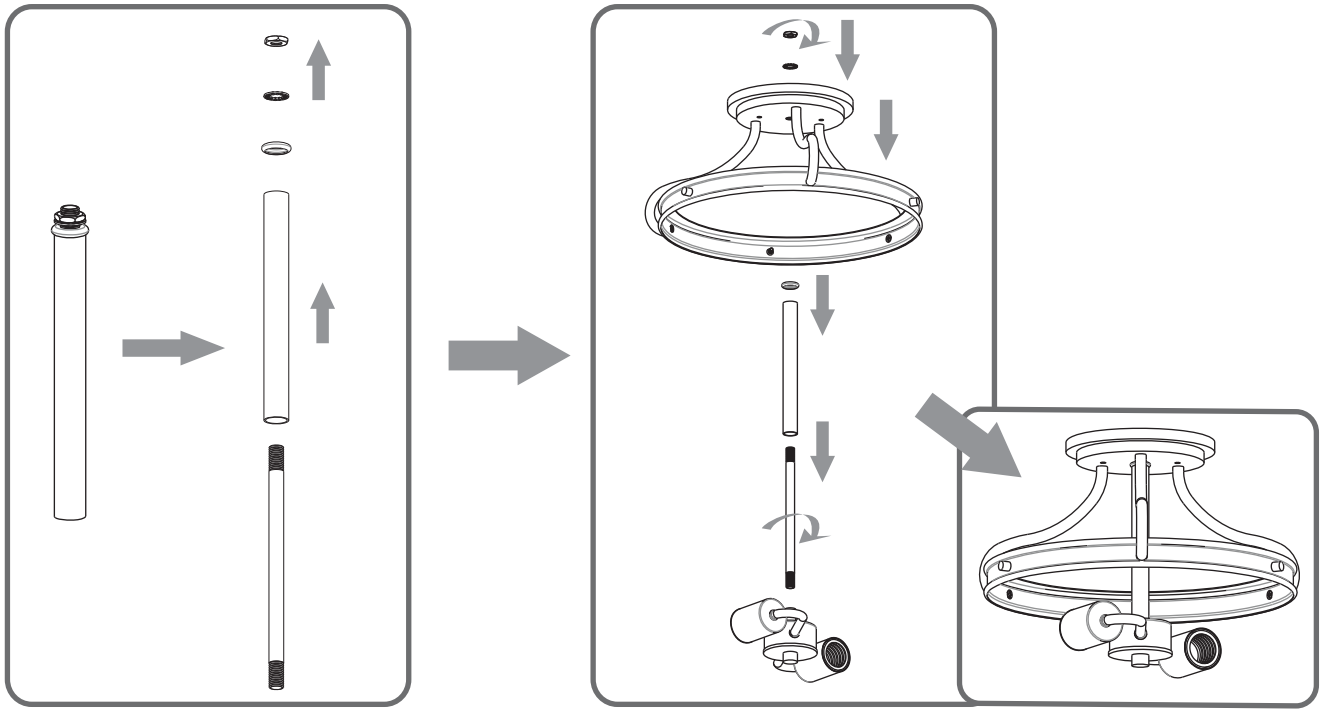

STEP 2

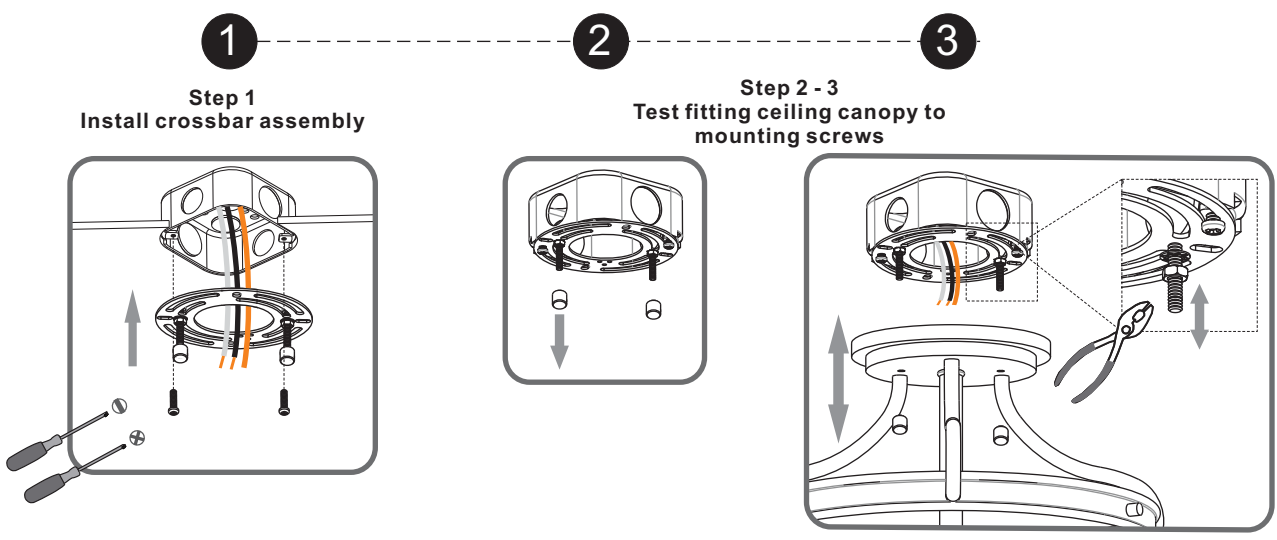

STEP 3

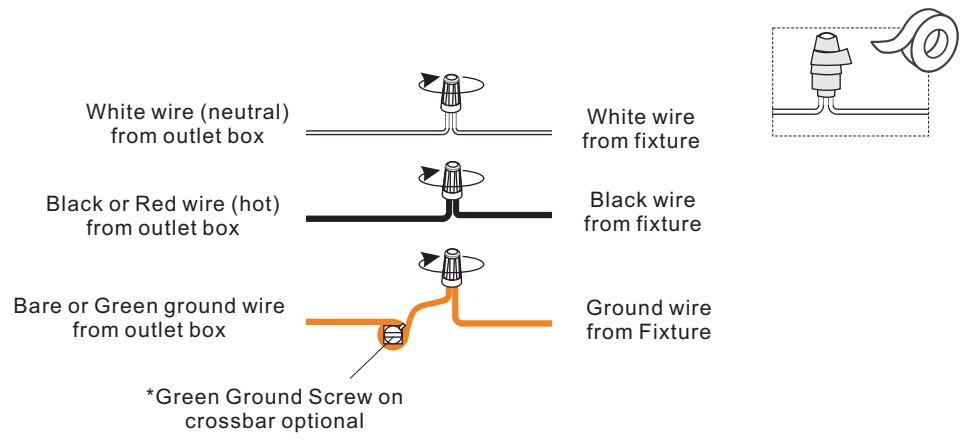

STEP 4

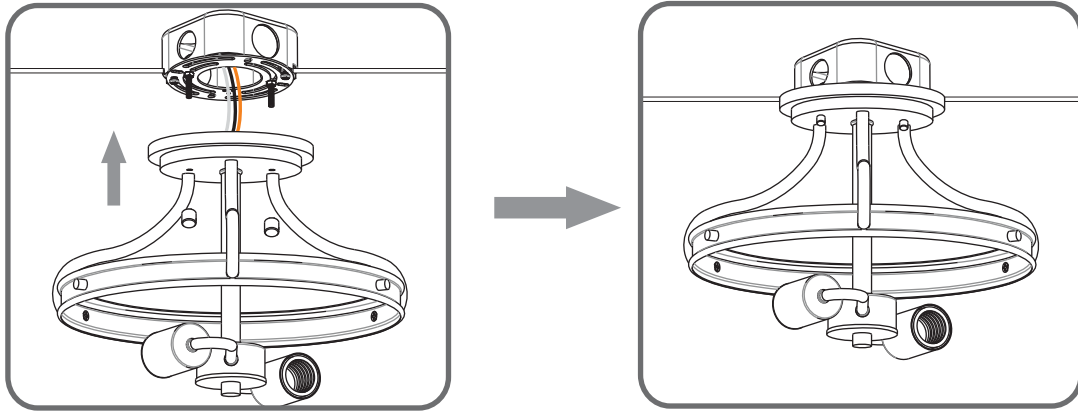

STEP 5

1

Remove Lock Screws

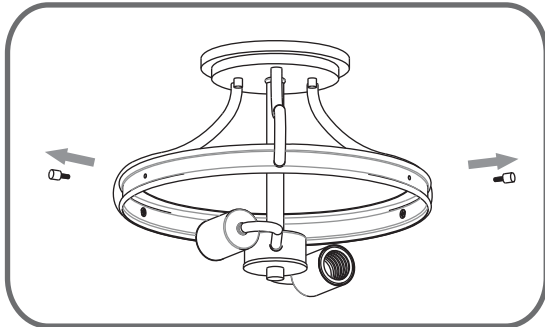

2

Install Shade

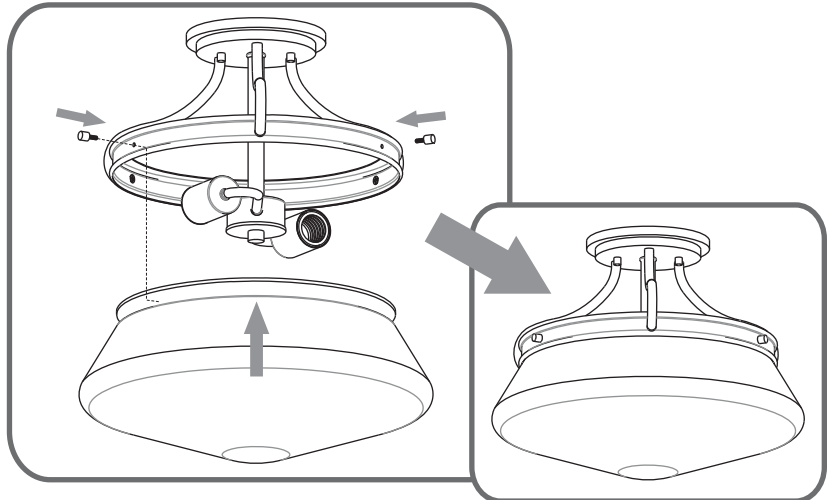

STEP 6

