

**Tools Required**

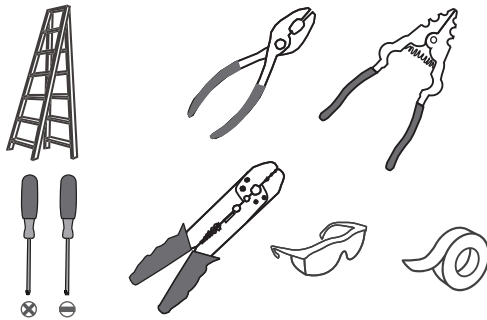

**Light Source**

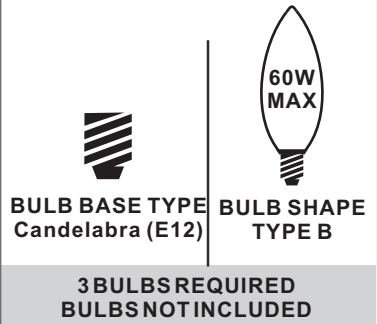

**Warnings and Cautions**

Turn off the electricity at the circuit breaker before installation. Consult a licensed electrician if in doubt about installation.

Turn off power to the fixture and allow the bulbs to cool before replacing.

**Package Contents**

**Preparation:** Identify and inspect all parts before beginning the installation.

Missing or damaged parts? Contact your original place of purchase.

**PARTS BAG**

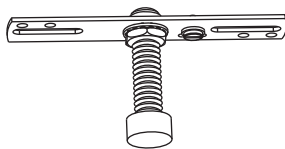

**A** Crossbar Assembly x 1



**B** Outlet Box Screw x 2



**C** Wire Connector x 3

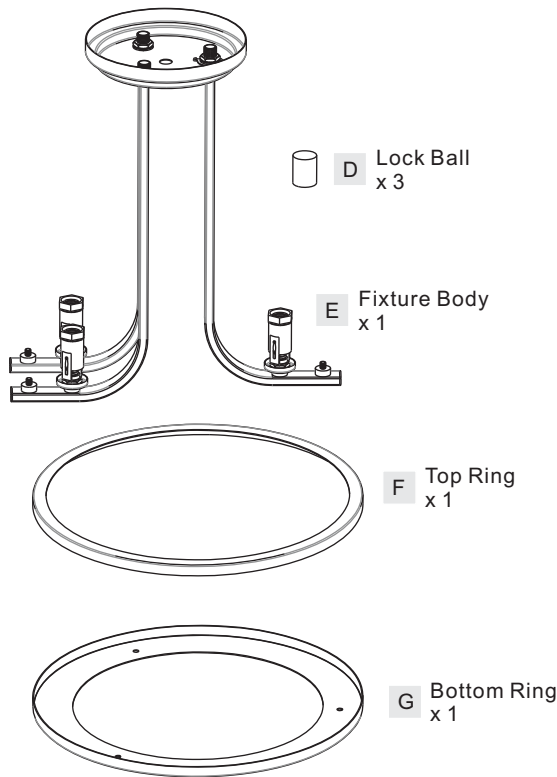

**D** Lock Ball x 3

**E** Fixture Body x 1

**F** Top Ring x 1

**G** Bottom Ring x 1

**Note:** Shade shape is for illustration purpose only. Your shade shape may vary from illustration.

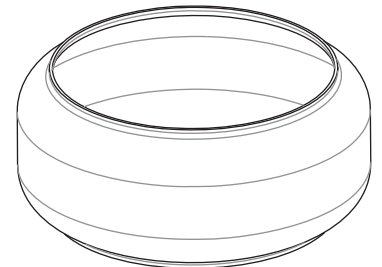

**H** Shade (Varies according to style purchased) x 1



**I** Candle Cover x 3

**Table of Contents**

Unfold Arms	Crossbar Assembly	Bottom Ring	Shade & Top Ring	Wiring	Ceiling Canopy	Candle Covers & Bulbs
<b>STEP 1</b>	<b>STEP 2</b>	<b>STEP 3</b>	<b>STEP 4</b>	<b>STEP 5</b>	<b>STEP 6</b>	<b>STEP 7</b>

## STEP 1

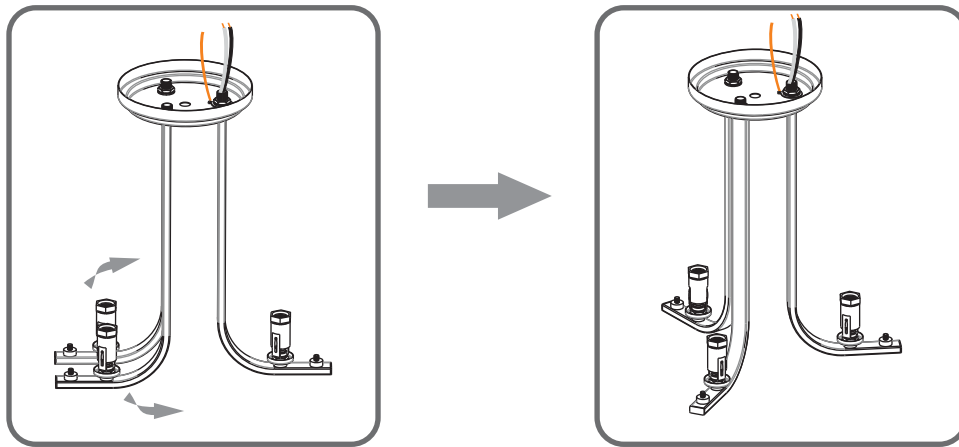

## STEP 2

1

Step 1  
Install crossbar assembly

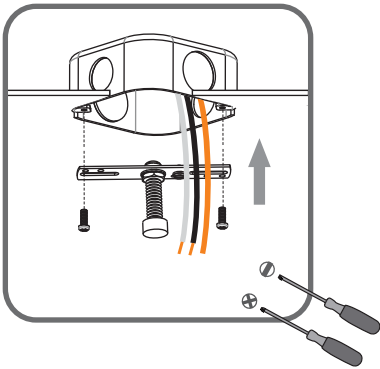

2

Step 2 - 3  
Test fitting ceiling canopy to nipple

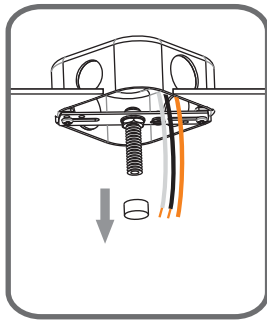

3

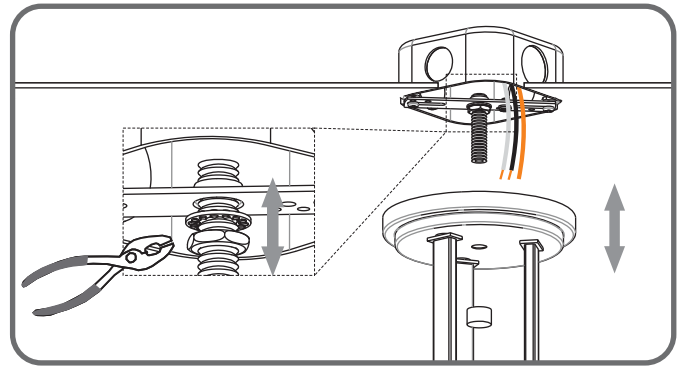

## STEP 3

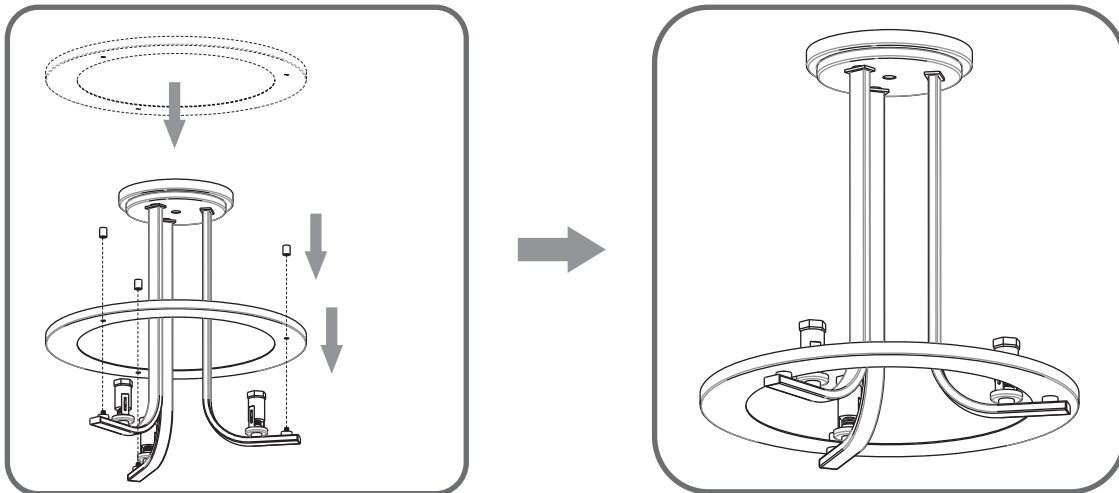

### STEP 4

Note: Shade shape is for illustration purpose only. Your shade shape may vary from illustration.

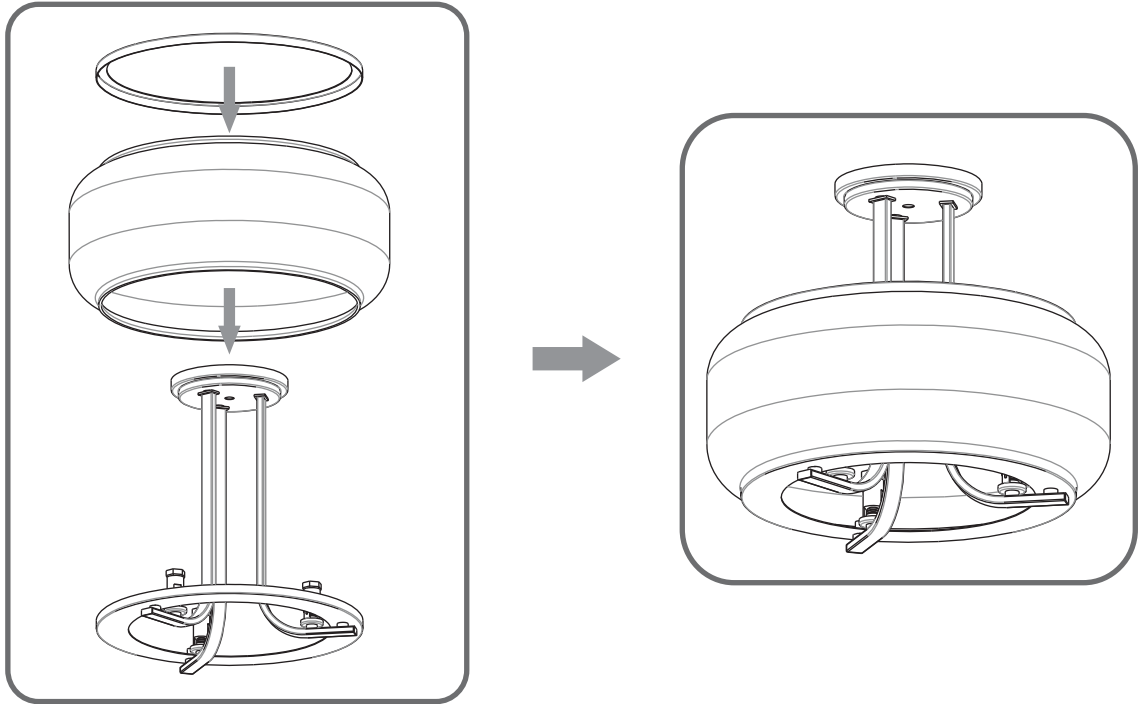

### STEP 5

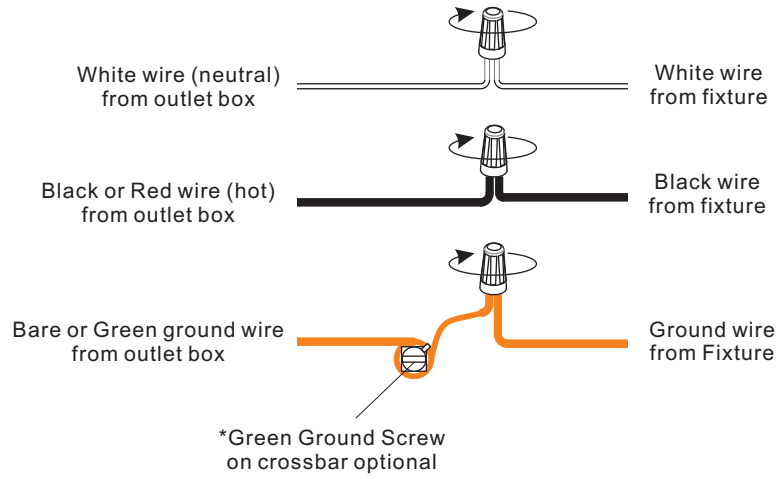

### STEP 6

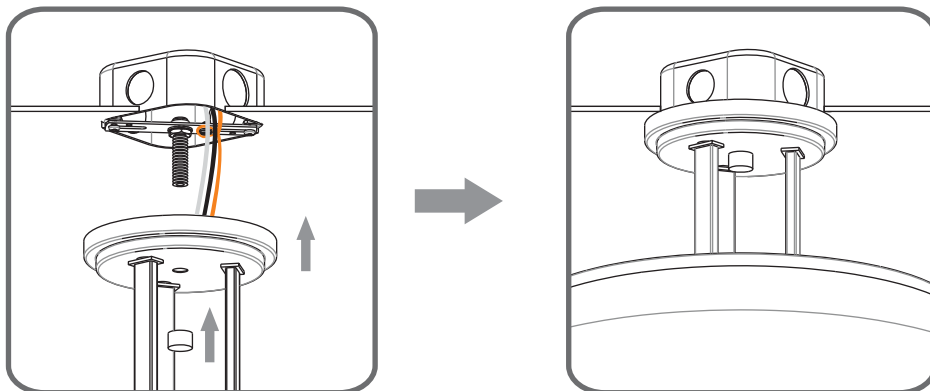

**STEP 7**

