

Tools Required

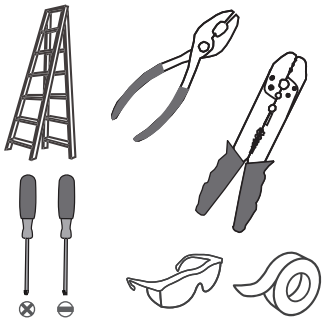

Light Source

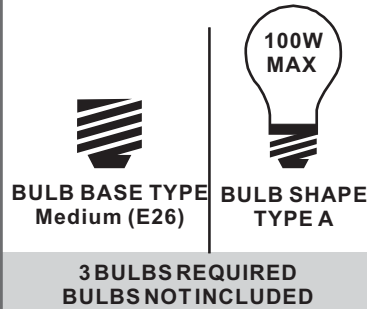

Warnings and Cautions

Turn off the electricity at the circuit breaker before installation. Consult a licensed electrician if in doubt about installation.

Turn off power to the fixture and allow the bulbs to cool before replacing.

Package Contents

Preparation: Identify and inspect all parts before beginning the installation.

Missing or damaged parts? Contact your original place of purchase.

Note: Shade shape is for illustration purpose only. Your shade shape may vary from illustration.

PARTS BAG

A Mounting Screw x 4

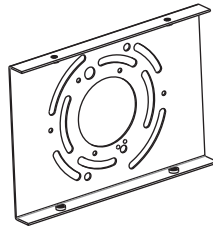

B Inner Backplate x 1

C Outlet Box Screw x 2

D Wire Connector x 3

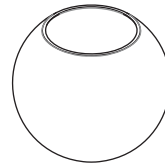

E Shade (Varies according to style purchased) x 3

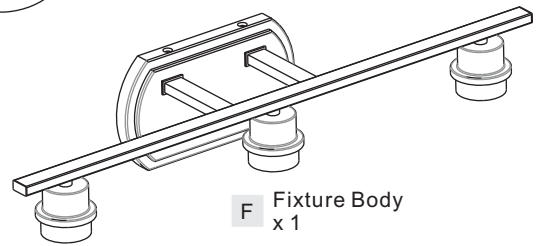

F Fixture Body x 1

Table of Contents

Inner Backplate	Wiring	Fixture Body	Shade & Bulb
STEP 1	STEP 2	STEP 3	STEP 4

STEP 1

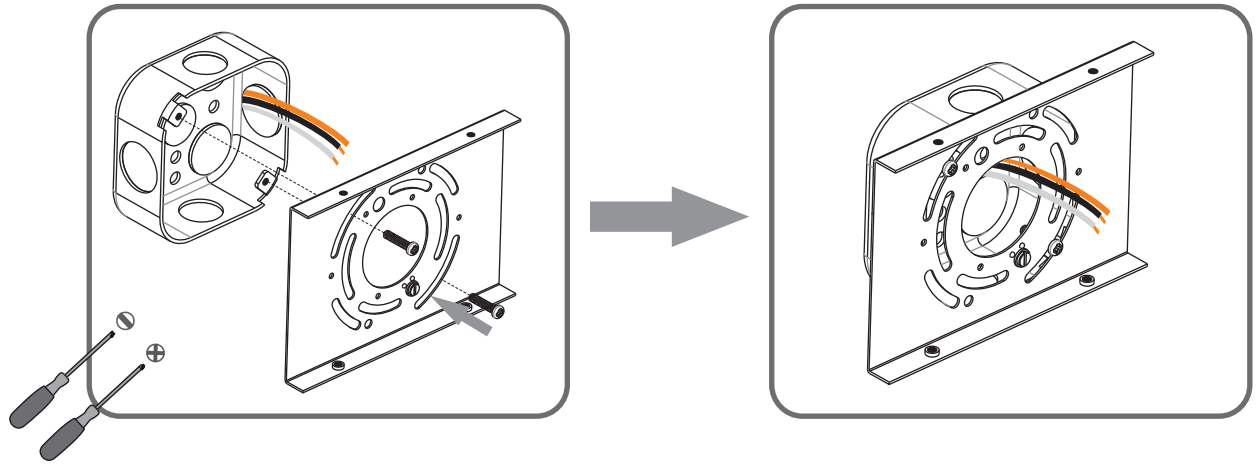

STEP 2

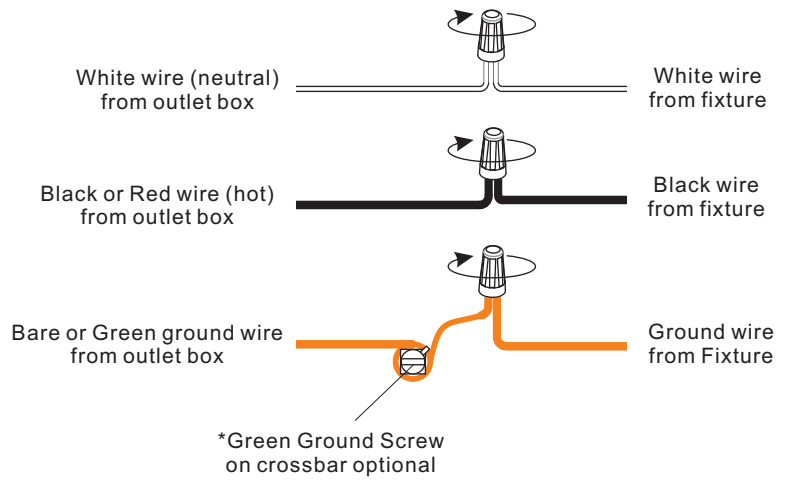

STEP 3

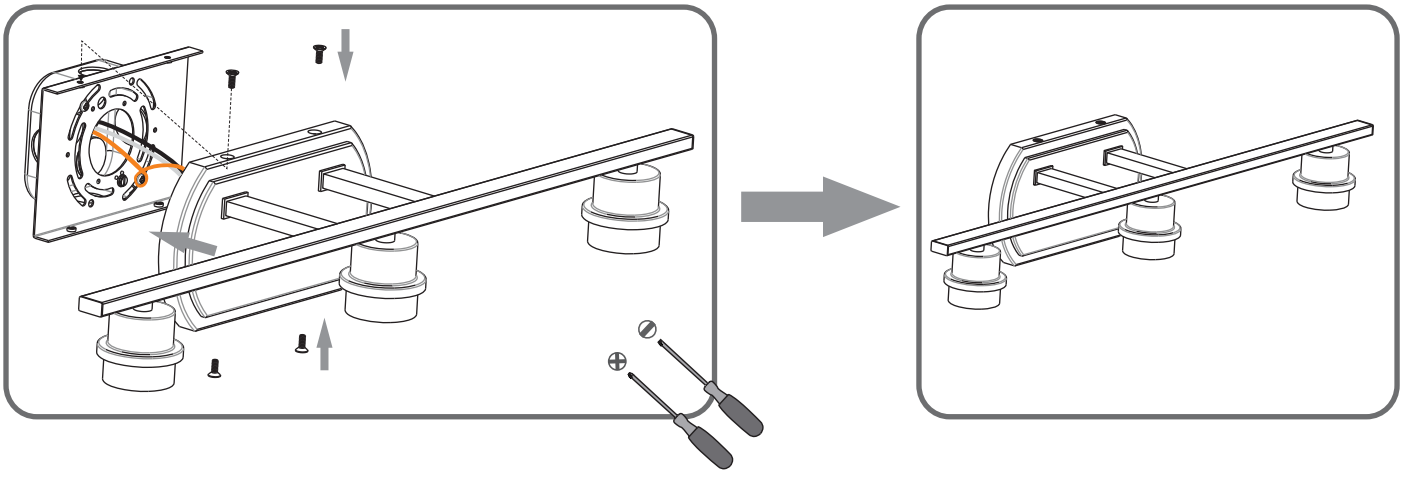

STEP 4

1

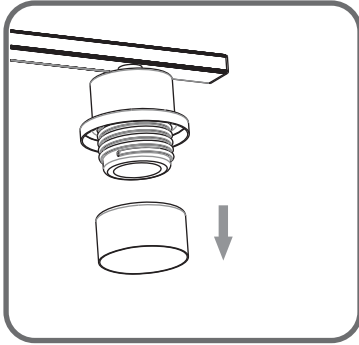

2

Note: Shade shape is for illustration purpose only. Your shade shape may vary from illustration.

