

Tools Required

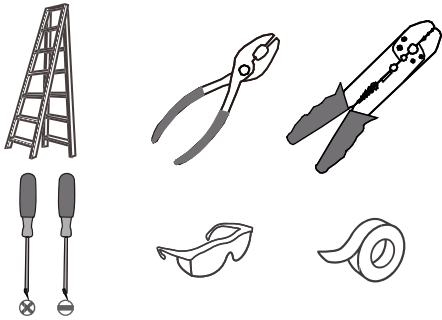

Light Source

19W
LED

⚠ Warnings and Cautions

Turn off the electricity at the circuit breaker before installation. Consult a licensed electrician if in doubt about installation.

Package Contents

Preparation: Identify and inspect all parts before beginning the installation.

Missing or damaged parts? Contact your original place of purchase.

PARTS BAG

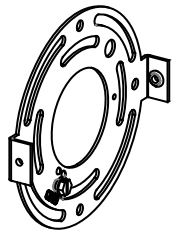

A Crossbar
x 1

B Mounting Screw
x 2

C Outlet Box Screw
x 2

D Wire Connector
x 3

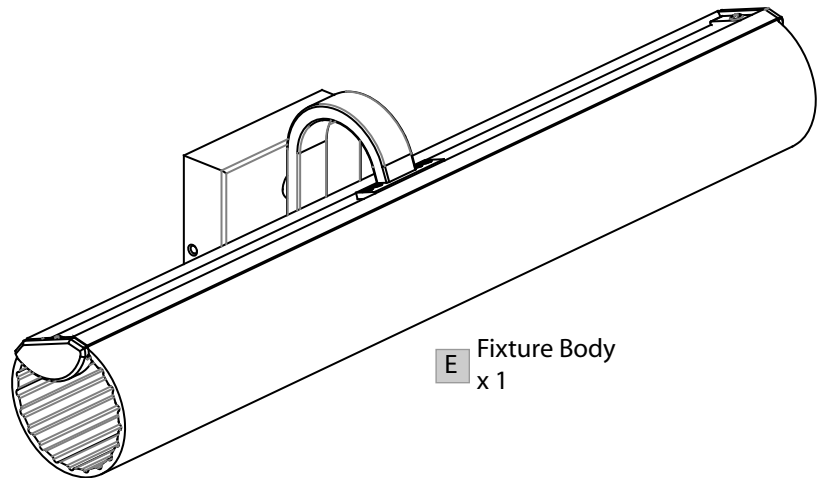

E Fixture Body
x 1

Table of Contents

Crossbar

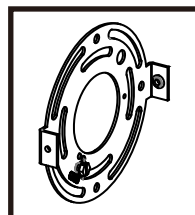

STEP 1

Wiring

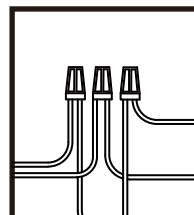

STEP 2

Fixture Body

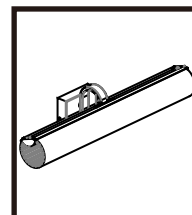

STEP 3

STEP 1

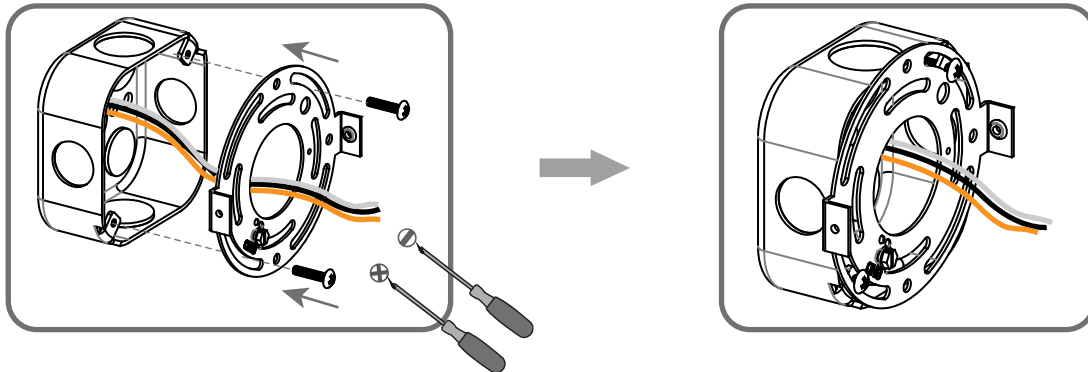

STEP 2

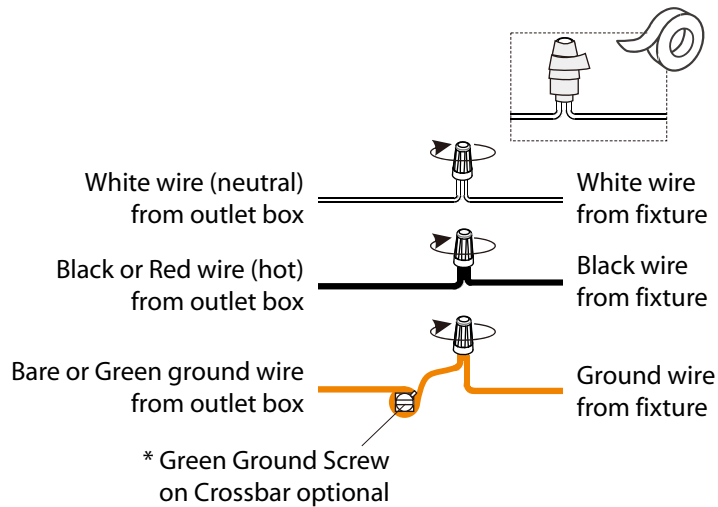

STEP 3

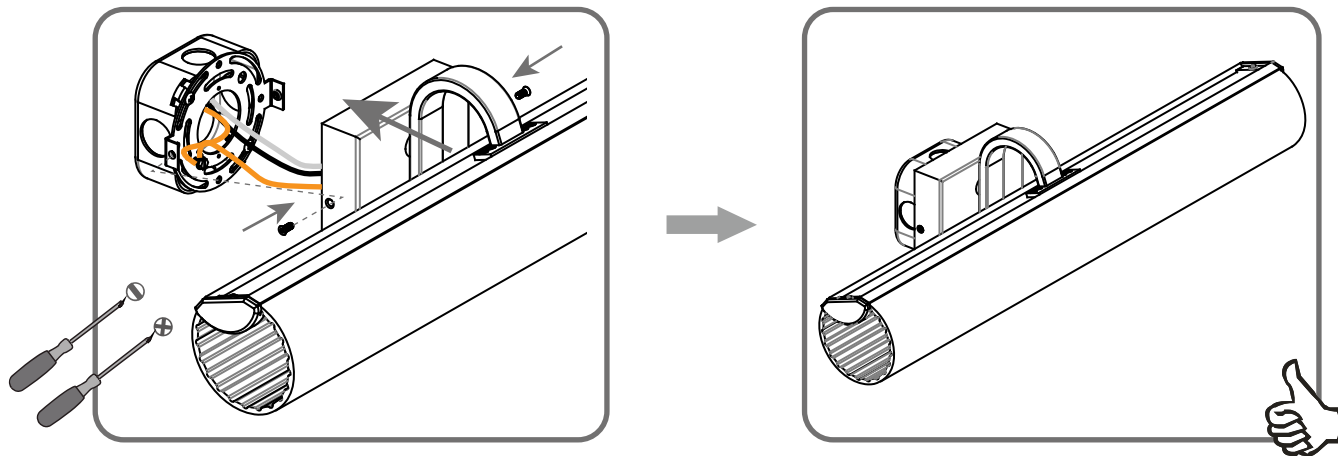

How To Replace Shade

Place the fixture body onto a flat working surface to process this procedure.

1

remove end cap on one end

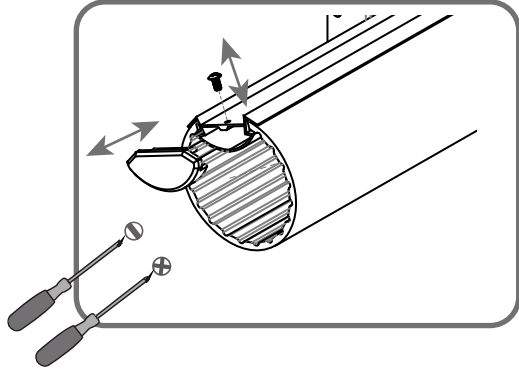

install the removed end cap back

3

2

replace the shade

