

Tools Required

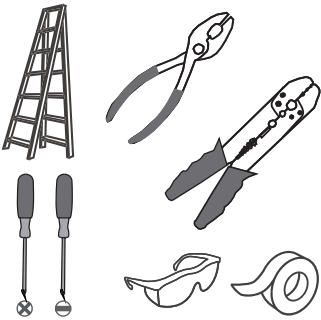

Light Source

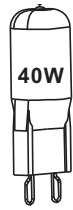

G9 Xenon Bulb

**2 BULBS REQUIRED
BULBS NOT INCLUDED**

⚠ Warnings and Cautions

Turn off the electricity at the circuit breaker before installation. Consult a licensed electrician if in doubt about installation.

Turn off power to the fixture and allow the bulbs to cool before replacing.

Package Contents

Preparation: Identify and inspect all parts before beginning the installation.

Missing or damaged parts? Contact your original place of purchase.

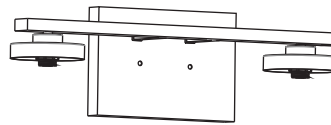

E Fixture Body x 1



F Shade x 2

PARTS BAG

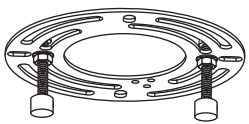

A Crossbar Assembly x 1



B Alternate Mounting Screw x 2







C Outlet Box Screw x 2

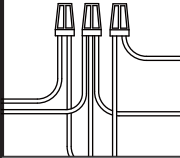

D Wire Connector x 3

Table of Contents

| Alternate Mounting Screw | Crossbar Assembly | Wiring | Fixture Body | Shade and Bulb |
|---|---|---|--|---|
|  |  |  |  |  |
| STEP 1 | STEP 2 | STEP 3 | STEP 4 | STEP 5 |

STEP 1

OPTION 1

Standard Mounting Screw

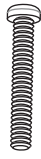

Included (Pre-assembled)

OPTION 2

Alternate Mounting Screw



Included

skip to next page

1

2

3

Steps 1-3 to remove standard mounting screws

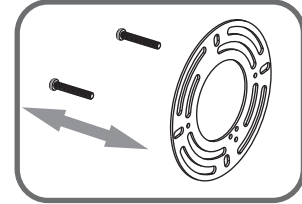
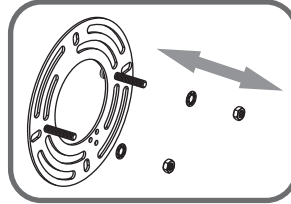
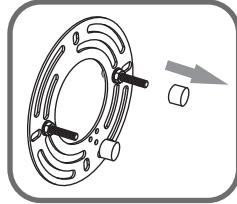

4

Steps 4-6 to reassemble with alternate mounting screws

6

5

STEP 2

1

2

3

Step 1
Install crossbar assembly

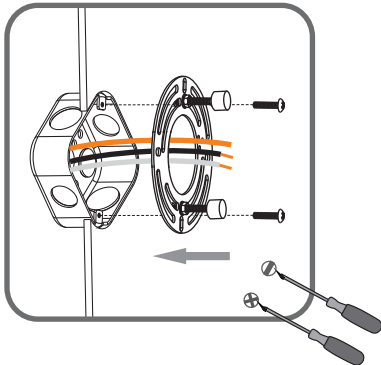

Step 2 - 3
Test fitting backplate to mounting screws

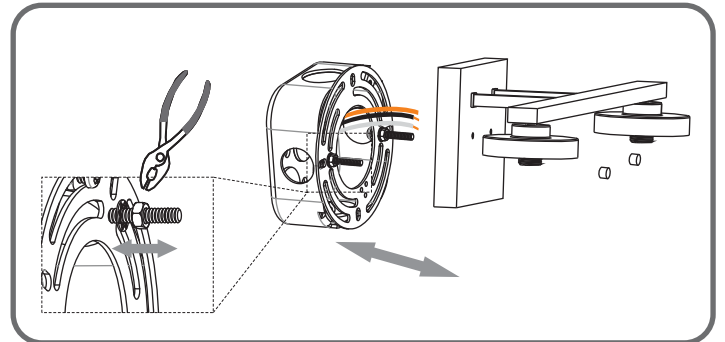
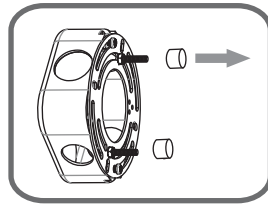

STEP 3

White wire (neutral)
from outlet box

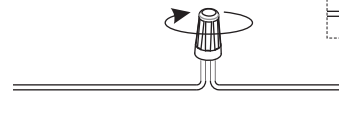

White wire
from fixture

Black or Red wire (hot)
from outlet box

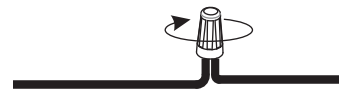

Black wire
from fixture

Bare or Green ground wire
from outlet box

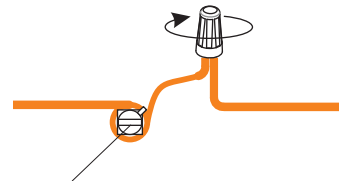

Ground wire
from Fixture

*Green Ground Screw
on crossbar optional

STEP 4

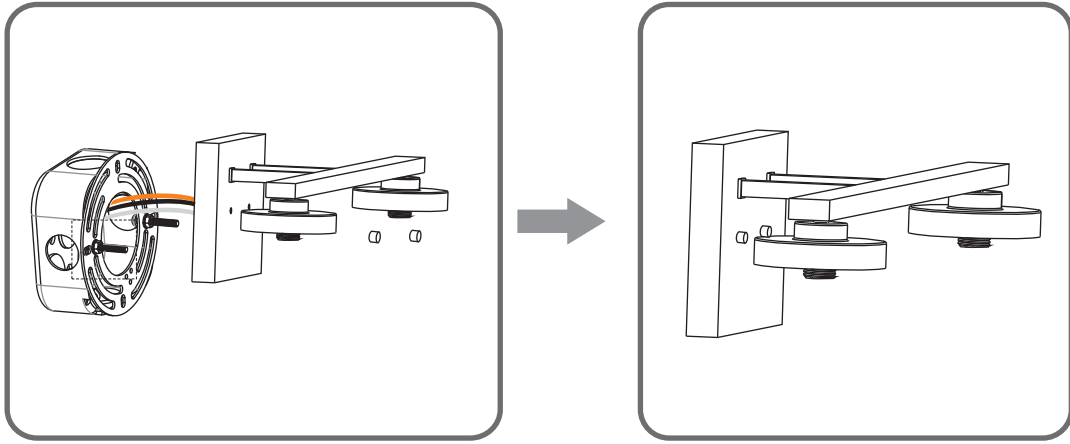

STEP 5

