

! SAFETY INFORMATION

Released Date: 2022-08-12

Please read and understand this entire manual before attempting to assemble, install or operate the product.

WARNING

- RISK OF ELECTRIC SHOCK - Before beginning installation, turn off electricity at the circuit breaker box or the main fuse box.
- RISK OF FIRE - Use bulbs specified by the markings and/or labels on the fixture.

CAUTION

- For your safety, read instructions completely before beginning installation.
- If in doubt about electrical installation, consult a licensed electrician.
- Turn off electricity to fixture before replacing the bulb(s).

TOOLS REQUIRED

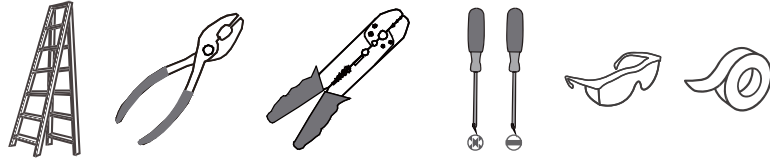

Ratings	120Vac, 60Hz	
	Model No.	Wattage
	FLX8412MBK	9W
	FLX8414MBK	11W

CARE AND MAINTENANCE

- Wipe clean using soft, dry cloth or static duster. Always avoid using harsh chemicals and abrasives to clean fixture as they may damage the finish.

If you need further assistance call Quoizel Customer Care at 1-800-645-3184 (9:00am - 5:00pm EST), or visit us on-line at www.quoizel.com.

PACKAGE CONTENTS

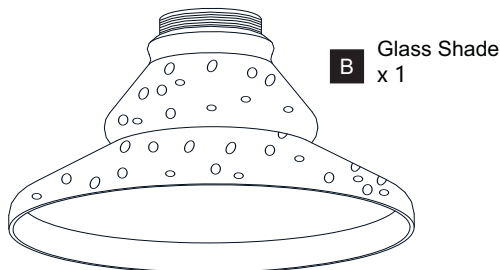
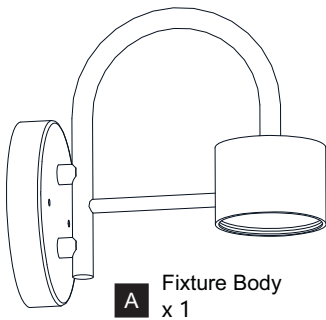

MOUNTING HARDWARE

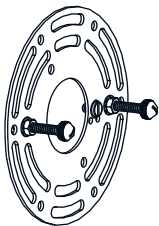

INSTALLATION

1 Install Crossbar Assembly

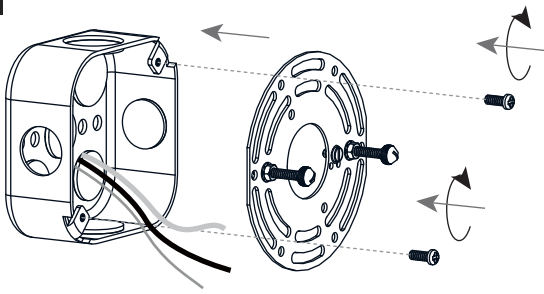

(2) Alternative Screws



* Alternative screws are provided to replace pre-assembled mounting screws if necessary.

2 Wiring

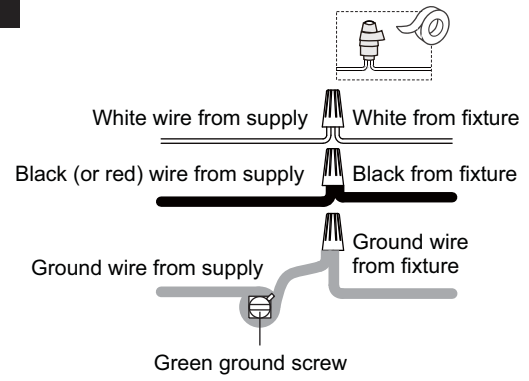

3 Install Fixture Body

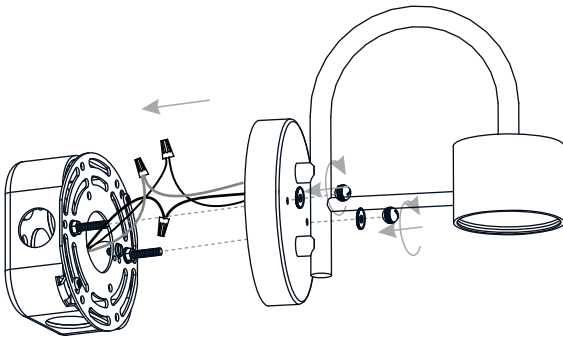

4 Install Glass Shade

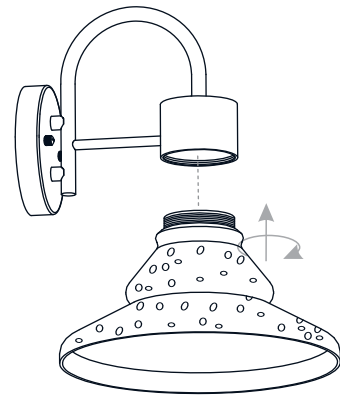

5 Apply Caulking

* Note: Do NOT caulk the bottom of the backplate to allow moisture to escape.

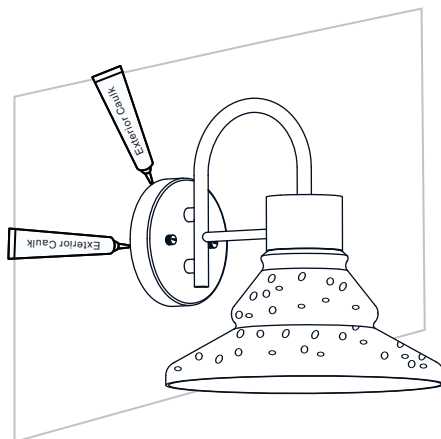

Your installation is now complete! Restore electricity and save this sheet for future reference.