

**Tools Required**

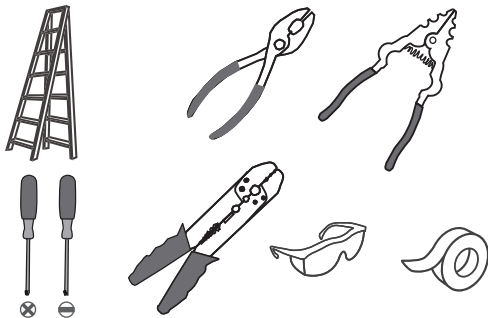

**Light Source**

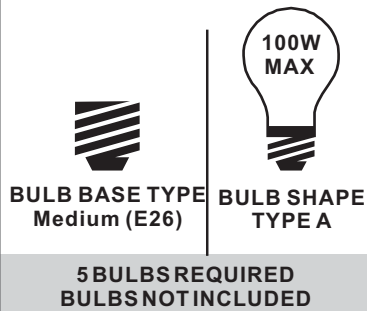

Option 1 (socket up): Fixture Height Adjustable 25" to 72"

Option 2 (socket down): Fixture Height Adjustable 29.5" to 76.5"

**Warnings and Cautions**

Turn off the electricity at the circuit breaker before installation. Consult a licensed electrician if in doubt about installation.

Turn off power to the fixture and allow the bulbs to cool before replacing.

**Package Contents**

**Preparation:** Identify and inspect all parts before beginning the installation.

Missing or damaged parts? Contact your original place of purchase.

**PARTS BAG**

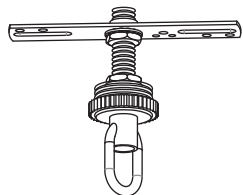

**A** Crossbar Assembly x 1



**B** Outlet Box Screw x 2



**C** Wire Connector x 3

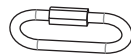

**D** Quick Link x 2

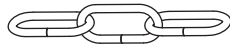

**E** Fixture Chain x 1

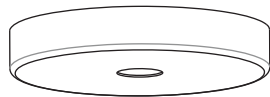

**F** Ceiling Canopy x 1

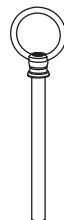

**G** Fixture Loop Assembly x 1

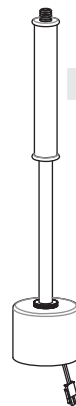

**H** Center Column x 1



**I** Stem with Hex Nut x 1



**J** Hex Nut x 2



**K** Socket Collar x 5

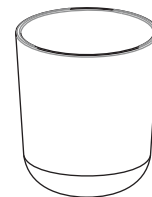

**L** Shade x 5

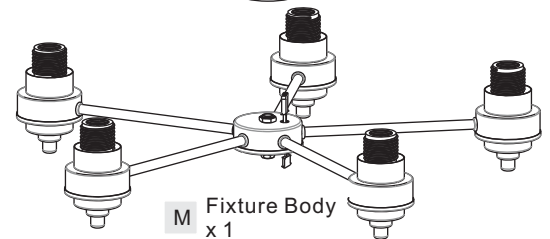

**M** Fixture Body x 1



**N** Cap x 1



**O** Check Ring x 1



**P** Finial x 1

**Table of Contents**

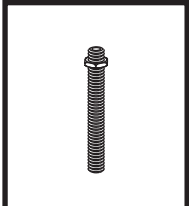
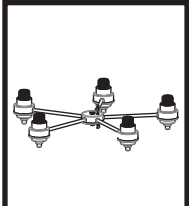
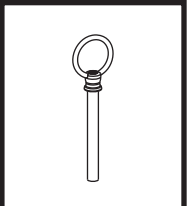
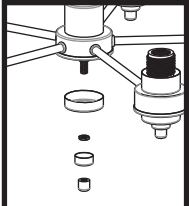
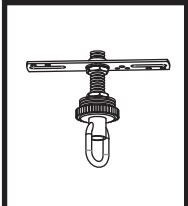
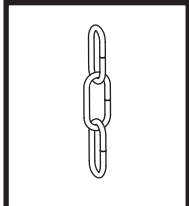
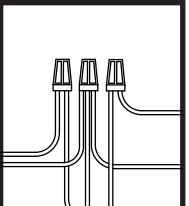
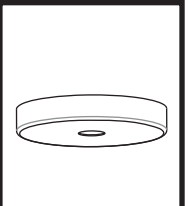
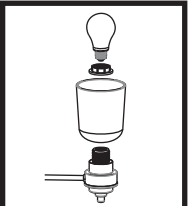
| Stem with Hex Nut   | Fixture Body  | Fixture Loop Assembly  | Cap   | Crossbar Assembly   |
|---|---|--|---|---|
|  |  |  |  |  |
| <b>STEP 1</b>   | <b>STEP 2</b>   | <b>STEP 3</b>  | <b>STEP 4</b>   | <b>STEP 5</b>   |
|  |  |  |  |   |
| <b>STEP 6</b>   | <b>STEP 7</b>   | <b>STEP 8</b>  | <b>STEP 9</b>   |   |
| <b>Fixture Chain</b>  | <b>Wiring</b>   | <b>Ceiling Canopy</b>  | <b>Shade &amp; Bulb</b>   |   |

STEP 1

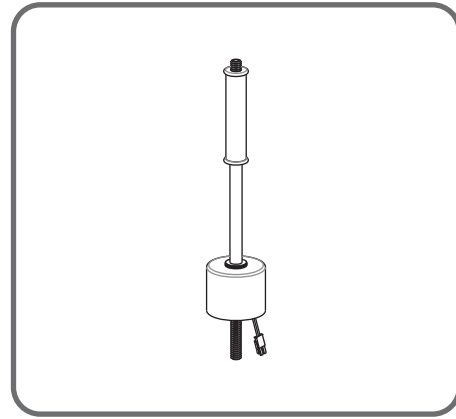
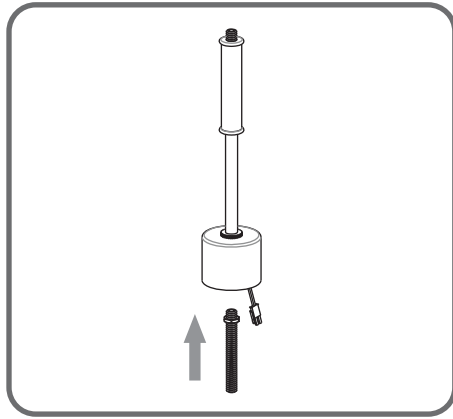

STEP 2

OPTION 1

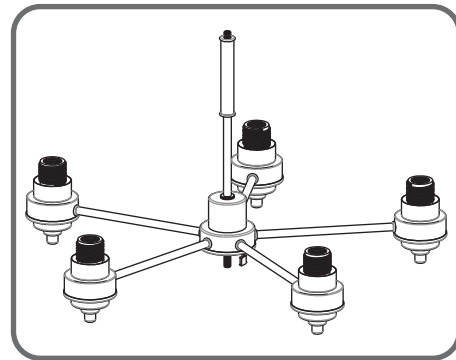
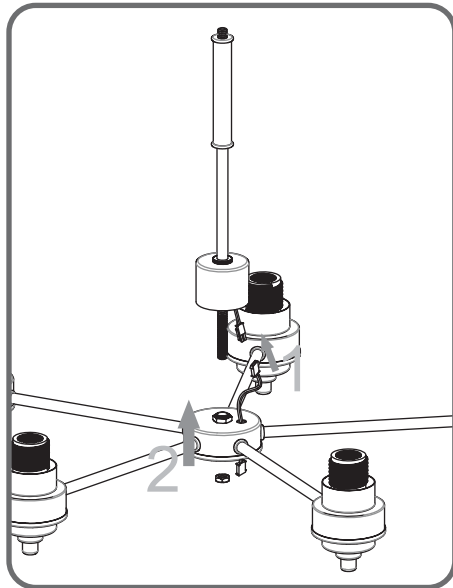

OPTION 2

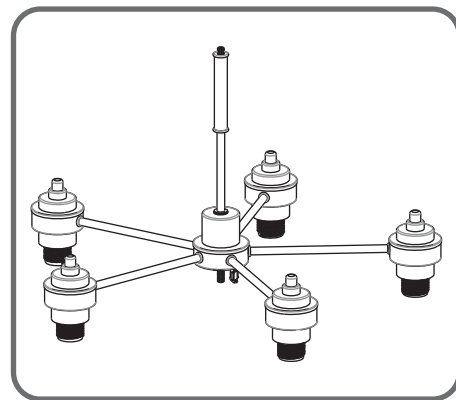
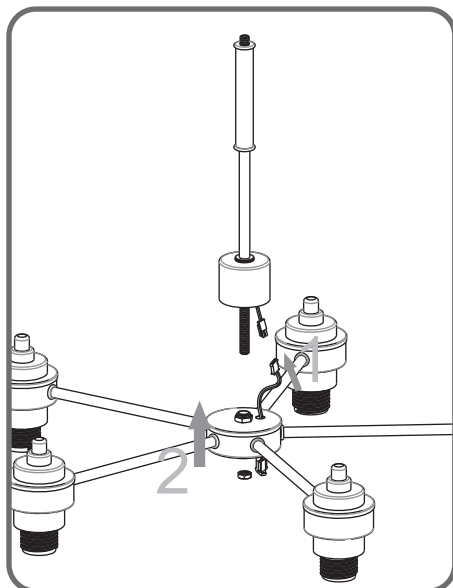

**STEP 3**

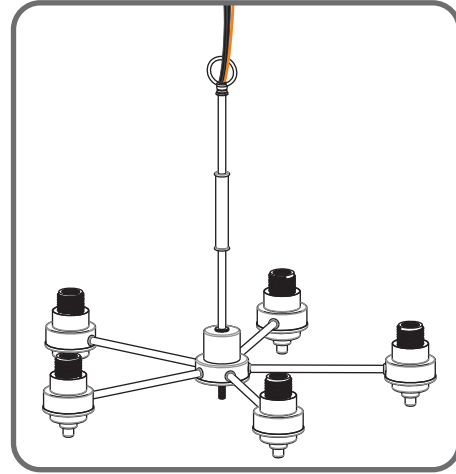
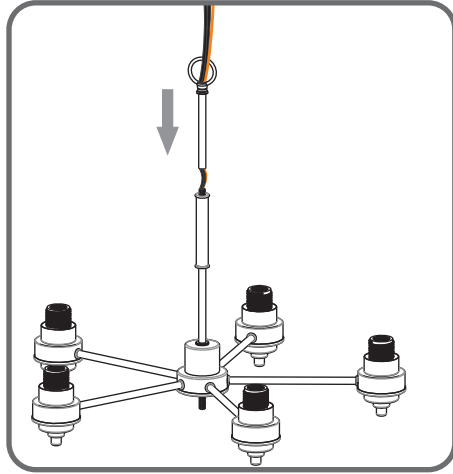

**STEP 4**

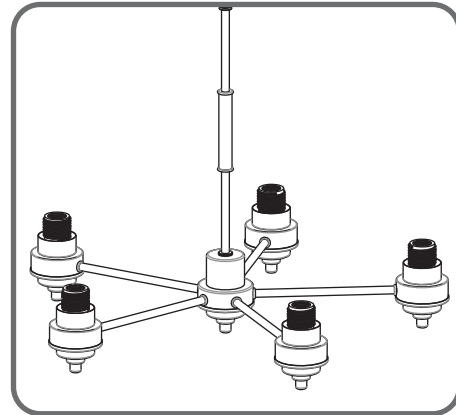
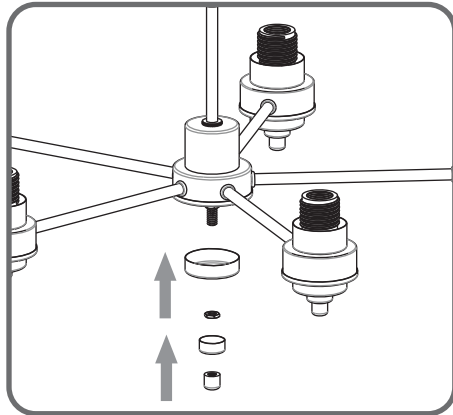

**STEP 5**

1

**Step 1**  
Install crossbar assembly

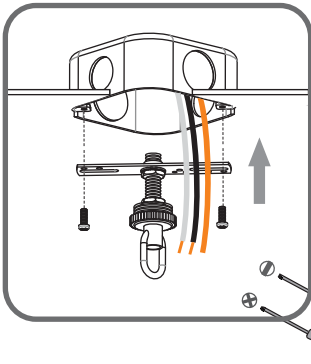

2

**Step 2 - 3**  
Test fitting ceiling canopy to nipple

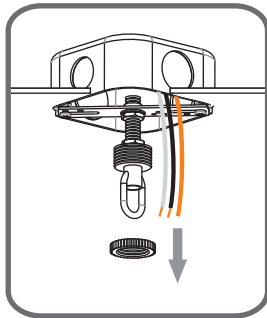

3

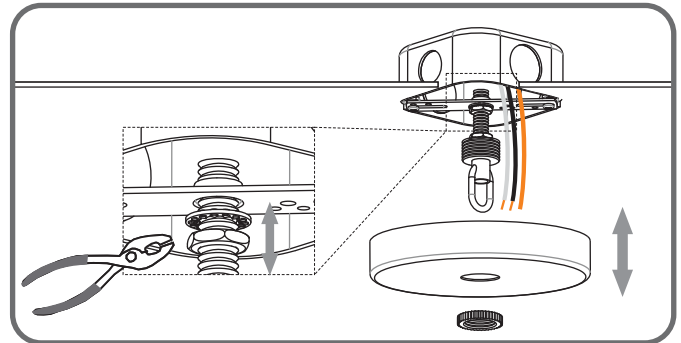

## STEP 6

1

Step 1  
Adjust fixture chain length

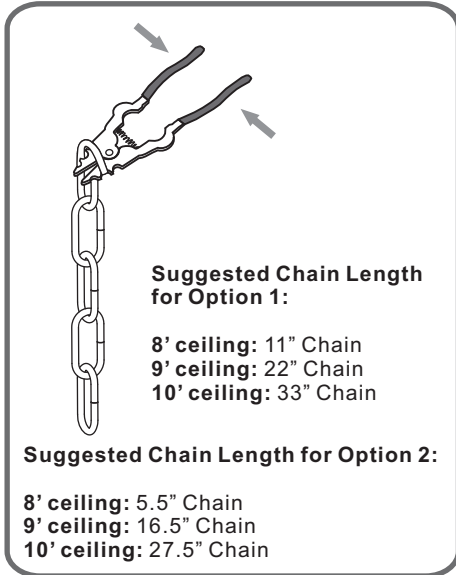

2

Step 2 - 3  
Install Fixture Chain

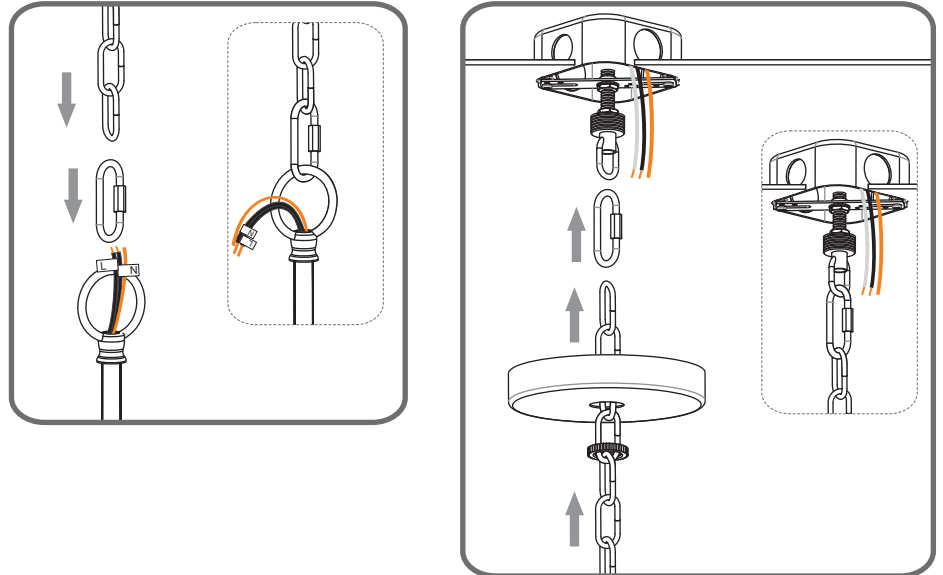

## STEP 7

1

Step 1  
Feed the fixture wires through the loop

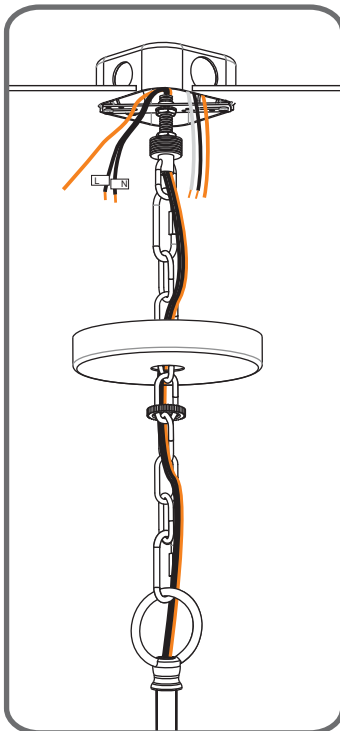

2

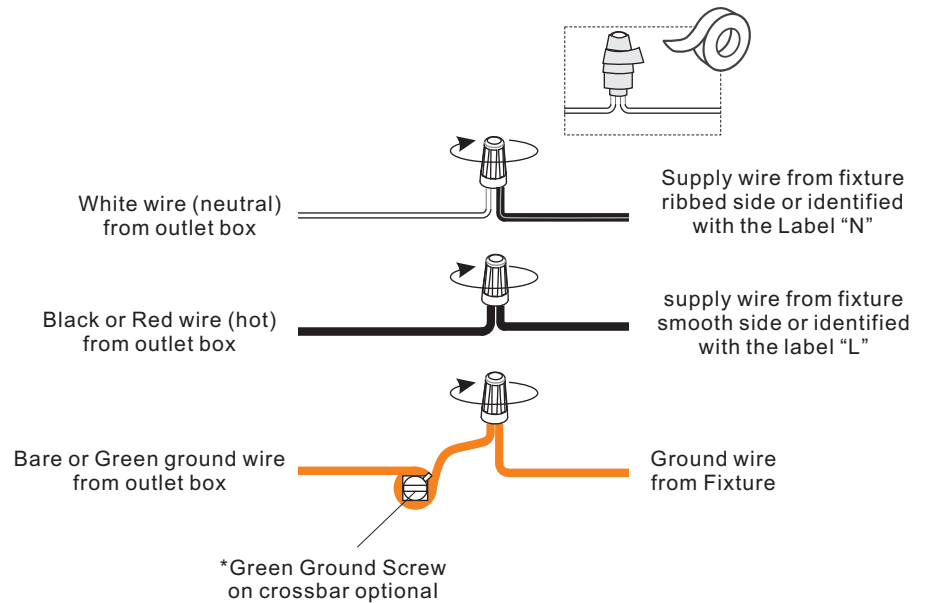

**STEP 8**

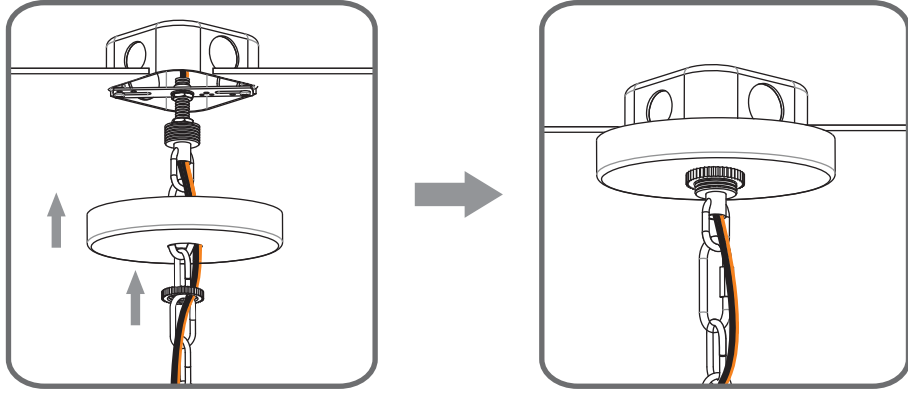

**STEP 9**

