

INSTALLATION INSTRUCTION

For Outdoor Lantern Item#8603-A179 (New. 04/30/2019)

READ AND SAVE THESE INSTRUCTIONS

WARNING! SHUT POWER OFF AT FUSE OR CIRCUIT BREAKER.

AVERTISSEMENT! COUPER LE COURANT AU NIVEAU DES FUSIBLES OU DU DISJONCTEUR.

PREPARATION (Fig. 1)

1. Shut off power at the fuse box or circuit breaker box and remove the old fixture including the mounting hardware.
2. Carefully unpack your new fixture and lay out all the parts in a clear area. Take care not to misplace any small parts necessary for installation.
3. Attach the crossbar (B) to the junction box (A) with the junction box screws (C) (Size: #8-32N*L0.5") as shown. The side of the crossbar marked "GND" must face out.
4. Thread the nipple (D) part way into the center hole of the crossbar (B).

CONNECTING THE WIRES (Fig. 2)

5. Connect the electrical wires as shown in Fig. 2, making sure that all wire connectors are secured. If your outlet box has a ground wire (green or bare copper), connect the fixture's ground wire to it. Otherwise, connect the fixture's ground wire directly to the crossbar using the green screw provided. After the wires are connected carefully tuck them inside the Junction box.

COMPLETING THE INSTALLATION

6. Install backplate of the fixture body (E) over nipple (D) and secure with cap nut (F).
7. To prevent moisture from entering the outlet box and causing a short, use clear caulking (i.e. Indoor/Outdoor Silicone Sealant) to outline the outside of fixture back-plate where it meets the wall leaving a space at bottom to allow moisture a means to escape (Fig.3).
8. Install (1) one medium base bulb (G) up to 100 watts or CFL or LED equivalent (not included) in accordance with the fixture specification. — **DO NOT EXCEED THE MAXIMUM WATTAGE RATING! (NE PAS DEPASSER LA PUISSANCE NOMINALE MAXIMALE!)**

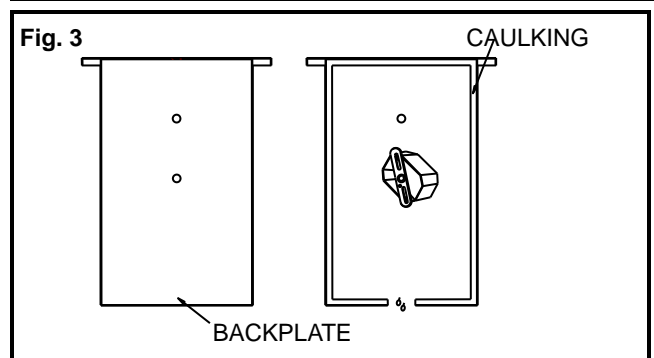
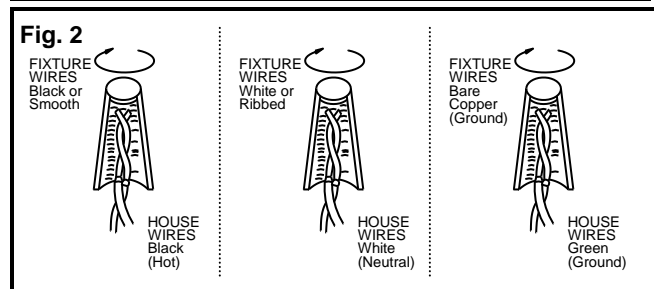
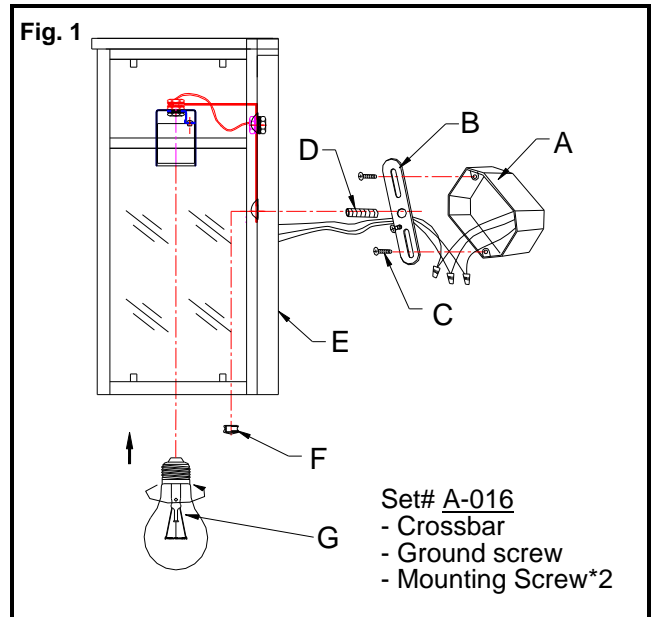

Your installation is now complete. Return the power to the junction box and test the fixture.

Note: Illustration (Fig. 1) on this manual is for installation purposes only. It may or may not be identical to the fixture purchased.