

## ▲ WARNING

### RISK OF ELECTRIC SHOCK

- Do not use in wet location
- Use indoors only
- Turn power off before servicing -see instructions
- Properly ground fixture
- Ensure that no bare wires are exposed outside The electrical connections

### BULB MAY SHATTER AND CAUSE INJURY IF BROKEN

- Do not use excessive force when installing bulb

### RISK OF BURN

- Allow bulb to cool before handing.

## INSTALLATION PROCEDURES

1:TURN OFF THE ENTIER ELECTRICAL CIRCUIT TO WHICH THE LIGHTING FIXTURE IS TO BE ATTACHED.

Move the circuit breaker to the OFF position or completely remove the fuse controlling the circuit

2 Determine the desired location for mounting the fixture, Measure the distance between the Centers of the 2 keyholes On the back of the fixture. Mark the location of the keyholes on the underside of the cabinet with a pencil. Drill pilot Holes for the mounting screws approx. 1/4 away from the cabinet. Not :if you plan on joining fixture end to end in a run. Remove the safety covers with a common screwdriver on each of your fixtures. Align the ends of the fixtures And press the quick-link firmly together on all of the fixtures in your run. Measure the distance between all of The keyholes in you run. Mark the location and Drill pilot holes. Determine the desired power Feed for You fixture, Portable ,Hardwire or Master Switch cat.#NCS-1Note: fixture come pre-wired as portable , if Plan on using this fixture as a portable skip to step 6

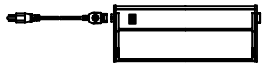

Portable :MXinterlink3,  
Connector Cord  
87856-87858 WT.BK



Hardwire: to be used with Flex,Roomex&  
Right Conduit (Provided by others)  
MXInterLink3 direct Wire Box 87850 WT.BK

3. If hardwiring remove the lens pressing down on tell symbol on each of the glass lens and pull forward Remove the wireway cover removing the two screws on opposite ends of the fixture and compressing the wireway Tubs. Remove the desired knockout from the back of the fixture and install the conduit /romex clam/connector
4. Feed the supply wires through the fixture into the wireway compartment. Mount the fixture to the cabinet. Do not Tighten the screw at the time ,there will be 3 push-in quick connectors located in the wirewaycompartment, 1 Common (white), 1 hot (black) and 1 ground (green). Connect the black supply wire to the black push-in connector, White to white and green to green.
5. Adjust the supply leads inside and outside of the fixture. Tighten the screws on the conduit/romex clamp. Replace the Wireway cover removed in step 3
6. Securely tighten the mounting screw. Note: if mounting and to end the entire run must be mounted together Connect each fixture end and mount to the cabinet as a run. When adding additional fixture to a portable fixture.. they only can be added to the right of you power feed fixture. When adding additional Fixture to a hardwire fixture, they can be added on both the left and the right of your power feed fixture Install the lamp(bulbs).
7. install the lamps (bulbs).
8. Replace the lens on your fixture(s).
9. If you power feed fixture is being used as a portable unit plug in your portable cord &plug into the left end of Yours Power feed fixture and then into the outlet providing power to your fixture.
10. When using the interlink Cables to joint fixture together, follow step1-3 and steps 7-9 to install additional fixture Make sure all of your fixture and securely tighten to the cabinet joint the fixture with the interlink cables
11. Restoe power to the circuit at fuse or breaker box. Note: once power is restored never use INTERLINK cables to Disconnect power ,if disconnecting fixture or cables s required ,the power must be shut off the fuse or Breaker box first

## OPENING DIFFUSER

- 1 Turn off fixture and allow to cool;
- 2 Please finger tip on tab of each diffuser and cap;
- 3 Slide top and diffuser forward;
- 4 lower the edge of diffuser.

## CLOSEING DIFFUSER

- 1 Swing edge of diffuser with tabs up forward fixture until pegs by tabs slip into slot At the end of fixture and caps;
- 2 slide top and diffuser towards rear of fixture to lock.

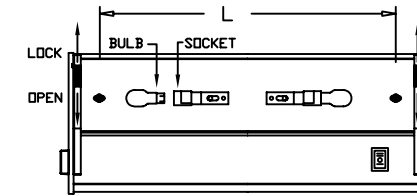

TYDE T5 12V 18W  
(Included)

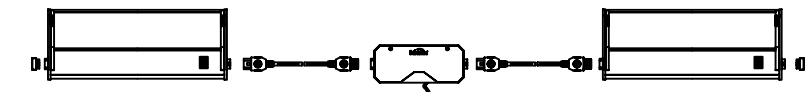
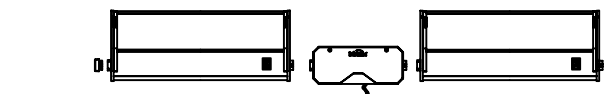
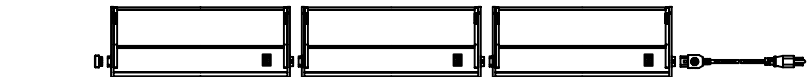
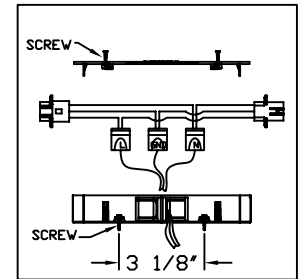
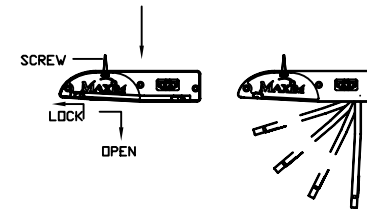

## ▲ WARNING

### RISK OF ELECTRIC SHOCK

- Do not use in wet location
- Use indoors only
- Turn power off before servicing -see instructions
- Properly ground fixture
- Ensure that no bare wires are exposed outside
- The electrical connections

### BULB MAY SHATTER AND CAUSE INJURY IF BROKEN

- Do not use excessive force when installing bulb
- RISK OF BURN
- Allow bulb to cool before handing.

## INSTALLATION PROCEDURES

1:TURN OFF THE ENTIER ELECTRICAL CIRCUIT TO WHICH THE LIGHTING FIXTURE IS TO BE ATTACHED.

Move the circuit breaker to the OFF position or completely remove the fuse controlling the circuit.

2 Determine the desired location for mounting the fixture, Measure the distance between the Centers of the 2 keyholes on the back of the fixture. Mark the location of the keyholes on the underside of the cabinet with a pencil. Drill pilot holes for the mounting screws approx  $\frac{1}{4}$ " away from the cabinet. Note :If you plan on joining fixture end to end in a run. Remove the safety covers on each of your fixtures. Align the ends of the fixtures and press the quick-link firmly together on all of the fixtures in your run. Measure the distance between all of the keyholes in you run. Mark the location and Drill pilot holes. Determine the desired Power Feed for your fixture, Portable ,Hardwire or Master Switch cat.#NCS-1, Note: fixture come pre-wired as portable .

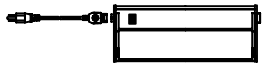

Portable :MXinterlink4,  
Connector Cord  
87876-87878 WT.BK  
Power Cord  
87880 WT.BK



MXInterLink4 direct Wire Box 87855 WT.BK

3. Securely tighten the mounting screw. Note: if mounting end to end the entire run must be mounted together. Connect each fixture end to end mount to the cabinet as a run. When adding additional fixture to a portable fixture, they only can be added to the right of your power feed fixture. When adding additional fixture to a hardwire fixture, they can be added on both the left and the right of your power feed fixture .

4. Install the lamps (bulbs).

5. Replace the lens on your fixture(s).

6. Plug in your portable cord & plug into the left end of your Power feed fixture and then into the outlet providing power to your fixture.

7. When using the interlink Cables to joint fixture together, follow step1-2 and steps 4-6 to install additional fixture. Make sure all of your fixture are securely tighten to the cabinet. Join the fixtures with the interlink cables.

8. Restore power to the circuit at fuse or breaker box. Note: once power is restored never use INTERLINK cables to Disconnect power, If disconnecting fixture or cables is required, the power must be shut off at the fuse or Breaker box first.

REMARKS: MXinterlink 4 Connector Cord 87877 and Direct Wire Box 87855 only Supply with Starter kit unit.  
Models : 87459, 87461, 87462, 87463. Other accessories are sold separately.

## OPENING DIFFUSER

- 1 Turn off fixture and allow to cool.
2. Unscrew screw 1.
- 3 Place finger tip on tab of each diffuser and cap;
- 4 Slide top and diffuser backward.
- 5 lower the edge of diffuser.

## CLOSING DIFFUSER

- 1 Swing edge of diffuser with tabs up toward fixture until pegs by tabs slip into slot at the end of fixture and caps;
- 2 slide top and diffuser towards front of fixture to lock.
3. Screw " screw 1".

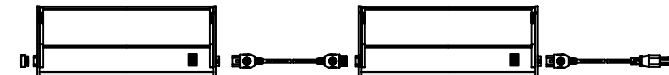
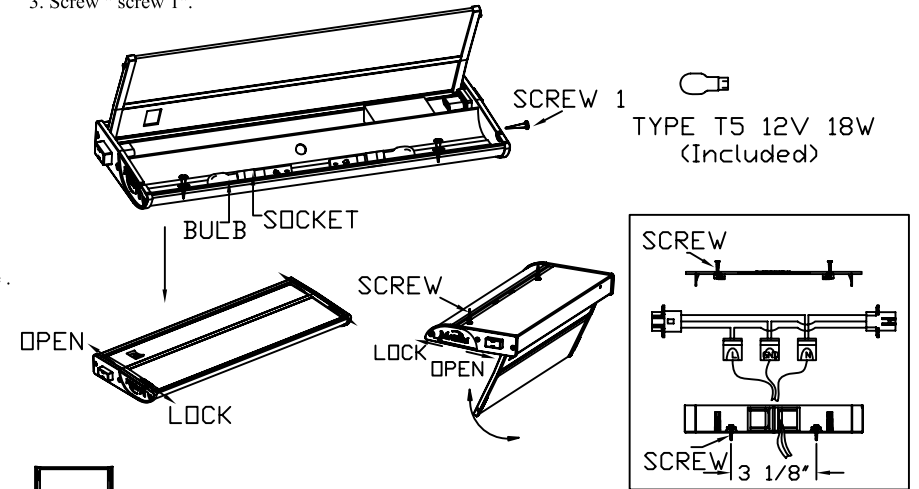

# MAXIM