

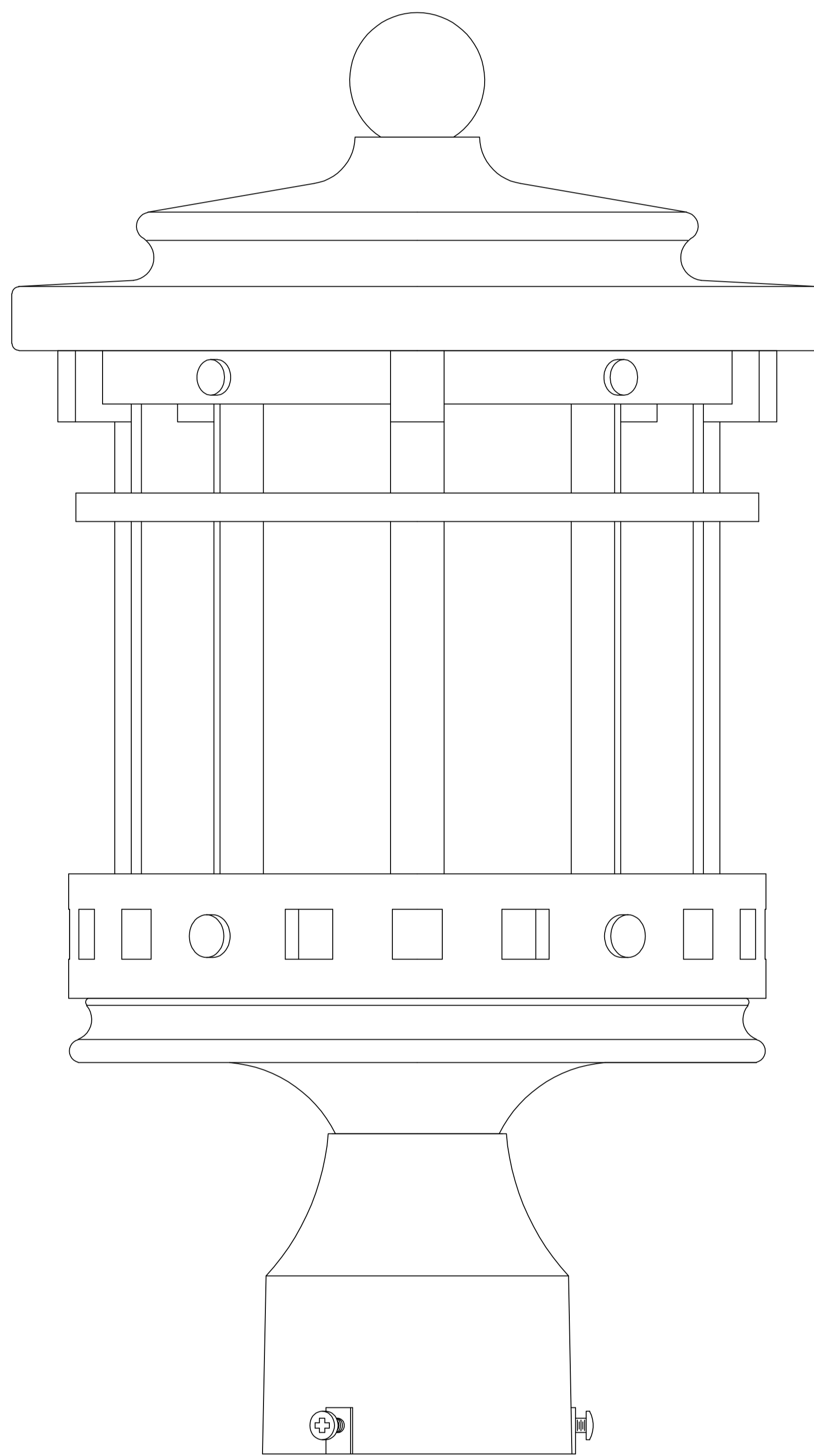

PRODUCT NAME: Santa Barbara
ITEM NUMBER: 65036

Please consult your electrician for hanging fixture and wiring.



To prevent water intrusion, caulk around the post to prevent water intrusion into the splicing area using outdoor silicone sealant.

Bulb(included): 1×9W E26 LED

MADE IN CHINA



PRODUCT NAME: Santa Barbara
 ITEM NUMBER: 65036

IMPORTANT: Turn off the power at the main fuse or circuit breaker box before starting installation.

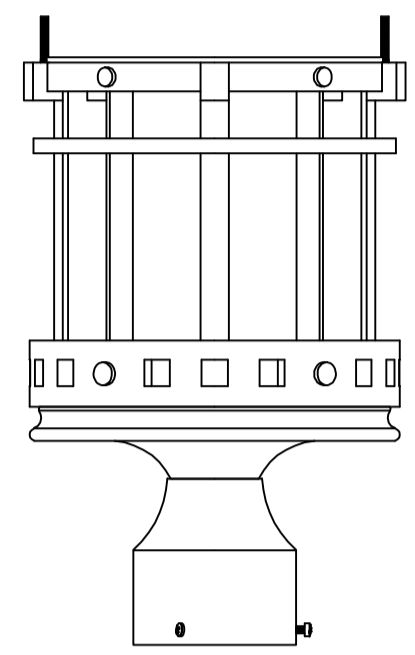

Fixture (A)

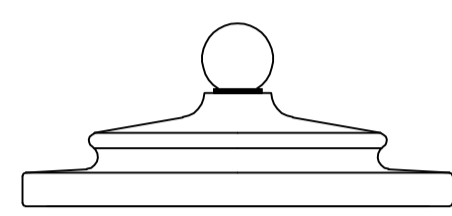

Hood (B)

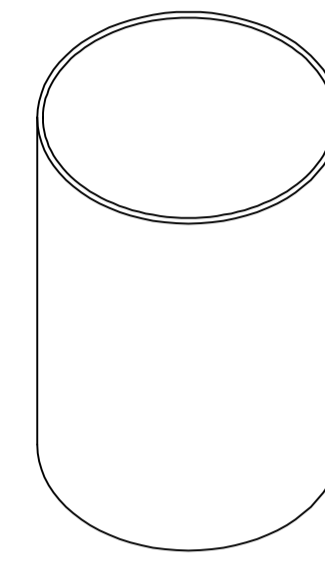

Glass shade (C)

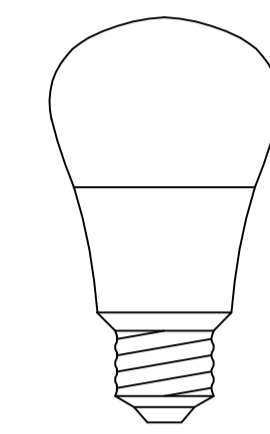

E26 LED Bulb (D)

Locate all hardware & components before discarding packaging

1.)

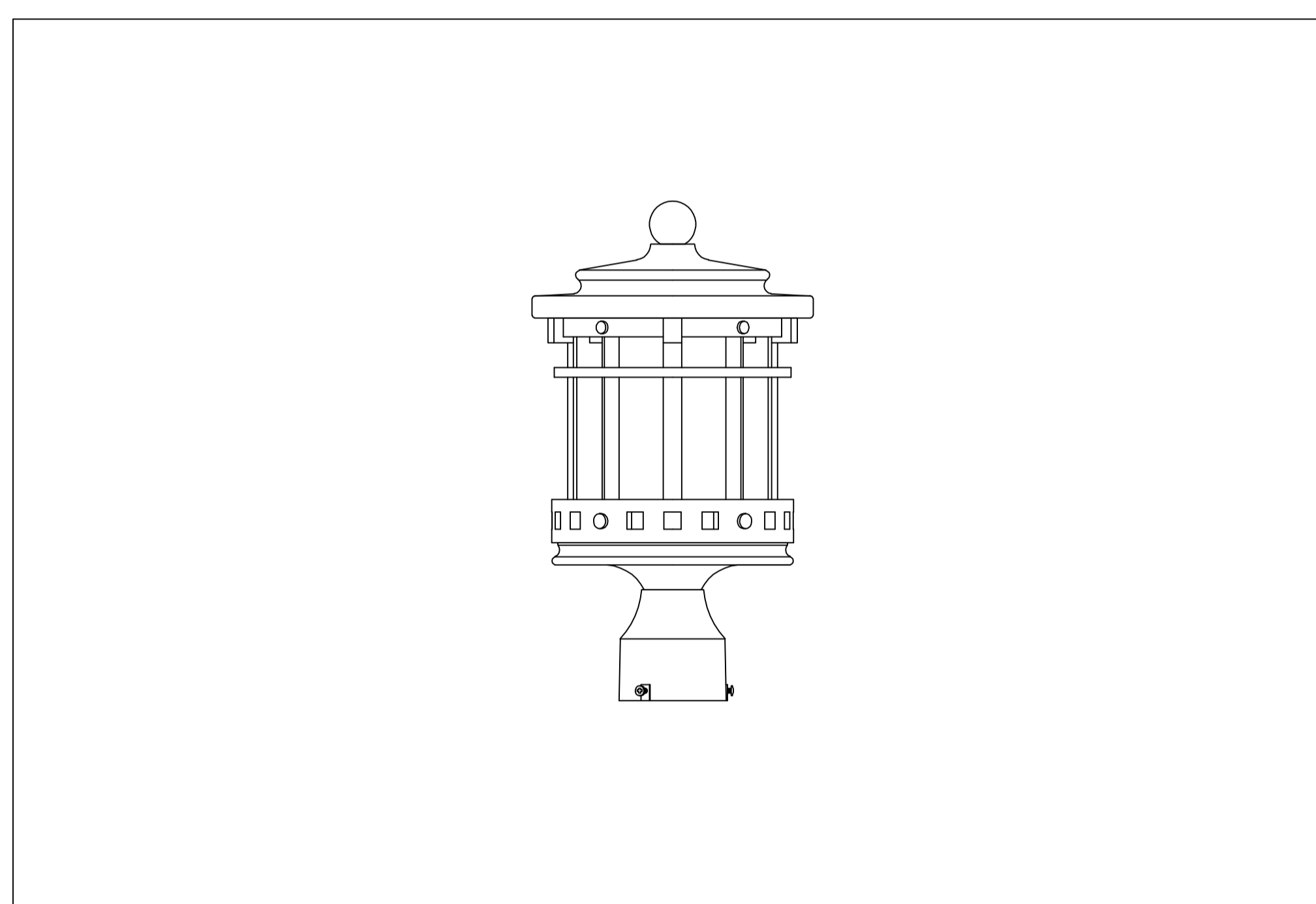

Step.1: Remove hood from the post by unscrewing top finial and two screws within the hood.

3.)

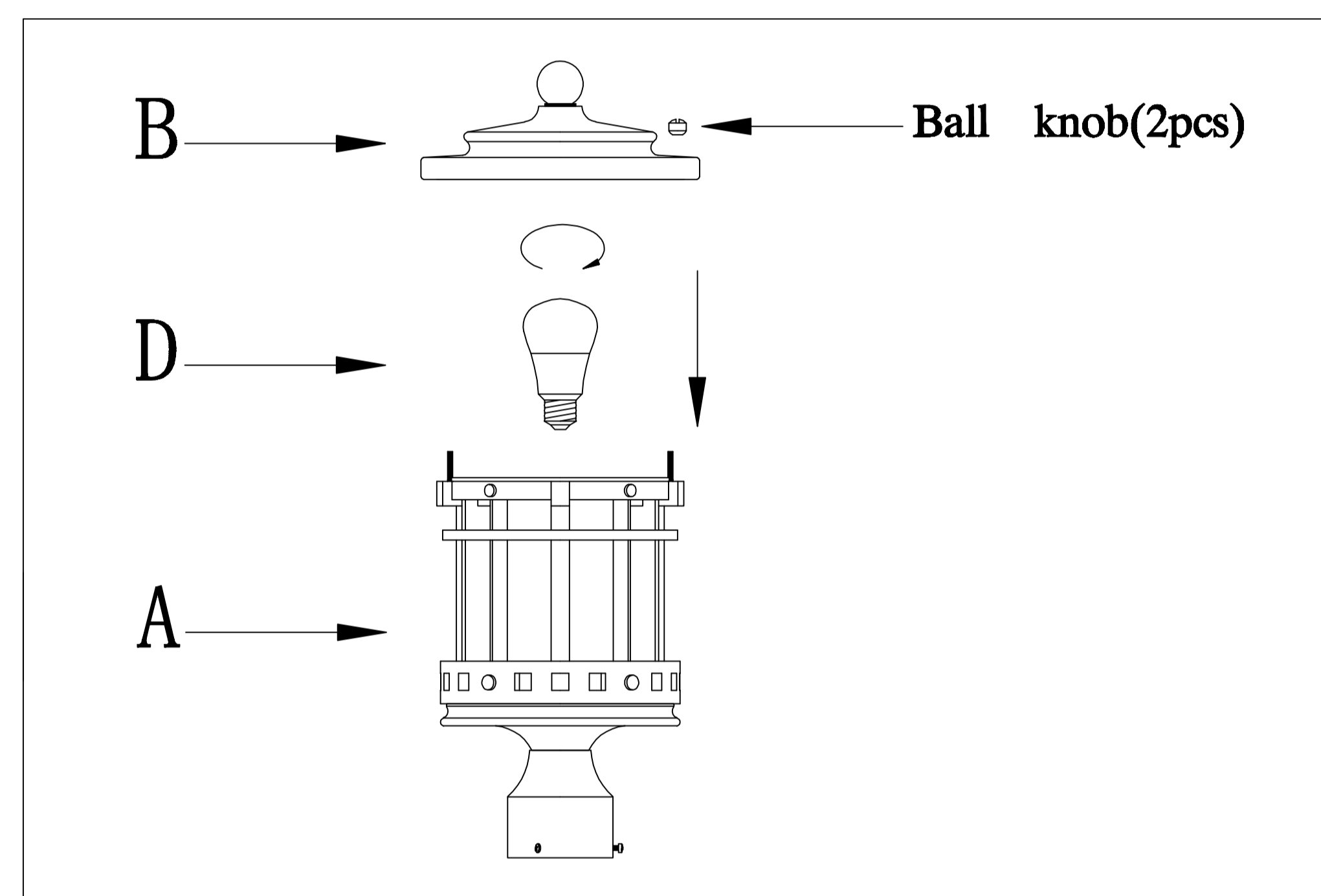

Step.3: Install E26 LED bulb(D), Attach the hood(B) to fixture , using ball knobs .

2.)

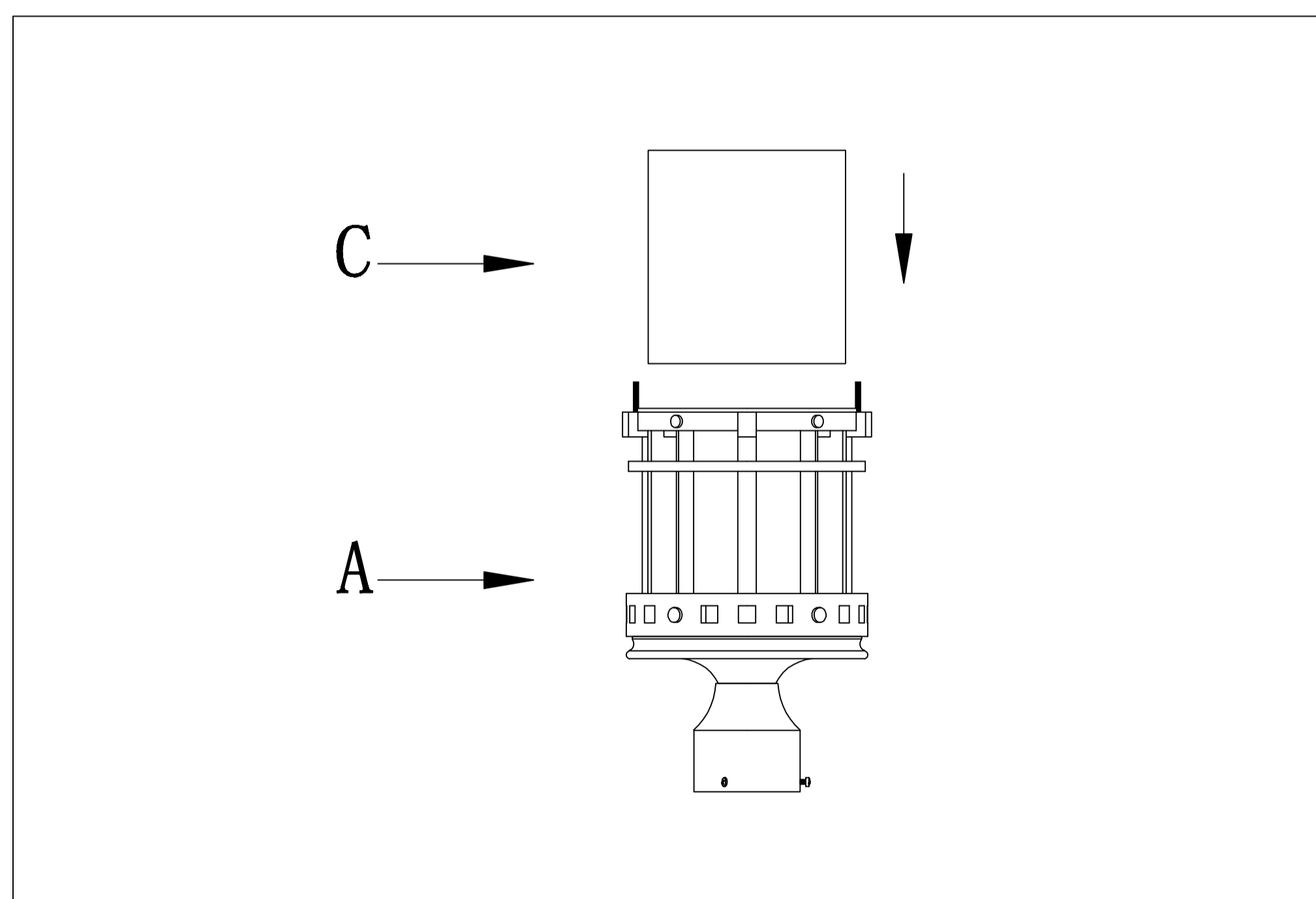

Step.2: Install the glass shade(C) into the fixture.

Step.4: Wire fixture to supply circuit in the post mount.

Step.5: Secure the fixture to the post using three screws on the post mount fitting.

Step.6: Caulk around the post using RTV silicone sealant to prevent water intrusion into the splicing area.

Cleaning & Care:

Clean with soft cloth and a mild detergent.
 Do not use abrasive cleaner.

MADE IN CHINA