

LED Exterior Pendant

EP68428
INSTALLATION SHEET

START FROM HERE

- Make sure power is completely off at the fuse box.
- Have your fixture installed by a qualified licensed electrician
- Prepare everything in a clear area.
- Wear gloves at all times during this installation.
- Read instructions carefully before you start assembly.
- Keep this instruction sheet for future reference.

Technical Support: 1-855-855-8926

Please Note:

- All Kuzco LED fixtures come with pre-wired LED module(s).
- Unless instructed to do so, please do not touch any part of the LED module(s) as any unnecessary contact with the module could cause permanent damage.
- For dimming, an ELV (Electronic Low Voltage) type of dimmer is required.
- Must be installed on a covered ceiling.
- 120V input

- 1.** Remove the fixture from its original packaging. Remove the mounting plate (1c) from within the canopy (2a) by removing the decorative nuts (2b). Secure the mounting plate (1c) to the junction box (1a) with the screws (1e) provided in the hardware package.
- 2.** Before you mount the canopy to the mounting plate select the desired length you wish the pendant to hang. To shorten or lengthen the fixture just push in the canopy nipple (2c) and push/pull the wire to lengthen or shorten. Release to the nipple and this will secure the wire in place. Loosen the screw (2d) and adjust the wire accordingly. Tighten the screw back to secure the wire in place.
- 3.** You are now ready to mount the canopy (2a) to the mounting plate (1c). First connect all wires correctly G ground to ground, N neutral wire (white to white), L live wire (black to black) with provided marettes (1b) from the hardware package. Align the threaded screws (1d) hanging downward from the mounting plate to the holes inside the canopy (2a). Push the canopy up towards the ceiling so the two screws clear through the hole in the canopy (2a). You can now screw on the decorative nuts (2b) onto the threaded studs (1d) to secure the canopy to the mounting plate (1c).
- 4.** To prevent moisture from entering the outlet box and causing a short, seal around the top perimeter between the fixture and the surface with weather resistant caulking (see illustration 1).
- 5.** You have now completed the installation of your fixture, enjoy.

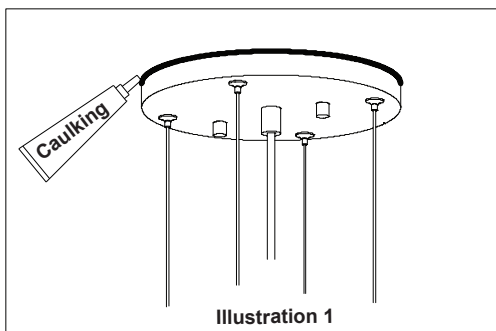
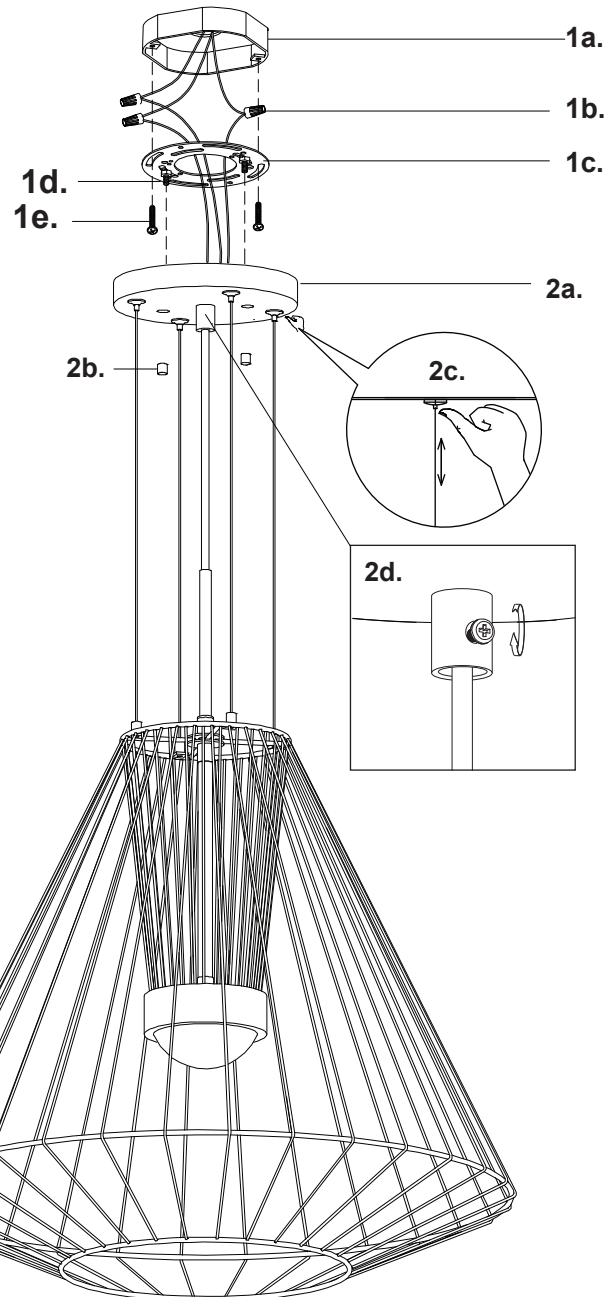

KUZCO

19054 28th Avenue Surrey, BC Canada V3Z 6M3
T: 604 538 7162 TF: 1-855 85 KUZCO F: 604 538 7196
W: kuzcolighting.com
20181127