

**CAUTION – RISK OF SHOCK –**  
Disconnect Power at the main circuit breaker panel or main fusebox before starting and during the installation.

**WARNING:**  
This fixture is intended for installation in accordance with the National Electrical Code (NEC) and all local code specifications. If you are not familiar with code requirements, installation by a certified electrician is recommended.

- 1) Pass fixture wire from the coupling[1] on top of fixture through a stem[2] and threaded tubes[3] and screw stem into coupling. **NOTE:** Thread locking compound must be applied to all stem threads as noted with symbol ( ▶ ) to prevent accidental rotation of fixture during cleaning, relamping, etc.
- 2) Pass fixture wire through desired amount of stems and screw stems together using supplied short threaded tubes[3].
- 3) Pass fixture wire through threaded tube and into Canopy[4].
- 4) Find the appropriate threaded holes on mounting strap[7]. Assemble mounting screws[8] into threaded holes.
- 5) Attach mounting strap to outlet box[6]. The mounting strap can be adjusted to suit position of fixture using the strap mounting screws[9].
- 6) Grounding instructions: (See Illus. A or B).
  - A) On fixtures where mounting strap is provided with a hole and two raised dimples. Wrap ground wire from outlet box around green ground screw, and thread into hole.
  - B) On fixtures where a cupped washer is provided. Attach ground wire from outlet box under cupped washer and green ground screw, and thread into mounting strap.
 If fixture is provided with ground wire. Connect fixture ground wire to outlet box ground wire with wire connector. (Not provided.) After following the above steps. Never connect ground wire to black or white power supply wires.

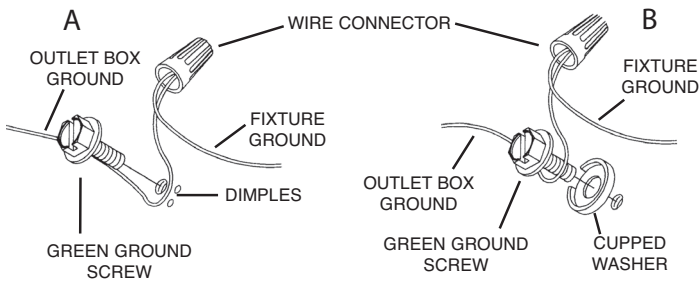

- 7) Make wire connections. Reference chart below for correct connections and wire accordingly.

Connect Black or Red Supply Wire to:	Connect White Supply Wire to:
Black	White
*Parallel cord (round & smooth)	*Parallel cord (square & ridged)
Clear, Brown, Gold or Black without Tracer	Clear, Brown, Gold or Black with Tracer
Insulated wire (other than green) with copper conductor	Insulated wire (other than green) with silver conductor

**\*Note:** When parallel wire (SPT I & SPT II) are used. The neutral wire is square shaped or ridged and the other wire will be round in shape or smooth (see illus.)

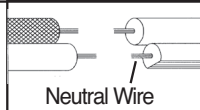

- 8) Push fixture to ceiling, carefully passing mounting screws through holes in canopy. **NOTE:** Be certain wires do not get pinched between canopy and ceiling.
- 9) Use knobs[5] to secure canopy. Tighten to secure.

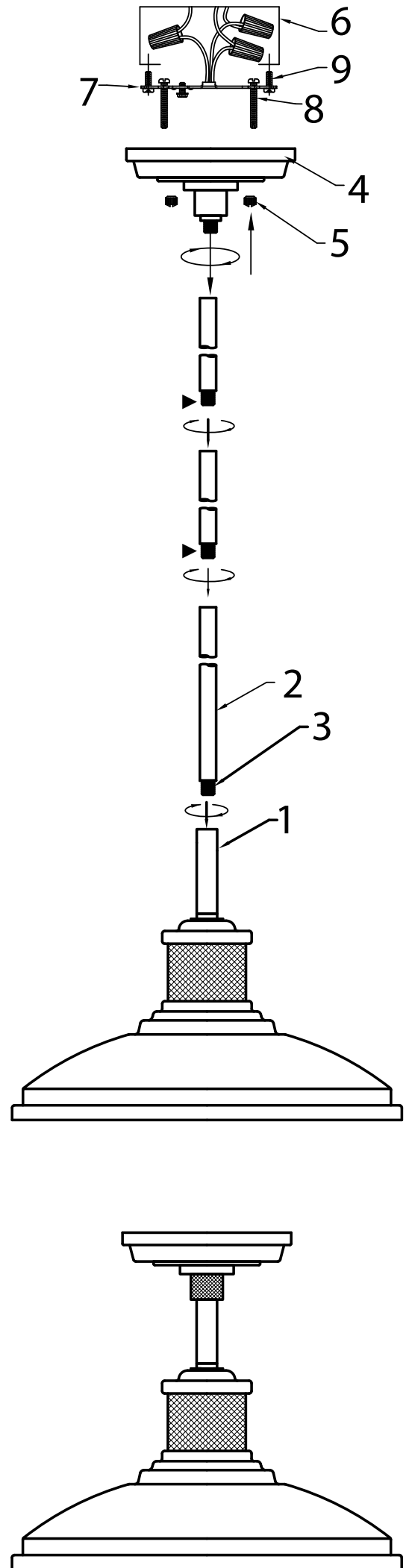

MINIMUM MOUNTING

**ATTENTION – RISQUE DE DÉCHARGES ÉLECTRIQUES -**  
Couper le courant au niveau du panneau du disjoncteur du circuit principal ou de la boîte à fusibles principale avant de procéder à l'installation.

**ATTENTION:**

Ce luminaire doit être installé conformément aux codes d'électricité nationaux (NEC) et satisfaire toutes les spécifications des codes locaux. Si vous ne connaissez pas les exigences de ces codes, il est recommandé de confier l'installation à un électricien certifié.

- 1) Passer le fil de fixation de l'accouplement[1] au-dessus du luminaire à travers une tige[2] et des tubes filetés[3] et visser la tige dans l'accouplement.  
**REMARQUE:** le composé de verrouillage de filetage doit être appliqué à tous les fils de la tige comme indiqué avec un symbole fléché pour empêcher la rotation accidentelle du luminaire pendant le nettoyage, la relamping, etc.
- 2) Passer le fil de fixation à travers la quantité souhaitée de tiges et la visdérive en utilisant des tubes à filetage court fournis[3].
- 3) Pass fixture wire through threaded tube and into Canopy[4].
- 4) Trouvez les trous taraudés appropriés sur sangle de fixation[7]. Monter les vis de montage[8] dans les trous filetés.
- 5) Attachez la sangle de fixation à la boîte de sortie[6]. Sangle de fixation peut être ajustée en fonction de la position de montage[9].
- 6) Connecter les fils. Se porter au tableau ci-dessous pour faire les connexions.

Connecter le fil noir ou rouge de la boîte	Connecter le fil blanc de la boîte
A Noir	A Blanc
*Au cordon parallèle (rond et lisse)	*Au cordon parallèle (à angles droits et strié)
Au transparent, doré, marron, ou noir sans fil distinctif	Au transparent, doré, marron, ou noir avec un til distinctif
Fil isolé (sauf fil vert) avec conducteur en cuivre	Fil isolé (sauf fil vert) avec conducteur en argent

\*Remarque: Avec emploi d'un fil parallèle (SPT I et SPT II). Le fil neutre est à angles droits ou strié et l'autre fil doit être rond ou lisse (Voir le schéma).

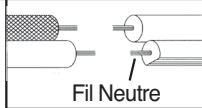

- 7) Poussez fixation au plafond, en passant soigneusement les vis de montage à travers des trous dans la canopée.
- 8) Utilisez les boutons de verrouillage[5] pour sécuriser la canopée. Serrez pour sécuriser.

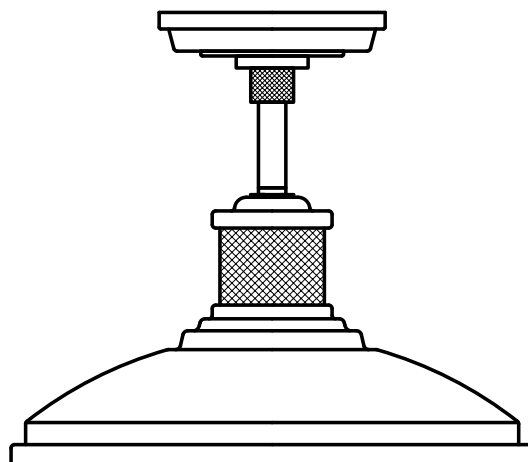
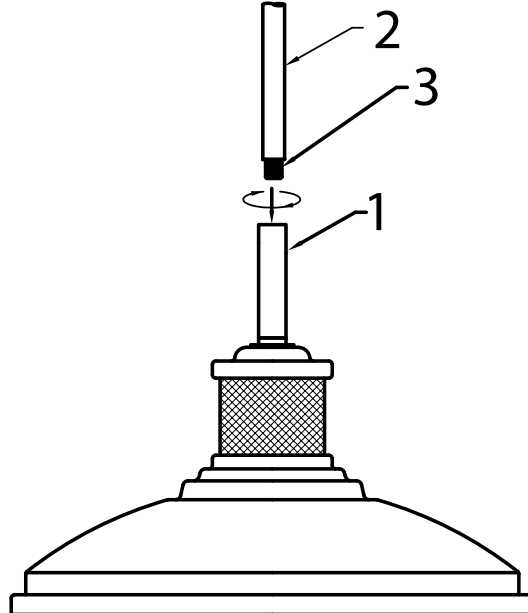
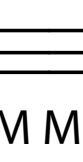
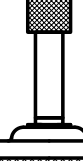
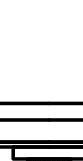
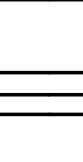
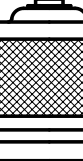
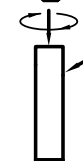
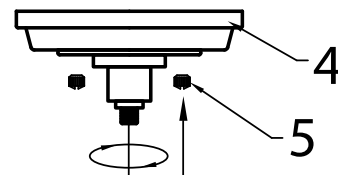
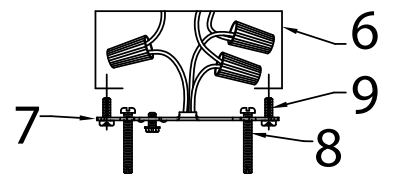

MINIMUM MOUNTING