

**DESIGN COPYRIGHT – 12/21/2022**  
**ALL RIGHTS RESERVED AND MAY**  
**NOT BE DUPLICATED WITHOUT OUR**  
**WRITTEN PERMISSION**

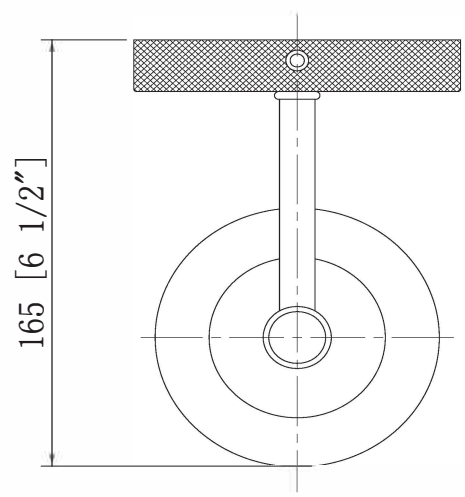
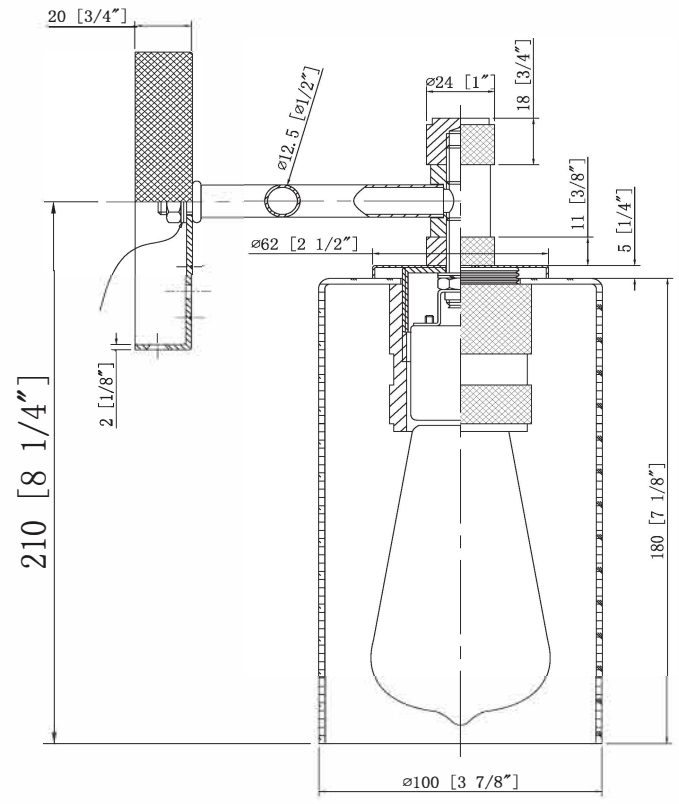
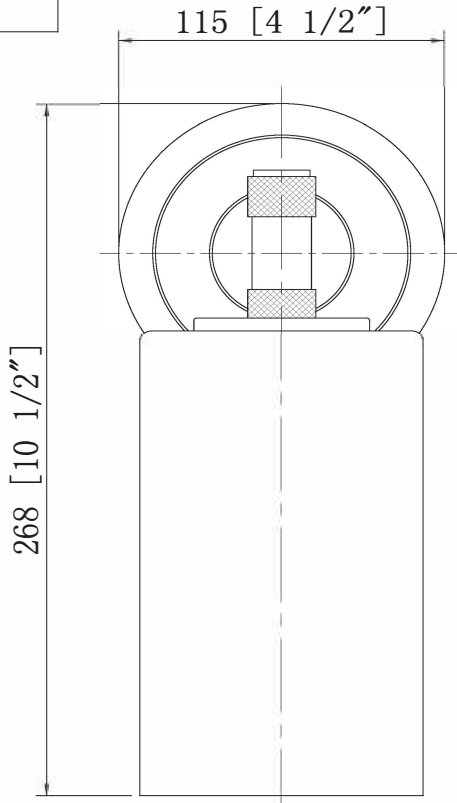
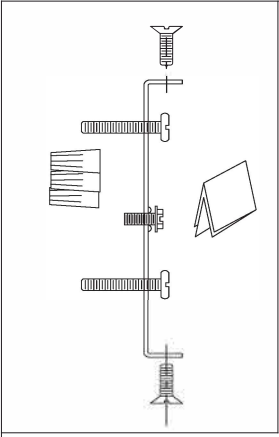

**ITEM: 434-1W-7**