



# TRAK™ 72

## POWER & EFFICIENCY

---

Input Power Options: 120v

Current at Max Speed: 1.16 Amps

Power: 0.13 hp

Maximum Speed: 8 mph

Maximum Affected Area: 24 ft. diameter / 576 sq. ft.

## MODELS

76015

76016

76017

## DIMENSIONS & WEIGHT

---

Fan Diameter: 72 inches

Fan Weight: 48 lbs

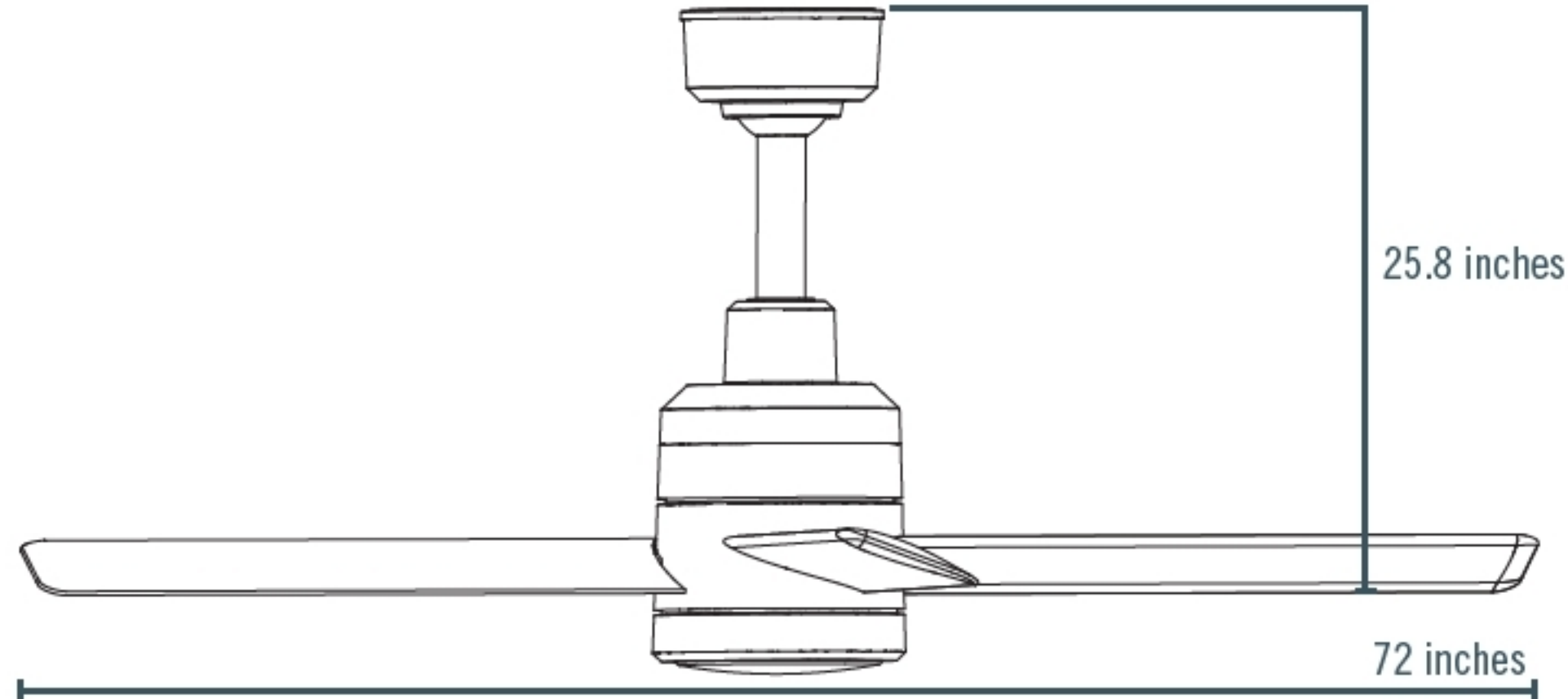

## MOUNTING & SAFETY

---

Mounting Options: Standard / Angled

Downrod: 11" Down Rod

Safety Features:

## INCLUDED IN THE BOX

---

Included: Wall Control, 11" Down Rod

Optional: Handheld Control

Down Rod Sizes: 24", 36", 48", 60", 72"

## WARRANTY & CERTIFICATIONS

---

Certifications: ETL/Intertek-certified to ANSI/UL 506 and CSA C22.2 No. 113 in North America

Indoor/Outdoor/Wet Rating: IP45

Warranty<sup>1</sup>: 3-Year Warranty on Parts