

PREPARING FOR INSTALLATION

Carefully remove all contents from the carton. Shut off the power at the circuit breaker and completely remove the old fixture from the ceiling, including the old mounting bracket. Remove the new mounting bracket assembly from the bag. Remove cap nuts (H) from mounting screws (B). Place the mounting plate (A) over the junction box so that mounting screws (B) and nuts (C) extend out away from the ceiling. Adjust the position of mounting screws (B) so that mounting screws (B) can be exposed 5-6 mm after passing through the canopy (F) to properly fit the cap nuts. Depending on the placement of your junction box the position of mounting screws (A) may need to be adjusted to allow the canopy to be flush with the ceiling. Mounting screws (B) can be adjusted by loosening nuts (C) and loosening or tightening mounting screws (B). Once the ideal position of mounting screws (B) has been confirmed, tighten nuts (C) on mounting screws (B) on the front of the mounting plate to ensure that mounting screws (B) are secure. Pull the house wires through the center of mounting plate (A). Secure mounting plate (A) to the junction box by tightening the screws (D).

ASSEMBLING THE FIXTURE

1. FOR PENDANT INSTALLATION:

There are 4 12-inch rods (K), and 1 6-inch rod (I) included for each fixture. Determine the correct number of rods needed for proper hanging height. To lengthen the fixture, add additional rods. To shorten the fixture, trim the wires to desired length. Leave at least 8 to 10 inches of wire in addition to the desired length and slide any excess rods off the fixture's wiring to discard. Keep in mind that you must use at least one rod to hang the fixture. Thread the wires through the rods and pull the wires until taut before connecting the rods together. All threads should be engaged but do not overtighten (some manual straightening of the downrods may be required). Screw the rod (K or I) on the threaded post of fixture (L). Pull the fixture wires through the top of the canopy (F). Screw the top rod to hang straight (G) of canopy (F). To install on a sloped ceiling, make sure that the notched side of hang straight (G) faces away from the peak of the ceiling (twist into place if needed). Once attached to the junction box, grasp the rods firmly with both hands and gently pull toward the notch until the fixture is at the desired angle.

2. FOR SEMI-FLUSH INSTALLATION:

Unscrew the hex nut (J) inside the canopy (F) and set hex nut (J) aside. Remove the hang straight (G) from the canopy (F). Pass the wires and threaded post of fixture (L) through canopy (F) and secure it with the hex nut (J) inside canopy (F).

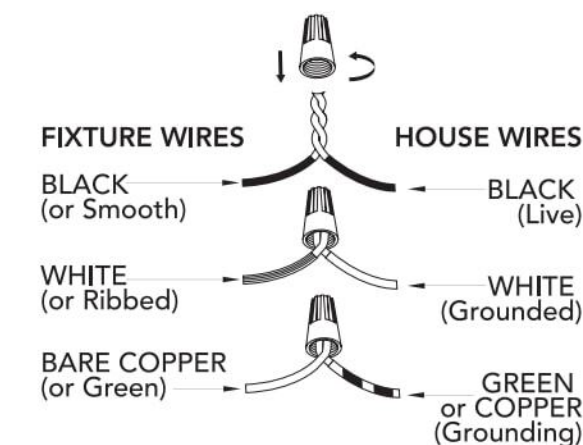

CONNECTING THE WIRES

Have a helper support the fixture's weight while completing the wiring. Attach the fixture's wires to the power supply wires from the junction box. Connect black to black (live); white to white (neutral); grounding to grounding (green or copper). Twist the ends of the wire pairs together. Then, twist on a wire connector. Make sure all twists are in the same direction. Loop fixture's ground wire around grounding screw (E) and tighten. If there is no ground wire (green or copper) from the junction box, contact a qualified electrician.

FINISHING THE INSTALLATION

Raise canopy (F) to mounting plate (A) and position mounting screws (B) so that they protrude through the openings of canopy (F). Secure canopy (F) in place with cap nuts (H). Then use the socket ring (N) to secure the glass shade (M) to the socket. Install light bulb (not included) in accordance with the fixture's specifications. Do not exceed the recommended wattage. Your installation is now complete. Turn on the power and test the fixture.

CLEANING TIPS

Treat the fixture gently! Regular cleaning will reduce the need for deep cleaning. For regular cleaning, turn off the light and wipe down the fixture with a clean lint-free cotton or microfiber cloth. Never spray cleaner directly onto the fixture.

NOTICE

In order to use a 12in. rod by itself you must first remove the threaded post from the 6in. rod and install it on one of the ends of the 12in. rod.



Hunter Pro Tip:

Twist or tape wire ends together to make it easier to pass them through the downrods. Threaded post may also be removed for easier wire access.

Hunter

Xidane

For Models:
Para los Modelos:
Pour les Modèles:
19767
19768
19512

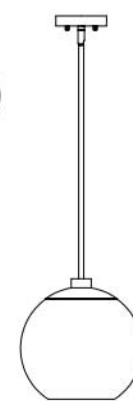
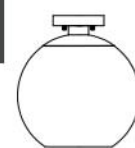

Here are the tools you'll need to complete your installation:

Estas son las herramientas que usted necesitará para completar su instalación:

Voici les outils dont vous aurez besoin pour réaliser l'installation:



Ladder
Escalera
Échelle

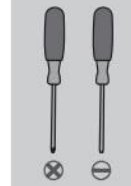

Screwdriver
Destornillador
Tournevis



Pliers
Alicates
Pince

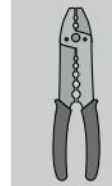

Wire Strippers
Pelacables
Pince à dénuder

1 Light Pendant
1 Luz Colgante
1 Lumière Chaînette

Fixture weight ±2 lbs:
Peso ±2 lb: 7.3 lbs (3.3 kg)
Poids fixe ±2 lbs:

Hardware Service Kit/Kit De Mantenimiento Del Equipo/Trousse De Maintenance Quincallerie

Part #/Pieza #/Pièce #	Model/Modelo/Modèle	Finish/Finish/Fini
KE19501L24	19767	Alturas Gold/Alturas Gold/ Or d'Alturas
KE19501214	19768	Brushed Nickel/Niquel Pulido/ Nickel Brossé
KE19501895	19512	Matte Black/Negro Mate/ Noir Mat

Glass/Domo De Vidrio/Verre

Part #/Pieza #/Pièce #	Model/Modelo/Modèle	Type/Tipo/Type
	19767	Clear Glass/ Vidrio Transparente/ Verre Transparent
KE28501147	19768 19512	

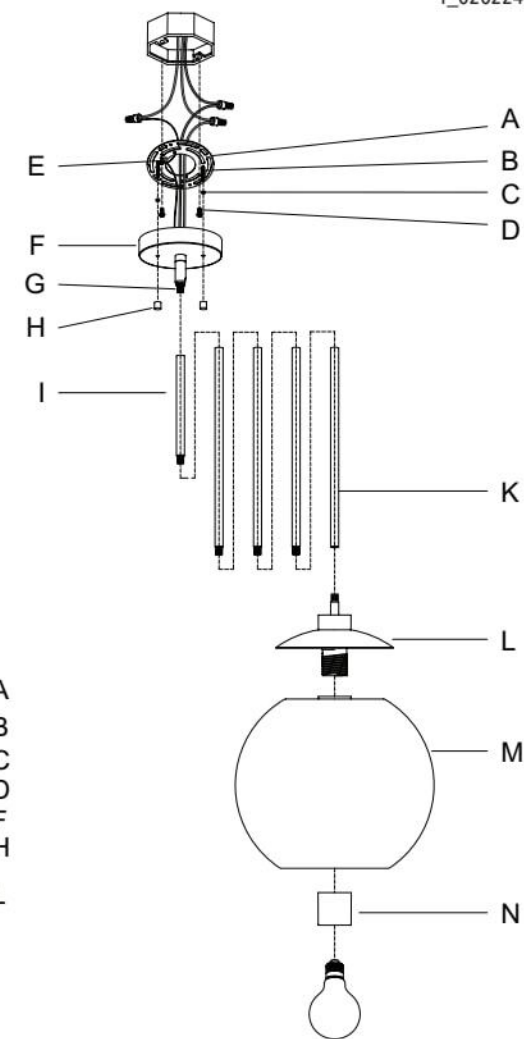
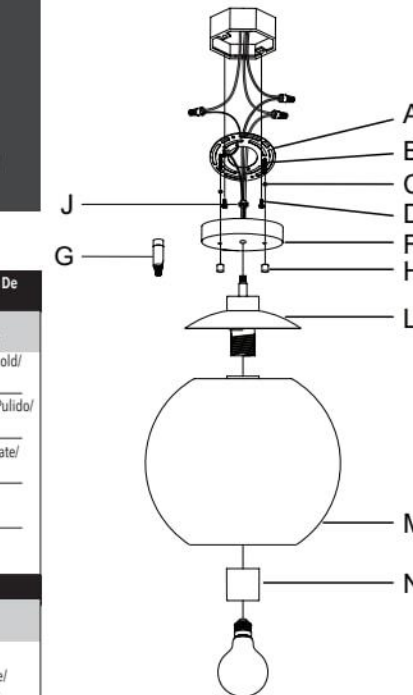

INSTALLATION INSTRUCTIONS INSTRUCCIONES DE INSTALACIÓN/ INSTRUCTIONS D'INSTALLATION

WARNING

- To avoid possible electrical shock, before installing your light fixture, disconnect the power by turning off the circuit breakers to the outlet box associated with the wall switch location.
- The lighting fixture must be grounded. If the ground wire for the installation site is not present, immediately **STOP** installation and consult a qualified electrician.
- All wiring must be in accordance with national and local electrical codes ANSI/NFPA 70. If you are unfamiliar with wiring or in doubt, consult a qualified electrician.

READ AND SAVE THESE INSTRUCTIONS
These instructions are provided for your safety. It is very important that they are read carefully and completely before beginning installation of the lighting fixture.

ADVERTENCIA

- Para evitar una posible descarga eléctrica, antes de instalar su lámpara, desconecte la energía apagando los interruptores automáticos (breakers) que alimentan la caja de salida asociada con la ubicación del interruptor de pared.
- La lámpara se debe conectar a tierra. Si el alambre de conexión a tierra no está presente en el sitio de la instalación, **DETENGA** inmediatamente la instalación y consulte con un electricista calificado.
- Todo el cableado debe realizarse de acuerdo con los códigos eléctricos locales y nacionales ANSI/NFPA 70. Si no está familiarizado con el cableado, o si tiene duda, consulte a un electricista calificado.

LEA Y GUARDE ESTAS INSTRUCCIONES
Estas instrucciones se proporcionan para su seguridad. Es muy importante leerlas detenidamente y completamente antes de comenzar la instalación de la lámpara.

AVERTISSEMENT

- Pour éviter tout choc électrique, avant d'installer le luminaire, coupez le courant en éteignant les disjoncteurs de la boîte électrique associée à l'interrupteur mural.
- Le luminaire doit être mis à la terre. Si le fil de terre du lieu d'installation n'est pas présent, **ARRÊTER** immédiatement l'installation et consulter un électricien qualifié.
- Tout le câblage doit être conforme aux codes électriques nationaux et locaux en vigueur et à la norme ANSI/NFPA 70. Si vous n'avez pas l'habitude de faire ce câblage ou en cas de doute, adressez-vous à un électricien qualifié.

LISEZ ET CONSERVEZ CES INSTRUCTIONS
Ces instructions sont fournies pour votre sécurité. Il est très important de les lire attentivement dans leur intégralité avant d'entreprendre l'installation du luminaire.