

Installation Instructions

CAUTION: FAILURE TO INSTALL THIS FIXTURE PROPERLY MAY RESULT IN SERIOUS PERSONAL INJURY OR DEATH AND PROPERTY DAMAGE. We recommend installation by a licensed electrician.

This product must be installed in accordance with applicable installation code(s), by a person familiar with the construction and operation of the product and the hazards involved.*

Caution: Do not exceed maximum wattage noted on fixture. Use only recommended bulbs with fixture.

To Install Fixture to Wall (Figures 1 & 2)

Component Parts

- A Fixture
- B Crossbar
- C 8-32 Screw (2)
- D Ground Screw
- E Caulking Lip

Note: Fixture enclosure to be located four feet above the ground. Caution: Be sure power is off at the main breaker box prior to installation.

1. Carefully unpack the fixture from the carton.
2. Using two machine screws (not provided) attach crossbar (B) to the electric box using outer oval holes to orient fixture.
Note: A new electric box comes with screws. When replacing a fixture, retain the screws for use with the new fixture.
3. Using suitable wire connectors (not provided), connect the fixture wires to the supply wires, (white to white or ribbed and black to black or smooth, and bare copper or green to bare copper or green). Ground the crossbar (B) using the green ground screw (D) to secure a pigtail lead to the bracket.
4. Apply a generous bead of a suitable caulking material to caulking lip (E) on the fixture (Figure 2).
5. Carefully tuck all wires behind the fixture, place fixture firmly against the wall and fasten with 8-32 screws (C). To ensure a water tight seal, apply a thin bead of caulking around entire perimeter of the fixture.

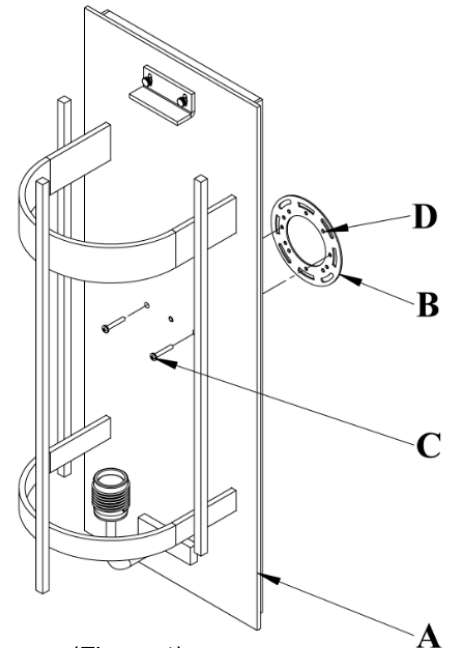

(Figure 1)

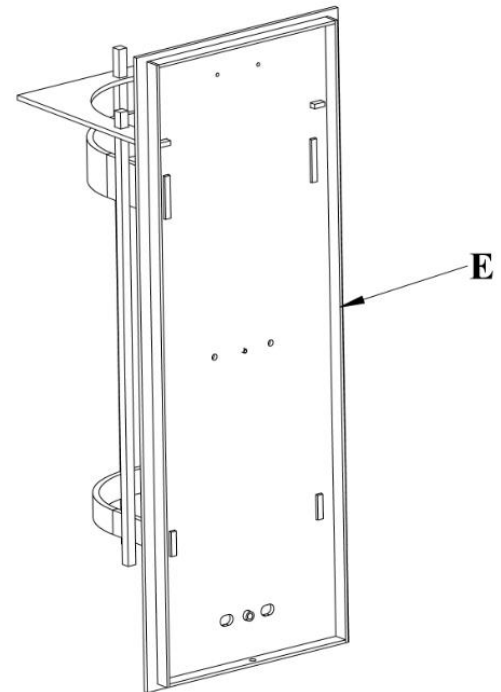

(Figure 2)

(continued)

Installation Instructions

For Outdoor Sconces 30-5895 & 30-5895F

B157

Page 2 of 2

To Install Glass (Figure 4)

Component Parts

- A Fixture
- F Glass Top
- G Thumb Screw (2)
- H Glass

1. Install light bulb. (*Fluorescent fixtures are supplied with bulb.*)
2. Slide glass (H) into fixture (A).
3. Remove the two thumb screws (G) from fixture (A).
4. Attach glass top (F) onto fixture (A) with two thumb screws (G). *Do not tighten thumb screws at this point.*
5. Adjust glass top (F) until it rests on top of glass (H).
6. Tighten by hand thumb screws (G) until snug against glass top (F). (*Be careful not to over tighten*)
7. Restore electricity at the main breaker.

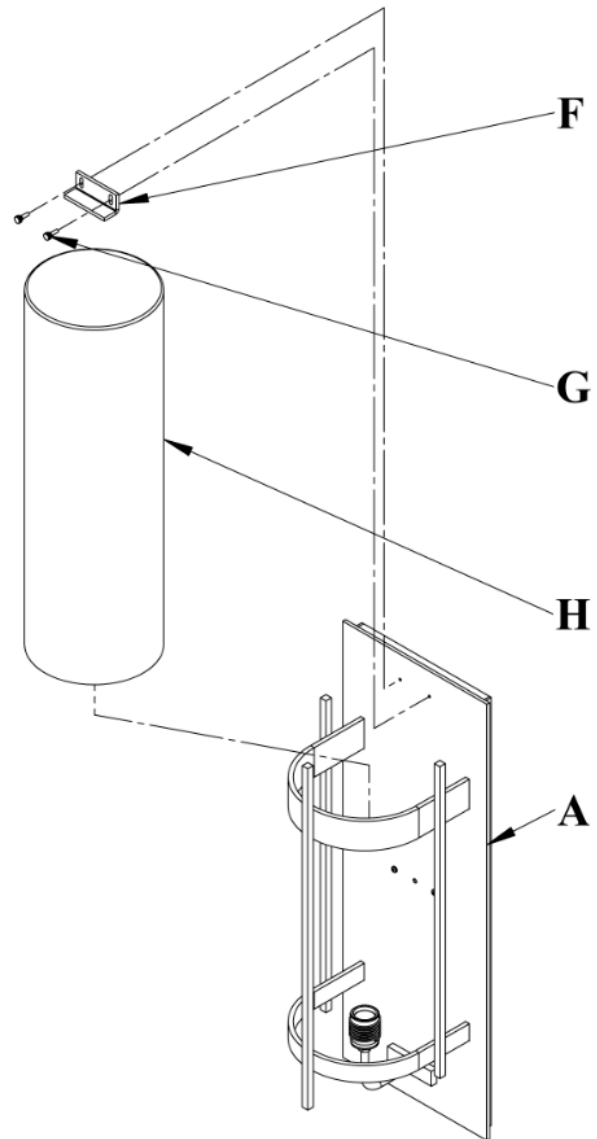

(Figure 3)

If you need further assistance, or find that you are missing any parts, please contact the dealer from which you purchased this product. We hope you enjoy your fixture!

* Hubbardton Forge will not be liable for injury or damage caused by improper installation, lamping or use of this fixture.