

Classic Traditional™

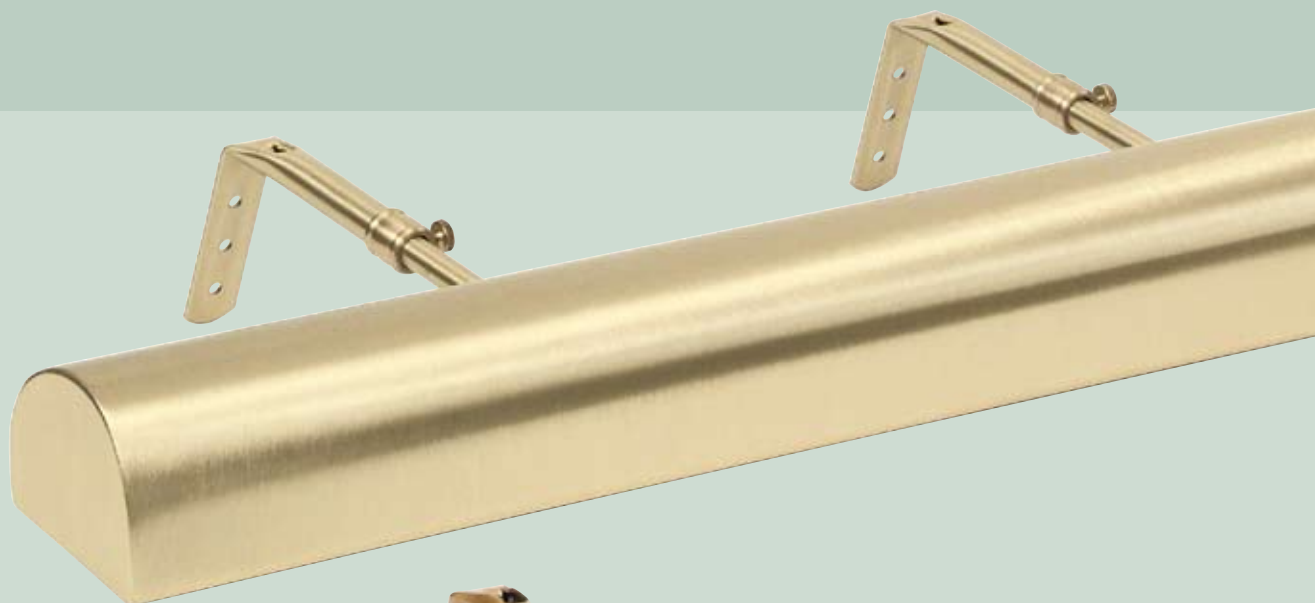

Specifications

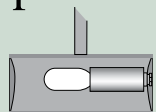

T4" & T5" shades
one 15T7F bulb

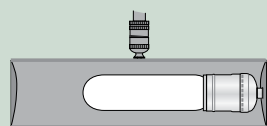

T8" and T9" shades
one 25 or 40T10F bulb

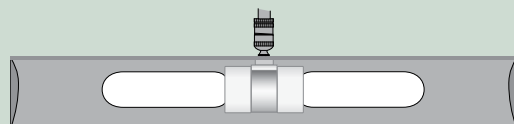

T14" and T18" shades
two 25 or 40T10F bulbs

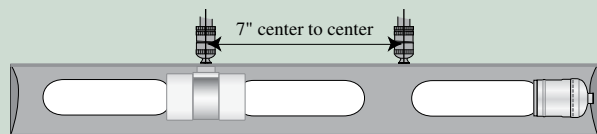

T21" shade
three 25 or 40T10F bulbs

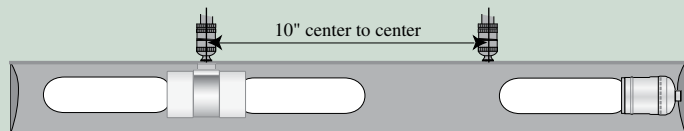

T24" shade
three 25 or 40T10F bulbs

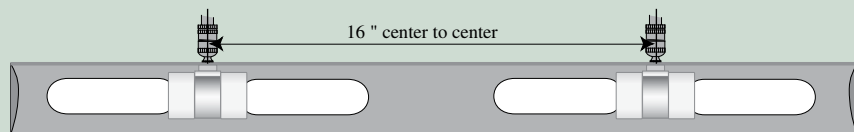

T30" shade
four 25 or 40T10F bulbs

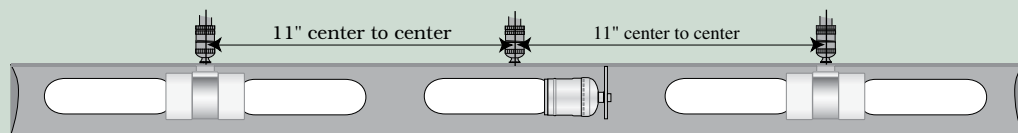

T36" shade
five 25 or 40T10F bulbs

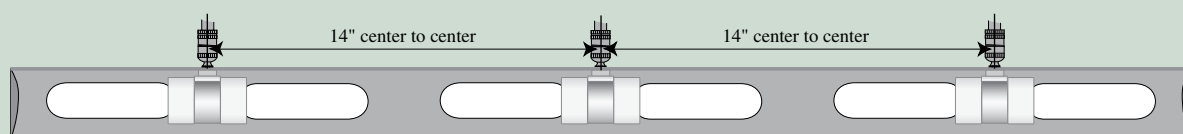

T42" shade
six 25 or 40T10F bulbs

SIZE SELECTION

Shade length should be one half the width of the image it is illuminating.

NOTE:

Traditional Series Picture Lights with more than one arm, have a UL-LISTED, pre-wired, aluminum splice-box (2" x 2" x 5/8") that hangs behind the artwork.

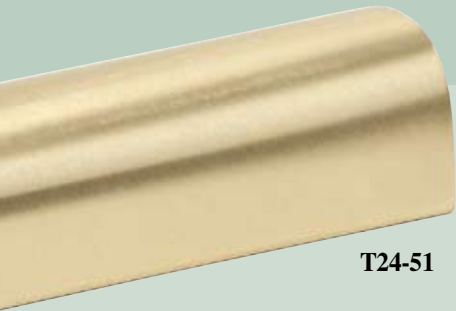

T24-51

Craftsmanship and reliability are traditions at House of Troy.

Finishes

- Gold #1
- Gold Wrinkle #2
- Bronze #5
- Pewter #31
- Satin Brass #51
- Statuary Bronze #56
- Polished Brass #61
- Antique Brass #71
- Weathered Brass #76
- Mahogany Bronze #81

NOTE:
Custom orders
available on request.



T14-1

Features

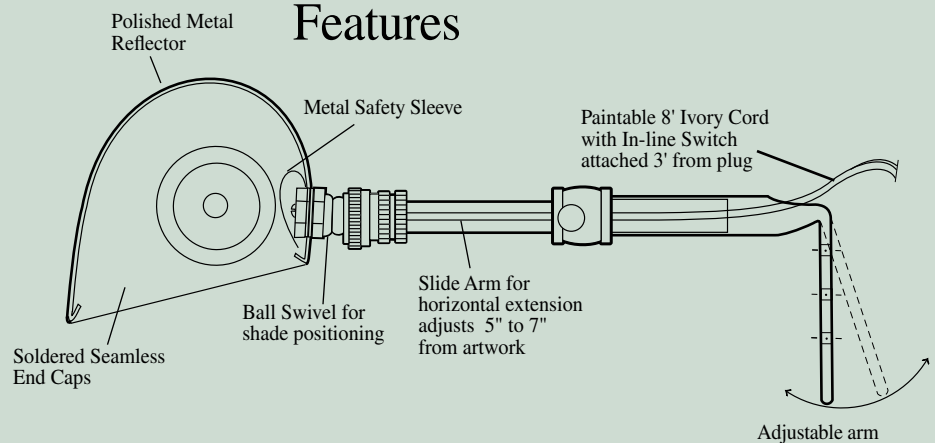

There are 25 procedures involved in the assembly of a Classic Traditional™ picture light. This hands-on assembly process assures a quality product.

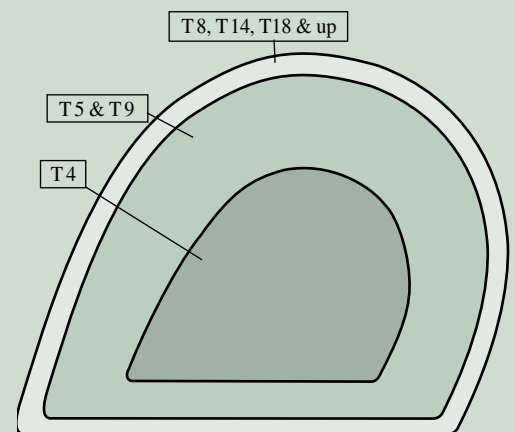

END CAP PROFILES ACTUAL SIZE