

# Classic Traditional™

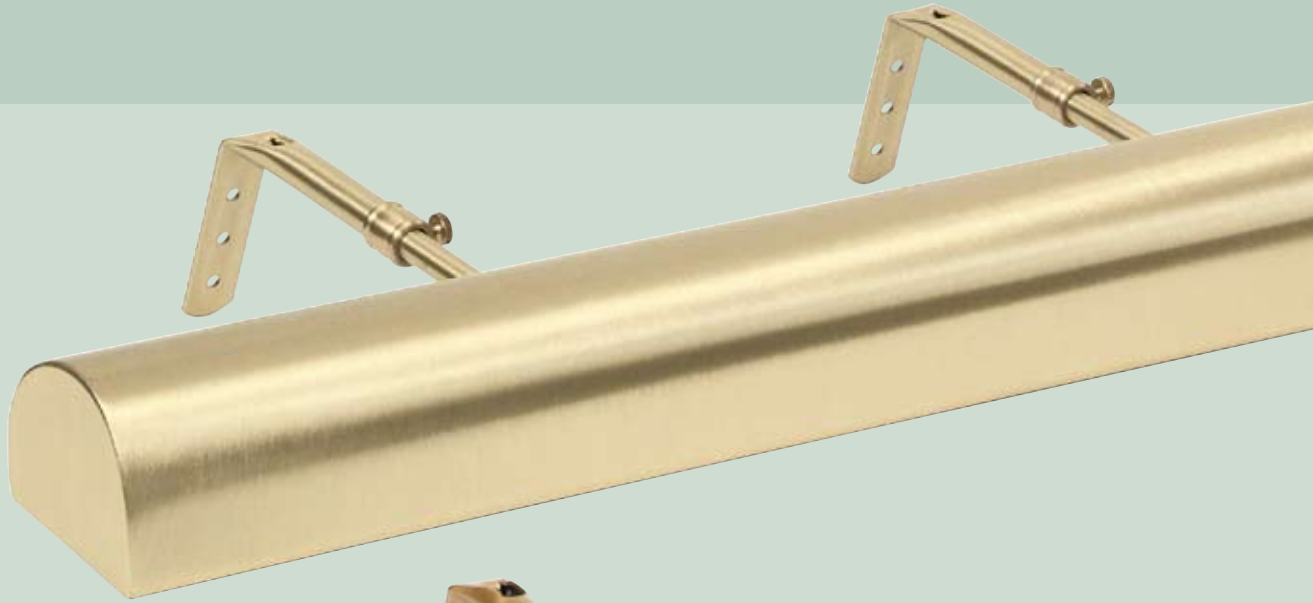

## Specifications

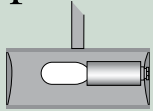

**T4" & T5" shades**  
one 15T7F bulb

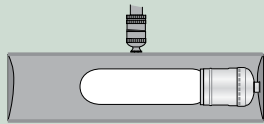

**T8" and T9" shades**  
one 25 or 40T10F bulb

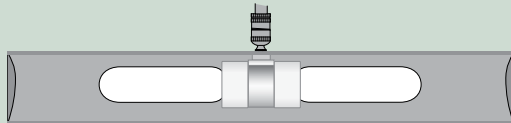

**T14" and T18" shades**  
two 25 or 40T10F bulbs

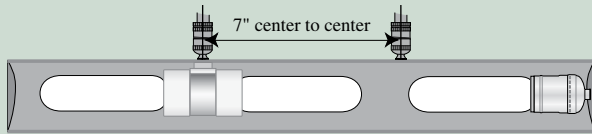

**T21" shade**  
three 25 or 40T10F bulbs

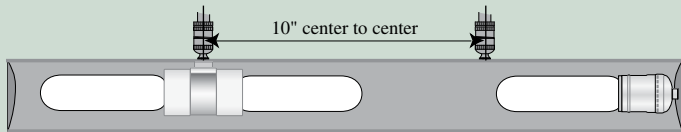

**T24" shade**  
three 25 or 40T10F bulbs

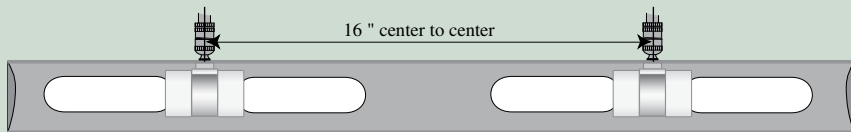

**T30" shade**  
four 25 or 40T10F bulbs

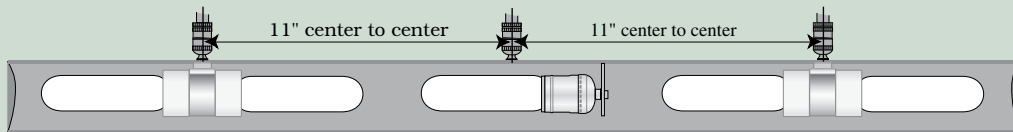

**T36" shade**  
five 25 or 40T10F bulbs

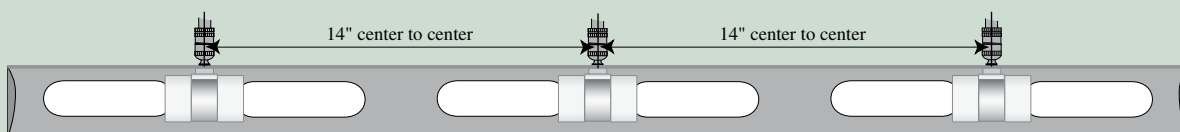

**T42" shade**  
six 25 or 40T10F bulbs

### SIZE SELECTION

Shade length should be one half the width of the image it is illuminating.

### NOTE:

Traditional Series Picture Lights with more than one arm, have a UL-LISTED, pre-wired, aluminum splice-box (2" x 2" x 5/8") that hangs behind the artwork.

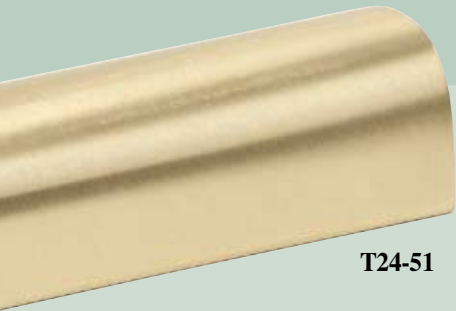

T24-51

## Craftsmanship and reliability are traditions at House of Troy.



T14-1

### Finishes

- Gold #1
- Gold Wrinkle #2
- Bronze #5
- Pewter #31
- Satin Brass #51
- Statuary Bronze #56
- Polished Brass #61
- Antique Brass #71
- Weathered Brass #76
- Mahogany Bronze #81

**NOTE:**  
Custom orders available on request.

### Features

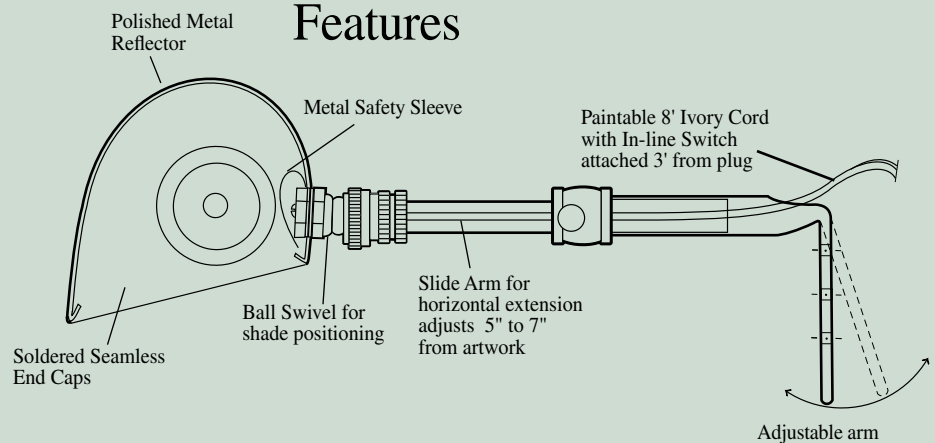

There are 25 procedures involved in the assembly of a Classic Traditional™ picture light. This hands-on assembly process assures a quality product.

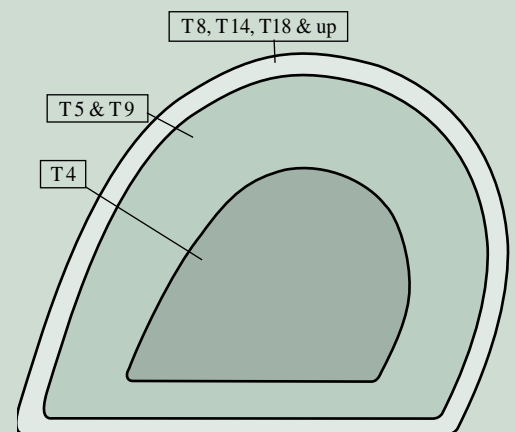

END CAP PROFILES ACTUAL SIZE