

Classic Traditional™

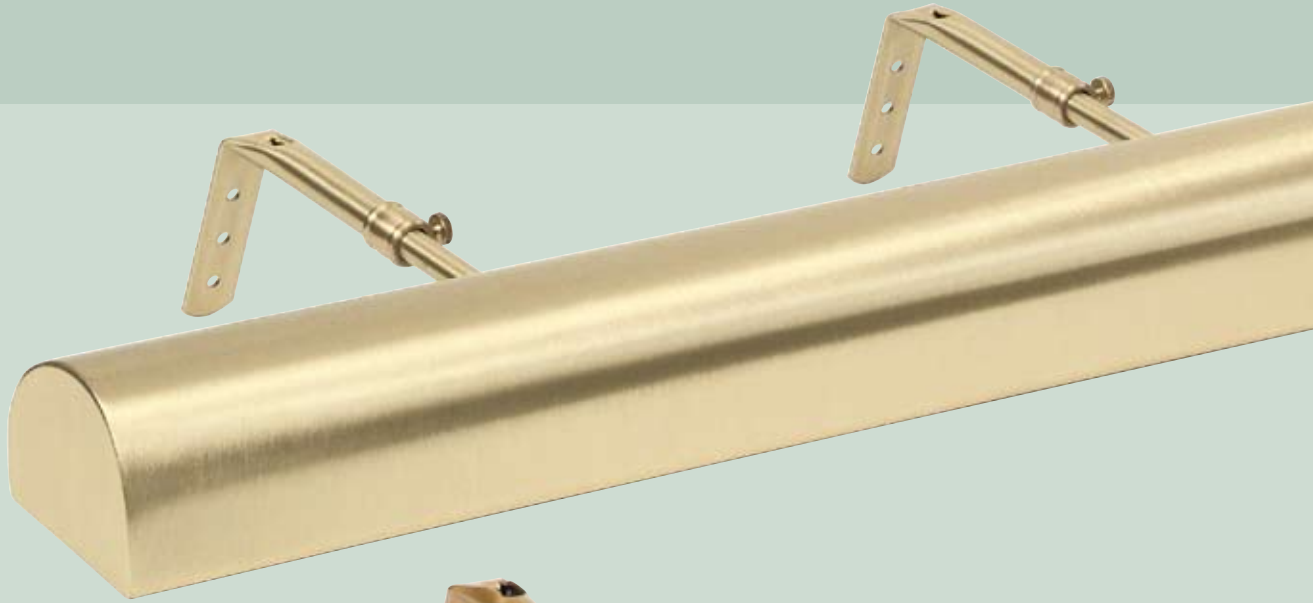

Specifications

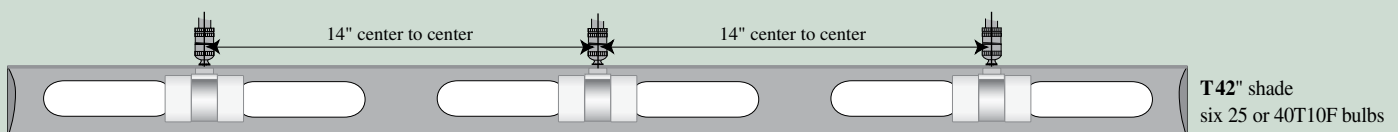
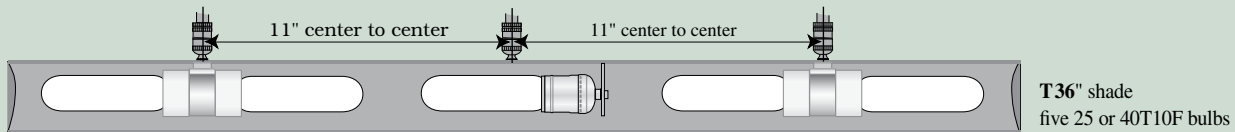
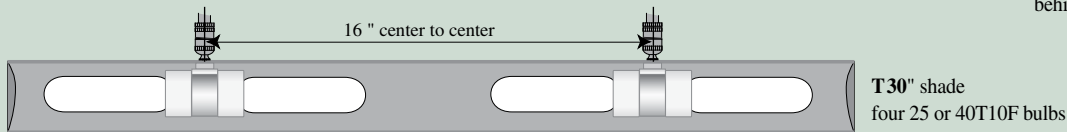
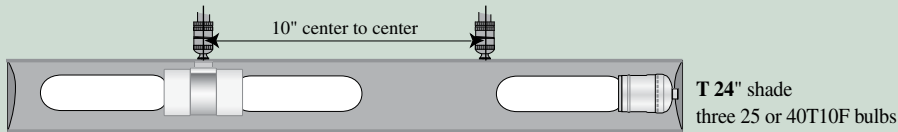
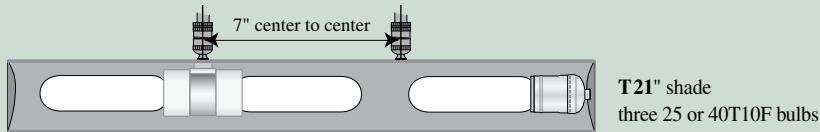
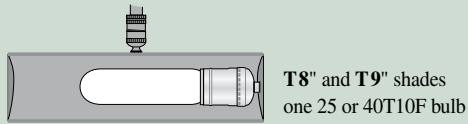
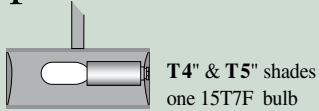

SIZE SELECTION
Shade length should be one half the width of the image it is illuminating.

NOTE:
Traditional Series Picture Lights with more than one arm, have a UL-LISTED, pre-wired, aluminum splice-box (2" x 2" x 5/8") that hangs behind the artwork.

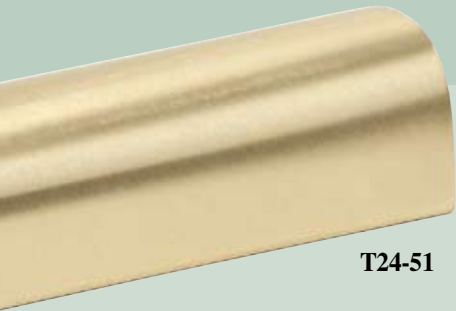

T24-51

Craftsmanship and reliability are traditions at House of Troy.

Finishes

- Gold #1
- Gold Wrinkle #2
- Bronze #5
- Pewter #31
- Satin Brass #51
- Statuary Bronze #56
- Polished Brass #61
- Antique Brass #71
- Weathered Brass #76
- Mahogany Bronze #81

NOTE:
Custom orders
available on request.



T14-1

Features

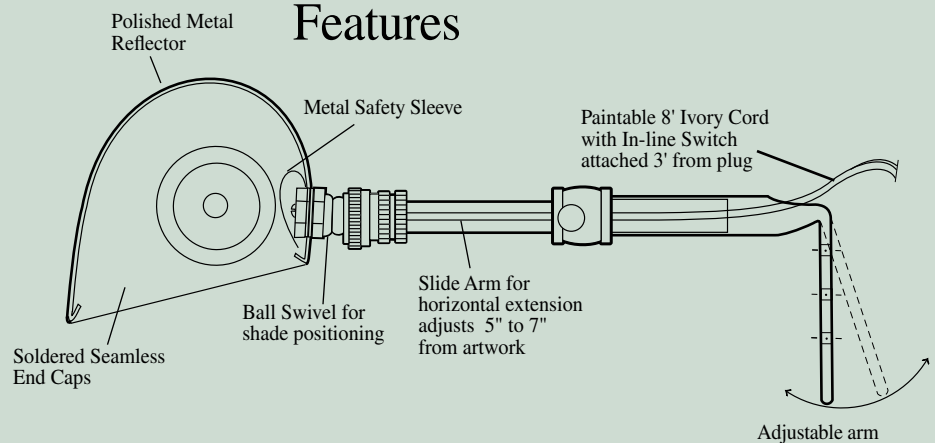

There are 25 procedures involved in the assembly of a Classic Traditional™ picture light. This hands-on assembly process assures a quality product.

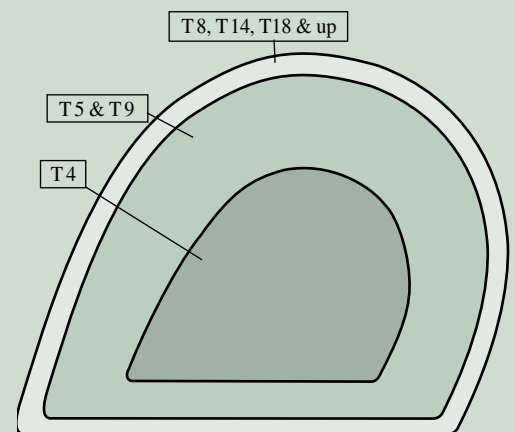

END CAP PROFILES ACTUAL SIZE